



***ELGAR***  
**ETS600X**  
**Photovoltaic Simulator**  
**Operation and Maintenance Manual**  
*Programmable Power Solutions*



## **About AMETEK**

AMETEK Programmable Power, Inc., a Division of AMETEK, Inc., is a global leader in the design and manufacture of precision, programmable power supplies for R&D, test and measurement, process control, power bus simulation and power conditioning applications across diverse industrial segments. From bench top supplies to rack-mounted industrial power subsystems, AMETEK Programmable Power is the proud manufacturer of Elgar, Sorensen, California Instruments and Power Ten brand power supplies.

AMETEK, Inc. is a leading global manufacturer of electronic instruments and electromechanical devices with annualized sales of \$2.5 billion. The Company has over 11,000 colleagues working at more than 80 manufacturing facilities and more than 80 sales and service centers in the United States and around the world.

## **Trademarks**

AMETEK is a registered trademark of AMETEK, Inc.

Other trademarks, registered trademarks, and product names are the property of their respective owners and are used herein for identification purposes only.

## **Notice of Copyright**

*Terrestrial Solar Array Simulator, Operation and Maintenance Manual* © 2010 AMETEK Programmable Power, Inc. All rights reserved.

## **Exclusion for Documentation**

UNLESS SPECIFICALLY AGREED TO IN WRITING, AMETEK PROGRAMMABLE POWER, INC. ("AMETEK"):

- (a) MAKES NO WARRANTY AS TO THE ACCURACY, SUFFICIENCY OR SUITABILITY OF ANY TECHNICAL OR OTHER INFORMATION PROVIDED IN ITS MANUALS OR OTHER DOCUMENTATION.
- (b) ASSUMES NO RESPONSIBILITY OR LIABILITY FOR LOSSES, DAMAGES, COSTS OR EXPENSES, WHETHER SPECIAL, DIRECT, INDIRECT, CONSEQUENTIAL OR INCIDENTAL, WHICH MIGHT ARISE OUT OF THE USE OF SUCH INFORMATION. THE USE OF ANY SUCH INFORMATION WILL BE ENTIRELY AT THE USER'S RISK, AND
- (c) REMINDS YOU THAT IF THIS MANUAL IS IN ANY LANGUAGE OTHER THAN ENGLISH, ALTHOUGH STEPS HAVE BEEN TAKEN TO MAINTAIN THE ACCURACY OF THE TRANSLATION, THE ACCURACY CANNOT BE GUARANTEED. APPROVED AMETEK CONTENT IS CONTAINED WITH THE ENGLISH LANGUAGE VERSION, WHICH IS POSTED AT [WWW.PROGRAMMABLEPOWER.COM](http://WWW.PROGRAMMABLEPOWER.COM).

## **Date and Revision**

Jun 2013 Revision C

## **Part Number**

M551066-01



## **Contact Information**

Telephone: 800 733 5427 (toll free in North America)  
858 450 0085 (direct)  
Fax: 858 458 0267  
Email: [sales@programmablepower.com](mailto:sales@programmablepower.com)  
[PPSsupport.PPD@ametek.com](mailto:PPSsupport.PPD@ametek.com)  
Web: [www.programmablepower.com](http://www.programmablepower.com)

This page intentionally left blank.

# Important Safety Instructions

Before applying power to the system, verify that your product is configured properly for your particular application.

 <b>WARNING</b>	<b>Hazardous voltages may be present when covers are removed. Qualified personnel must use extreme caution when servicing this equipment. Circuit boards, test points, and output voltages also may be floating above (below) chassis ground.</b>
 <b>WARNING</b>	<b>The equipment used contains ESD sensitive ports. When installing equipment, follow ESD Safety Procedures. Electrostatic discharges might cause damage to the equipment.</b>

Only *qualified personnel* who deal with attendant hazards in power supplies, are allowed to perform installation and servicing.

Ensure that the AC power line ground is connected properly to the Power Rack input connector or chassis. Similarly, other power ground lines including those to application and maintenance equipment *must* be grounded properly for both personnel and equipment safety.

Always ensure that facility AC input power is de-energized prior to connecting or disconnecting any cable.

In normal operation, the operator does not have access to hazardous voltages within the chassis. However, depending on the user's application configuration, **HIGH VOLTAGES HAZARDOUS TO HUMAN SAFETY** may be normally generated on the output terminals. The customer/user must ensure that the output power lines are labeled properly as to the safety hazards and that any inadvertent contact with hazardous voltages is eliminated.

Guard against risks of electrical shock during open cover checks by not touching any portion of the electrical circuits. Even when power is off, capacitors may retain an electrical charge. Use safety glasses during open cover checks to avoid personal injury by any sudden component failure.

Neither AMETEK Programmable Power Inc., San Diego, California, USA, nor any of the subsidiary sales organizations can accept any responsibility for personnel, material or inconsequential injury, loss or damage that results from improper use of the equipment and accessories.

## SAFETY SYMBOLS



**WARNING**  
Risk of Electrical Shock



**CAUTION**  
Refer to Accompanying Documents



Off (Supply)



Direct Current (DC)



Standby (Supply)



Alternating Current (AC)



On (Supply)



Three-Phase Alternating Current



Protective Conductor Terminal



Earth (Ground) Terminal



Fuse



Chassis Ground

This page intentionally left blank.

## Product Family: Photovoltaic Simulator

### Warranty Period: One Year

#### WARRANTY TERMS

AMETEK Programmable Power, Inc. ("AMETEK"), provides this written warranty covering the Product stated above, and if the Buyer discovers and notifies AMETEK in writing of any defect in material or workmanship within the applicable warranty period stated above, then AMETEK may, at its option: repair or replace the Product; or issue a credit note for the defective Product; or provide the Buyer with replacement parts for the Product.

The Buyer will, at its expense, return the defective Product or parts thereof to AMETEK in accordance with the return procedure specified below. AMETEK will, at its expense, deliver the repaired or replaced Product or parts to the Buyer. Any warranty of AMETEK will not apply if the Buyer is in default under the Purchase Order Agreement or where the Product or any part thereof:

- is damaged by misuse, accident, negligence or failure to maintain the same as specified or required by AMETEK;
- is damaged by modifications, alterations or attachments thereto which are not authorized by AMETEK;
- is installed or operated contrary to the instructions of AMETEK;
- is opened, modified or disassembled in any way without AMETEK's consent; or
- is used in combination with items, articles or materials not authorized by AMETEK.

The Buyer may not assert any claim that the Products are not in conformity with any warranty until the Buyer has made all payments to AMETEK provided for in the Purchase Order Agreement.

#### PRODUCT RETURN PROCEDURE

1. Request a Return Material Authorization (RMA) number from the repair facility (**must be done in the country in which it was purchased**):
  - **In the USA**, contact the AMETEK Repair Department prior to the return of the product to AMETEK for repair:  
Telephone: 800-733-5427, ext. 2295 or ext. 2463 (toll free North America)  
858-450-0085, ext. 2295 or ext. 2463 (direct)
  - **Outside the United States**, contact the nearest Authorized Service Center (ASC). A full listing can be found either through your local distributor or our website, [www.programmablepower.com](http://www.programmablepower.com), by clicking Support and going to the Service Centers tab.
2. When requesting an RMA, have the following information ready:
  - Model number
  - Serial number
  - Description of the problem

**NOTE:** Unauthorized returns will not be accepted and will be returned at the shipper's expense.

**NOTE:** A returned product found upon inspection by AMETEK, to be in specification is subject to an evaluation fee and applicable freight charges.

This page intentionally left blank.



# TABLE OF CONTENTS

<b>SECTION 1 PRODUCT OVERVIEW .....</b>	<b>3</b>
1.1 Introduction.....	3
1.2 User Interface.....	3
1.3 Applicable Elgar Part Numbers .....	3
1.4 PV Simulator Block Diagram .....	4
1.5 ETS600X Specifications.....	5
1.6 Mechanical drawings.....	7
<b>SECTION 2 INSTALLATION .....</b>	<b>9</b>
2.1 Unpacking and Inspection .....	9
2.2 Electrical Connections.....	10
2.2.1 AC Input.....	10
2.2.2 DC Output.....	10
2.2.3 Ethernet.....	10
2.2.4 V-SNS Remote Sense .....	10
2.2.5 USB, MS/SL, RS-232, I-SNS/LDC, OPT I/V-SN.....	10
2.2.6 AUX I/O .....	11
2.3 Rear panel switches and indicators.....	12
2.4 Front Panel status indicator .....	12
2.5 System assembly recommendations .....	12
<b>SECTION 3 OPERATION .....</b>	<b>15</b>
3.1 Connecting to a Computer.....	15
3.1.1 Network configuration.....	15
3.1.2 System configuration .....	17
3.2 Inverter testing.....	17
3.2.1 Parallel connections .....	18

3.2.2 Series connections ..... 18

**SECTION 4 COMPUTER MANAGEMENT ..... 19**

4.1 Performing TerraSAS software updates ..... 19  
4.1.1 Step 1: Uninstall TerraSAS ..... 19  
4.1.2 Step 2: Install a new TerraSAS software release ..... 20  
4.2 Performing firmware updates ..... 22  
4.3 Computer configuration ..... 23

**SECTION 5 CALIBRATION ..... 25**

5.1 Required equipment ..... 25  
5.2 Operation ..... 25  
5.3 Calibration interval ..... 25

**LIST OF FIGURES**

Figure 1-1 PV Simulator block diagram ..... 4  
Figure 1-2 Front, side and top views ..... 7  
Figure 1-3 Front panel ..... 8  
Figure 1-4 Rear view ..... 8  
Figure 1-5 Rear I/O panel ..... 8

**LIST OF TABLES**

Table 1 - Maximum input current per phase (Amps) ..... 10  
Table 2 - Maximum output current (Amps) ..... 10

# SECTION 1

## PRODUCT OVERVIEW

### 1.1 INTRODUCTION

The Elgar PV Simulator is a programmable digital power source designed to simulate the electrical behavior of terrestrial photovoltaic arrays. The simulator provides a turn-key hardware and software solution to deliver all the functionality required to test the maximum peak power tracking (MPPT) characteristics of solar inverters and charge controllers. The ability to simulate any fill factor and material technology allows the simulator to characterize the inverter's MPPT algorithm performance quickly and efficiently. It also allows to perform conversion efficiency, thermal analysis and dynamic performance tests by supplying a highly stable and repeatable stimulus to the inverter under test.

### 1.2 USER INTERFACE

The simulator front panel only features an on/off switch and a status indicator. The user interacts with the simulator through a remote Ethernet connection.

A single desktop or laptop computer running TerraSAS software can control up to 48 simulators. Due to the high transmission speed and data integrity provided by the Ethernet architecture, operating parameters are displayed in real time on the computer screen at refresh rates comparable to standard instrumentation.

The software allows modeling a PV panel from data normally found in the manufacturer data sheet. These parameters are  $V_{oc}$  (open circuit voltage),  $I_{sc}$  (short circuit current),  $V_{mp}$  (voltage at the maximum power point),  $I_{mp}$  (current at the maximum power point),  $\beta_v$  (voltage temperature coefficient) and  $\beta_p$  (power temperature coefficient).

In addition to static tests, the software allows to execute irradiance/temperature profiles that can closely duplicate real life conditions or predefined test sequences.

### 1.3 APPLICABLE ELGAR PART NUMBERS

ETS600X8C-PVF	5kW, 208VAC	ETS600X25C-PVF	15kW, 208VAC
ETS600X8D-PVF	5kW, 400VAC	ETS600X25D-PVF	15kW, 400VAC
ETS600X8E-PVF	5kW, 480VAC	ETS600X25E-PVF	15kW, 480VAC
ETS600X17C-PVF	10kW, 208VAC		
ETS600X17D-PVF	10kW, 400VAC		
ETS600X17E-PVF	10kW, 480VAC		

## 1.4 PV SIMULATOR BLOCK DIAGRAM

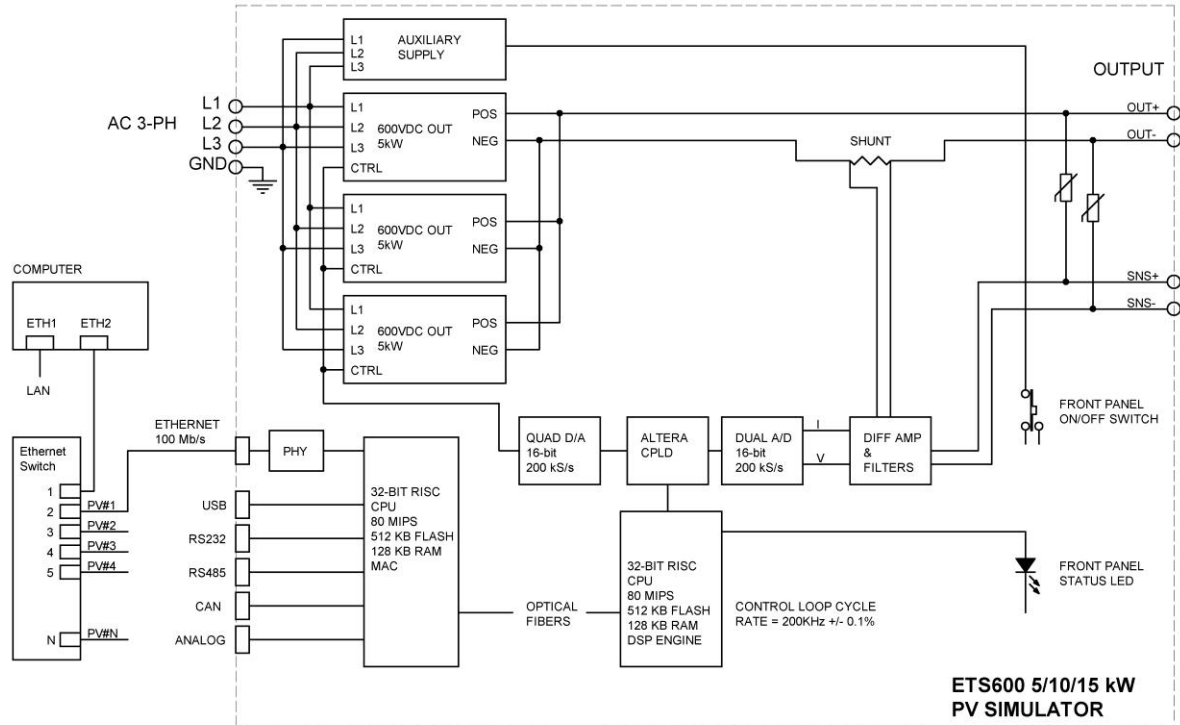

**Figure 1-1 PV Simulator block diagram**

At the heart of the PV simulator are two 80 MIPS RISC microcontrollers.

One processor interfaces with a 16-bit measurement and control system that monitors the source output voltage and current at 5  $\mu$ s intervals.

At each interval, the processor sends computed data to its 16-bit D/A control system that adjusts the current source setpoint to follow the programmed IV curve.

The other processor supports the Ethernet interface, analog and digital I/O.

While in static simulation mode, the simulator executes a single IV curve.

In the PV Simulator memory, an IV curve is represented by 1,024 data pairs or points. Each pair of values represents a single voltage / current point on the IV curve.

The PV simulator interpolates the 1,024 points in its curve memory with 16-bit accuracy, delivering an actual curve resolution of 65,536 points.

When irradiance / temperature profiles are executed, dynamically updated IV curves are downloaded at fixed 1-second intervals. The PV simulator linearly interpolates between consecutive curves 128 times per second (7.8 ms intervals), delivering smooth voltage and current waveforms to the unit under test.

## 1.5 ETS600X SPECIFICATIONS

<u>DC Output</u>	Open Circuit Voltage, Voc: 1 – 600 VDC Short Circuit Current, Isc: 0 – 8.3A per chassis (5kW) 0 – 16.7A per chassis (10kW) 0 – 25A per chassis (15kW)  Maximum output power at fill factor 0.85 4.25 kW (5kW) 8.5 kW (10kW) 12.75 kW (15kW)
<u>Output isolation</u>	±600 Vpk, positive or negative output to chassis ground, continuous
<u>Output leakage</u>	Output to chassis ground, DC : < 0.1 mA @ 500Vdc Output to chassis ground, AC : < 5 mA @ 200Vpp, 60Hz (5kW) < 7 mA @ 200Vpp, 60Hz (10kW) < 10 mA @ 200Vpp, 60Hz (15kW)
<u>Tracking speed</u>	Compatible with inverters sweeping the MPP at up to 200 Hz.
<u>Accuracy</u>	Voltage programming and readback: ±0.2% of full scale voltage Current programming and readback: ±0.5% of full scale current
<u>Sampling resolution</u>	Voltage and current are synchronously sampled by two independent 16-bit A/D converters at 200kS/s.
<u>Curve Resolution</u>	1,024 points. Each point represents a single voltage / current point on the IV curve. The PV simulator interpolates the 1,024 points in its curve memory with 16-bit resolution, delivering an actual curve resolution of 65,536 points.
<u>Profiles resolution</u>	There is no limit to the profile length. One-second profiles for a full day of simulation are typically 50k points. The simulator interpolates between points 128 times per second, delivering smooth voltage and current waveforms that closely resemble real solar arrays under cloudy conditions (requires TerraSAS software)
<u>Curve equations</u>	Equations used to calculate and translate the IV curves are found in Appendix A1 and A2 of the publication “Performance test Protocol for Evaluating Inverters Used in Grid-Connected Photovoltaic System”, October 2004, Sandia National Labs.
<u>PV Array Parameters</u>	Irradiance level: 0 to 1999 W/m <sup>2</sup> Temperature value: -100°C to +100°C Voltage level: 0 to 600VDC Current level: 0 to 25A (15kW) Voltage and power temperature coefficients: ±1.99%/°C
<u>Expansion</u>	Unrestricted expandability, allowing total system power above 1MW
<u>Available I/O</u>	<b>Ethernet 10/100 Mb/s:</b> TerraSAS software proprietary high-speed link. <b>Analog Irradiance/Temperature inputs:</b> allow to adjust the IV curve in real time based on two external analog signals. <b>Trigger input:</b> allows to start executing an irradiance/temperature profile in sync with external equipment. Useful for accurate energy measurements using external power analyzers. <b>SCPI interface:</b> through TerraSAS software
<u>Remote sense</u>	Maximum line drop 10V per line

<u>Input Nominal Voltage</u>	3 phase, 3 wire + ground 208/220 VAC (operating range 187 - 242 VAC) 380/400 VAC (operating range 342 - 440 VAC) 440/480 VAC (operating range 396 - 528 VAC)
<u>Input Frequency</u>	47 – 63 Hz
<u>Power Factor</u>	>0.9 typical
<u>Protection (typical)</u>	½ cycle ride-through on all three phase 3 cycle ride through on single phase; missing phase shutdown
<u>OVP Accuracy</u>	0.2% of full scale voltage
<u>OVP Resolution</u>	0.002% of full scale voltage
<u>Output noise</u>	< 2 Vpp measured across a 1µF capacitor at the end of a 1.8m (6ft) line at full load.
<u>Current noise</u>	< 200 mA <sub>p-p</sub> at maximum output current, 650kHz bandwidth < 50 mA <sub>rms</sub> at maximum output current, 650kHz bandwidth
<u>Efficiency</u>	87% typical at nominal line and max load
<u>Stability</u>	±0.05% of set point after 30 minute warm-up and over 8 hours at fixed line, load and temperature, typical
<u>Temperature Coefficient</u>	0.02%/ °C of maximum output voltage rating for voltage set point, typical 0.03%/ °C of maximum output current rating for current set point, typical
<u>Operating Temperature</u>	0 to 50° C
<u>Storage Temperature</u>	-25° C to 65° C
<u>Humidity Range</u>	Relative humidity up to 95% non-condensing, 0° C – 50° C
<u>Altitude</u>	Operating full power available up to 5,000 ft. (~1,500 m), derate 10% of full power for every 1,000 feet higher; non-operating to 40,000 ft. (~12,000 m)
<u>Cooling</u>	Front and side air inlet, rear exhaust. Temperature controlled variable speed fans. Units may be stacked without spacing.
<u>Regulatory</u>	Certified to UL/CSA 61010 and IEC/EN 61010-1 by a NRTL, CE Compliant, Semi-F47 Compliant. LVD Categories: Installation Category II: Pollution Degree 2; Class II Equipment: for Indoor Use Only.
<u>EMC Directive</u>	EN 61326:1998
<u>Accessories</u>	K550212-01: 3U Rack Slides 5550568-01: Front panel dust filter - field installation kit
<u>Physical</u>	Width 19.00 in (48.3 cm) Depth 25.46 in (64.7 cm) Height 5.25 in (13.3 cm) Weight 40 lbs (18 kg) (5kW) 60 lbs (27 kg) (10kW) 80 lbs (36 kg) (15kW)

# 1.6 MECHANICAL DRAWINGS

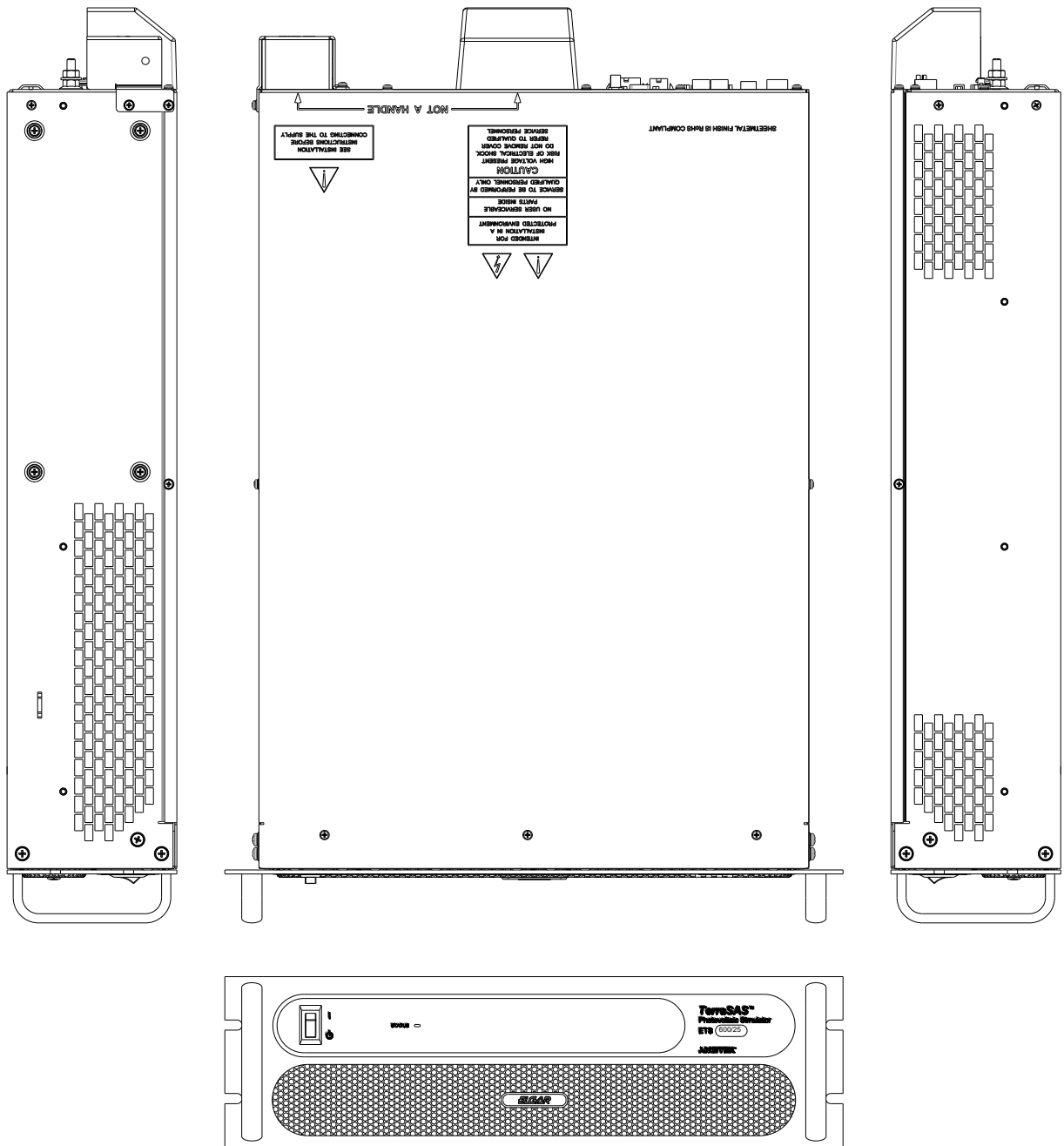

Figure 1-2 Front, side and top views

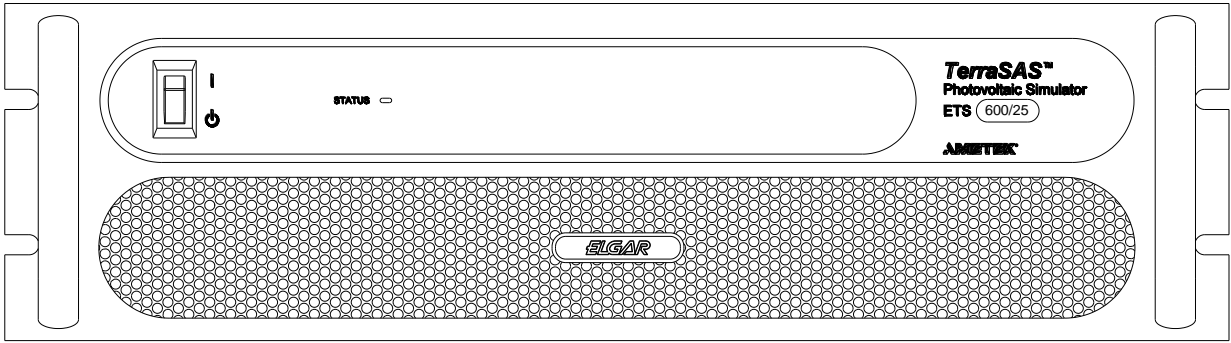

Figure 1-3 Front panel

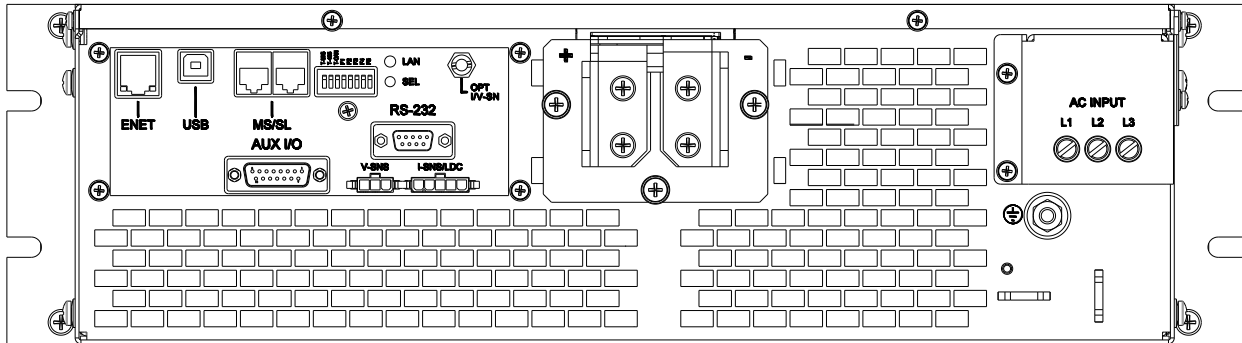

Figure 1-4 Rear view

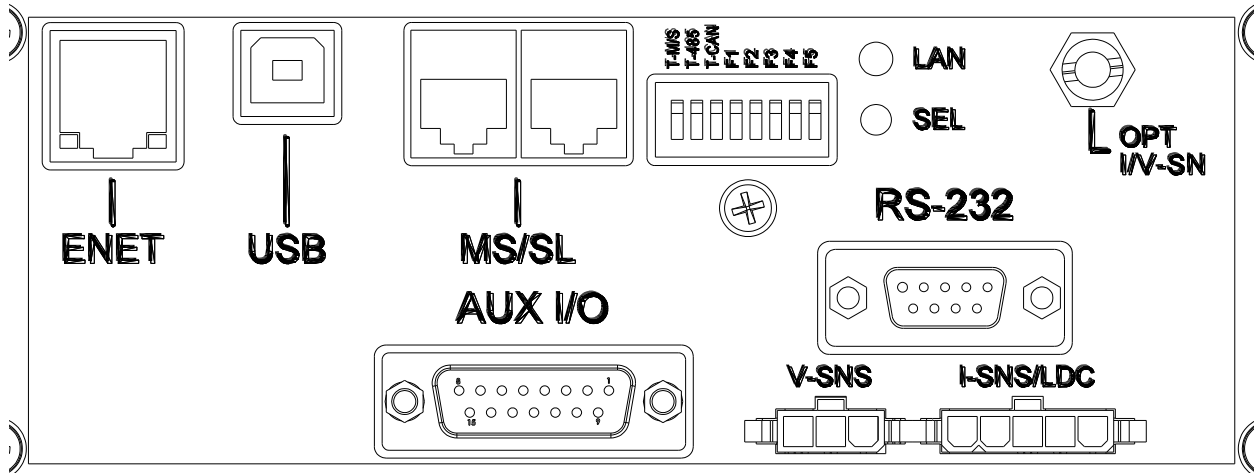

Figure 1-5 Rear I/O panel



# SECTION 2 INSTALLATION

## 2.1 UNPACKING AND INSPECTION

After unpacking the unit, inspect the contents for any obvious physical damage. If damage has occurred, contact the shipper of the hardware. If replacement parts are required, contact Ametek Customer Service at 1-800-733-5427, ext. 2295 or 858-450-0085, ext. 2295.

The following items should be included:

ELGAR P/N	DESCRIPTION	QTY
856-390-03	REMOTE SENSE MATING CONNECTOR, 3 POLES	1
856-390-00	CRIMP CONTACTS FOR ABOVE	4
856-DA1-5P	AUX I/O MATING CONNECTOR, 15 PINS	1
856-247-15	BACKSHELL (HOOD) FOR ABOVE	1
110-032-01	SCREW, 10-32 X .500, BLACK 27038	4
9550389-01	DC OUTPUT BUSBAR PROTECTIVE COVER	1
4-675	LUG, #3/8, 10-12AWG RING, INSULATED	2
107-240-17	LUG, #5/16, 12-10AWG, RING, NYL	1
110LJ10-16	SCREW, 3/8-16 X 1.00, HEX, BRASS	2
112LB10-01	NUT, 3/8-16, HEX, BRASS	2
111LA10-01	WASHER, 3/8, FLAT, BRASS	4
111LC10-01	WASHER, 3/8, SPLIT LOCK, BRASS	2
M551066-01	PRINTED COPY OF THIS USER MANUAL	1
5609155-XX	TERRASAS SOFTWARE INSTALLATION DISK	1

## 2.2 ELECTRICAL CONNECTIONS

### 2.2.1 AC Input

See figure 1-4 to locate the AC input terminal block and ground stud. The wire gauge should be sized according to the table below.

**Table 1 - Maximum input current per phase (Amps)**

	5 kW	10 kW	15 kW
208 VAC	19.8	39.5	59.2
400 VAC	10.8	21.6	32.4
480 VAC	9.4	18.7	28.0

### 2.2.2 DC Output

See figure 1-4 to locate the output busbars. Use the 3/8" ring lugs and hardware provided with the unit to make a reliable connection. The wire gauge should be sized according to the table below.

**Table 2 - Maximum output current (Amps)**

5 kW	10 kW	15 kW
8.33	16.7	25

### 2.2.3 Ethernet

Use standard CAT5e or CAT6 Ethernet patch cords.

### 2.2.4 V-SNS Remote Sense

Remote sense lines should be connected as close as possible to the input terminals of the inverter under test, to maximize measurement accuracy. Use the mating connector and contacts provided with the unit. Connections are as follows:

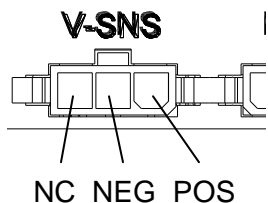

### 2.2.5 USB, MS/SL, RS-232, I-SNS/LDC, OPT I/V-SN

These high speed digital, analog and optical interfaces are not supported in the current firmware release and are intended for future use.

## 2.2.6 AUX I/O

This is a standard 15-pin female D-SUB connector. The mating connector is provided with the unit. Electrical signals are listed below:

AUX I/O CONNECTIONS				
MATING CONNECTOR TYPE: D-SUB 15 PIN MALE				
PIN #	DESCRIPTION	VOLTAGE	CURRENT	COMMENTS
1	CAN BUS H	CAN standard		Not supported by current firmware revision.
2	CAN BUS L			
3	RS-485 D+	RS-485 standard		Not supported by current firmware revision.
4	RS-485 D-			
5	IRRADIANCE INPUT	0 to 2.5V	<10 $\mu$ A	0 to 1999 W/m <sup>2</sup> (1)
6	TEMPERATURE INPUT	0 to 2.5V	<10 $\mu$ A	-100°C to 100°C (1)
7	INTERLOCK +	24V $\pm$ 20%	<3 mA	Output turns off if interlock signal is not present, unless interlock override is active (DIP switch F3). (2)
8	INTERLOCK -			
9	FAULT OUTPUT +	30V max	1A max	Not supported by current firmware revision.
10	FAULT OUTPUT -			
11	CAL RELAY +	30V max	1A max	Used by calibration fixture and software.
12	CAL RELAY -			
13	TRIGGER INPUT	0 to 5V	< 2mA	Active low. (3)
14	REFERENCE VOLTAGE	2.5V	5 mA max	Precision voltage reference
15	SIGNALS GROUND			Analog and digital return
BODY	CHASSIS GROUND			Connect to cable shield

### NOTES:

- 1) See software user manual for details about monitoring these signals or allowing them to control an IV curve in real time.
- 2) The interlock input is isolated from ground and can tolerate up to  $\pm$ 100V from each input to chassis ground. This input is handled by the microcontrollers and is therefore not intended for safety-critical applications. Electromechanical relays or circuit breakers that remove the AC input to the simulator are required to meet safety regulations when failure to operate could harm human operators or otherwise represent a safety hazard.
- 3) This input accepts standard TTL/CMOS logic levels. It also accepts an isolated relay contact due to the internal pull-up resistor to +5V. When active, this signal starts executing a profile. See software user manual for details about loading and executing irradiance/temperature profiles.



## 2.3 REAR PANEL SWITCHES AND INDICATORS

8-POSITION SWITCH (see figure 1-5)		
SWITCH	DEFAULT POSITION	FUNCTION
T-M/S	OFF	Master / Slave line termination (120 Ω)
T-485	OFF	RS-485 line termination (120 Ω)
T-CAN	OFF	CAN line termination (120 Ω)
F1	OFF	Not used
F2	OFF	Not used
F3	OFF	Interlock input override (desktop mode)
F4	OFF	Not used
F5	OFF	Firmware update mode

LAN FEATURES (see figure 1-5)		
ITEM	TYPE	FUNCTION
LAN	INDICATOR	LAN status
SEL	PUSHBUTTON	Select (used during system configuration)

## 2.4 FRONT PANEL STATUS INDICATOR

The front panel STATUS indicator (blue LED) visually reports one of five possible operating conditions. Blinking patterns are repeated every 2 seconds.

FRONT PANEL STATUS INDICATOR		
LIGHT PATTERN	STATUS	DESCRIPTION
Steady OFF	OFF	The simulator is turned off (front panel power switch off or no power)
Long pulse	IDLE	The simulator is turned on but not communicating with the system controller (PC). Output power is automatically turned off.
Steady ON	ON	The simulator is turned on and communicating with the system controller (PC).
One short pulse	OVP	Overvoltage protection tripped. Reduce the output voltage; turn the output off, then on to clear (see TerraSAS software manual)
Two short pulses	FAULT	Power module overheat or fault. Turn the front panel power switch off, then on to clear. Contact the factory if this condition becomes permanent and cannot be cleared.

## 2.5 SYSTEM ASSEMBLY RECOMMENDATIONS

- ❖ Elgar PV simulators are heavy. When assembling multi-channel systems into standard 19" racks, select rugged steel cabinets intended for industrial

applications. Aluminum cabinets designed for light instrumentation will not likely meet the requirement.

- ❖ Use rack slides (Elgar p/n K550212-01) or heavy-gauge steel brackets to properly support the weight of the simulators.
- ❖ On rack systems, ensure adequate ventilation is provided to avoid excessive temperatures. Elevated temperatures reduce the life of the unit and can cause over-temperature protections to trip.
- ❖ High power inverters produce strong EMI fields, both radiated and conducted. Do not use computer keyboards with touch-pads as this technology is very sensitive to RF fields and will likely malfunction. Optical trackballs or mice provide the best results. Optical isolation on USB keyboards is recommended to avoid frequent lock-ups and erratic operation. Suitable USB isolators can be purchased from Ametek (isolator p/n 881-004-06 and short A-B cable p/n 890-504-03). USB isolators need to support the USB 1.1 low speed protocol (1.5 Mbits/s) in order to work properly with most keyboards.
- ❖ Keep data and control lines wiring as far as possible from AC and DC power and sense lines.
- ❖ Use wire, terminal blocks and connectors rated for 600V operation on all output and sense wiring.

This page intentionally left blank.

# SECTION 3 OPERATION

## 3.1 CONNECTING TO A COMPUTER

The TerraSAS software can control one or more PV simulators over a single Ethernet link. The CD that comes with the unit contains the installation files and the software user manual in Adobe PDF format. Detailed installation instructions are included in the manual. After installing the software, follow the instructions below to establish communication with one or more PV simulators.

### 3.1.1 Network configuration

The easiest way to connect to a single PV simulator is outlined below:

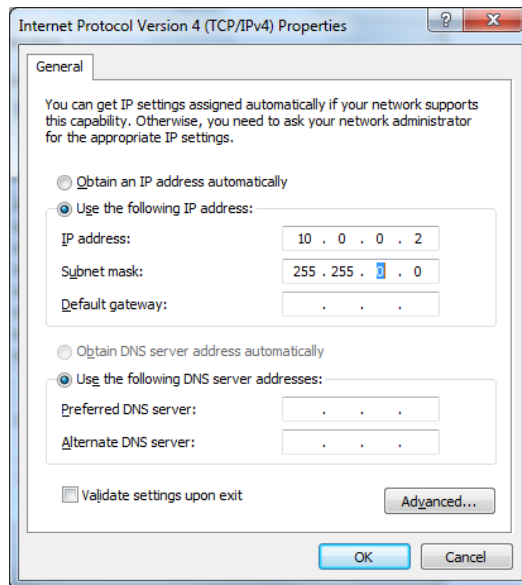
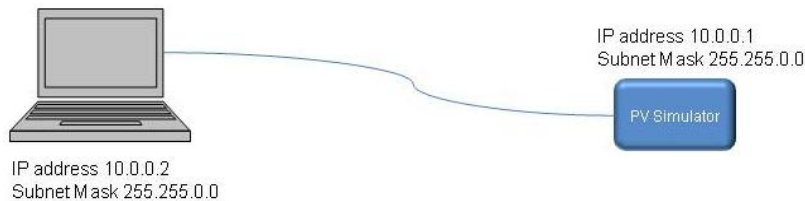

Simply access the Ethernet adapter Properties page and set as indicated.

With this topology, a static IP address is manually assigned to the computer.

When the PV simulator is turned on, it defaults to IP address 10.0.0.1 and communication is immediately established.

**This method cannot be used to control two or more simulators.**

When controlling more than one PV simulator, an Ethernet switch is required:

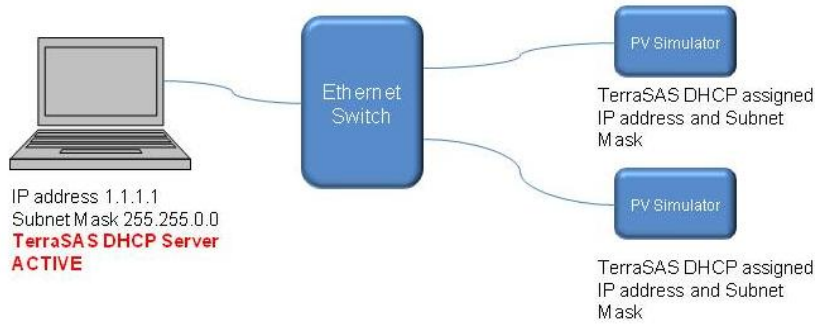

When setting the computer's IP address to 1.1.1.1, the TerraSAS DHCP server is automatically enabled. In this topology, always make sure that the computer is turned on and a user is logged in before turning on the PV simulators. Within a few seconds, all PV simulators are assigned an IP address. When this happens, the LAN LED on the rear panel (see figure 1-5) starts blinking faster. This confirms that the Ethernet network is active and working properly.

If not, the computer has a **firewall** installed. Refer to the firewall documentation to unblock the program dhcpsrv.exe, located in C:\TerraSas Configuration.

If desired, the Ethernet switch can be connected to the Local Area Network:

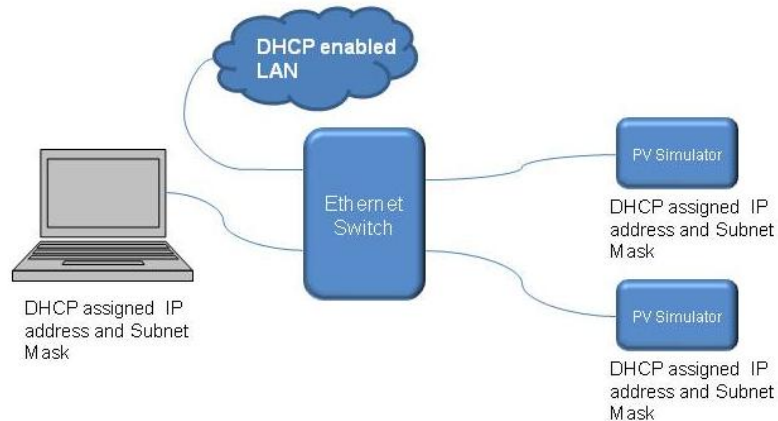

In this topology, the Ethernet adapter must be configured for DHCP (“Obtain an IP address automatically” and “Obtain DNS server address automatically”, see screenshot on previous page.)

The advantage of this method is that PV simulators and computers can be located anywhere on the LAN, as long as they share the same subnet.

The disadvantage is that PV simulators are accessible to any computer on the LAN, which could lead to unauthorized access and safety hazards.



Never set the computer IP address to 1.1.1.1 in this topology, as the TerraSAS DHCP server will interfere with the LAN's DHCP server and cause serious service disruptions.



When it is desirable to control the TerraSAS computer from a remote location, a computer featuring two Ethernet adapters is recommended:

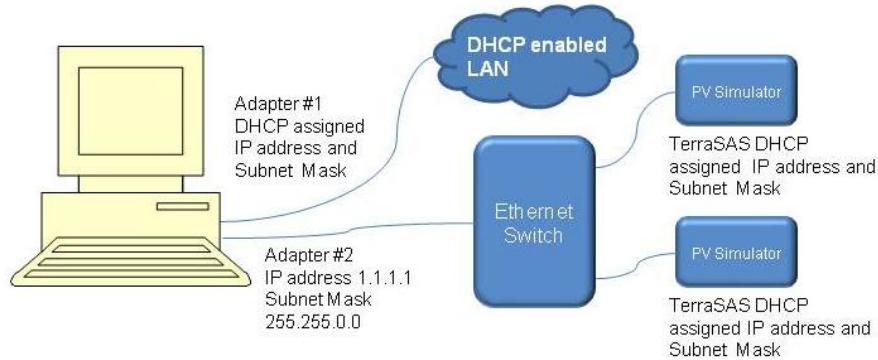

See the software user manual for software configuration details and one-time DHCP server startup procedures.

### 3.1.2 System configuration

Once the desired network has been wired and configured, launch TerraSAS. The software will inform that a system configuration table needs to be created and automatically opens the appropriate form. The purpose of the configuration table is to establish which PV simulators are to be controlled and what channel number should be assigned to each one. Once the system configuration table has been created and stored, TerraSAS will only communicate with the specified simulators, in the order that has been selected. Up to four configuration tables can be stored and retrieved, allowing additional flexibility. Detailed system configuration instructions are described in the software user manual and are also shown on the configuration form that opens in the software.

## 3.2 INVERTER TESTING

Carefully read the installation manual of the solar inverter or battery charger before connecting it to the PV simulator.

In particular, make sure the maximum Voc is never exceeded to avoid damaging the device under test.



It is strongly recommended to set the overvoltage protection at or below the maximum operating voltage to protect the inverter.

The ETS600X simulator has isolated DC outputs and supports negative and positive PV array grounding schemes. Its low output leakage allows testing non-isolated (transformer-less) type inverters.

Always connect the sense lines as close as possible to the inverter under test to maximize measurement accuracy.

### 3.2.1 Parallel connections

The outputs of two or more ETS600X simulators can be paralleled to increase the available output current. All sense lines must be connected and terminated as close as possible to the inverter under test to achieve the best possible measurement accuracy.

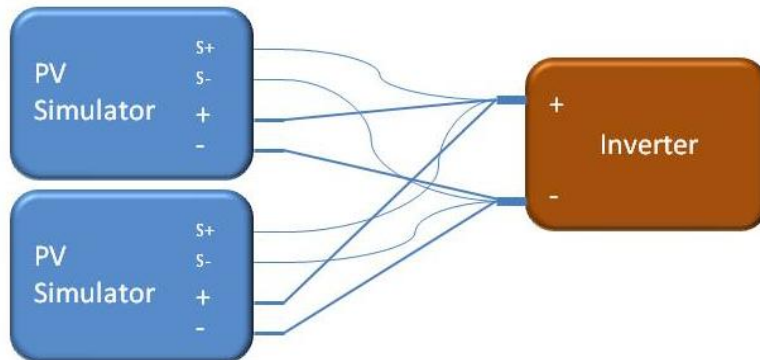

### 3.2.2 Series connections

Two ETS600X simulators can be connected in series to achieve 1,200V operation. See electrical connections below.

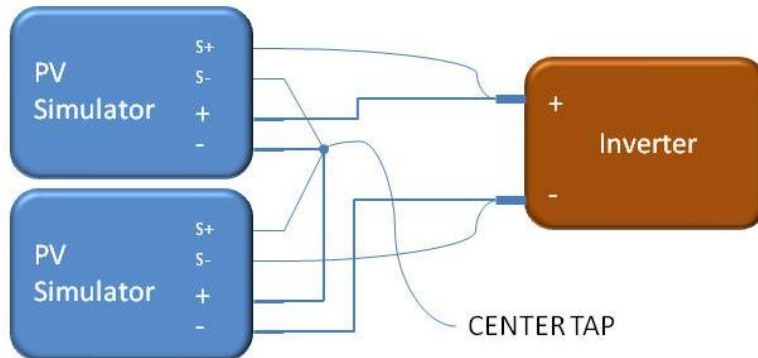

Since the maximum voltage-to-ground on any sense or output terminal is  $\pm 600V$ , connect the center tap as follows:

- ❖ For isolated inverters, connect the center tap to ground.
- ❖ For non-isolated inverters (also called transformer-less) leave the center tap floating (not connected).



If the maximum voltage-to-ground is exceeded, one or both PV simulators could be permanently damaged.

Sense lines carry little current and AWG20 wires rated for 600V operation are recommended.

Once the electrical connections are made, select **System > Channels grouping setup** to configure the software for the desired wiring. See the software user manual for additional details.

# SECTION 4 COMPUTER MANAGEMENT

## 4.1 PERFORMING TERRASAS SOFTWARE UPDATES

### 4.1.1 Step 1: Uninstall TerraSAS

Click on the Windows 7 logo and select Control Panel:

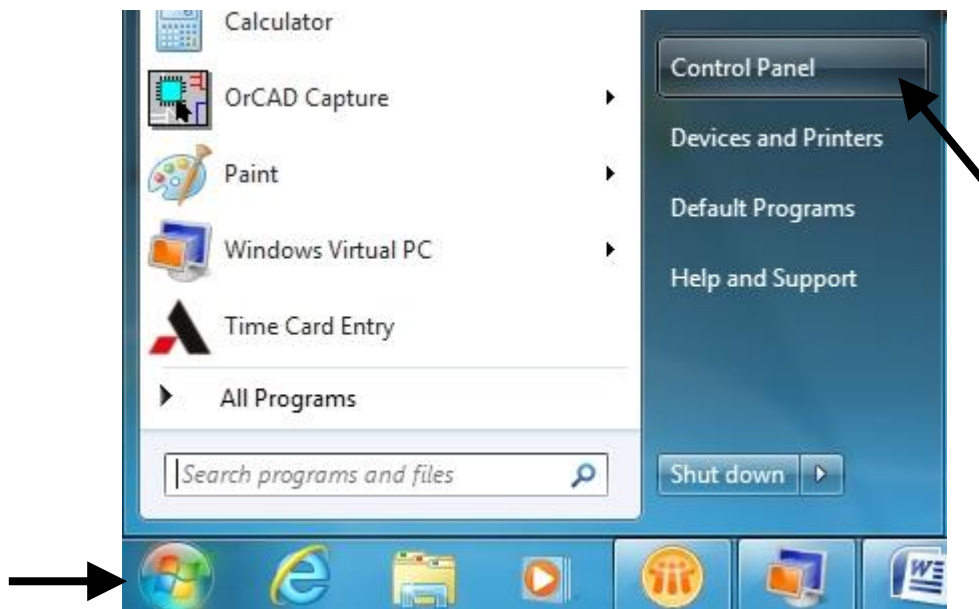

Click on Uninstall a program



Right click on TerraSAS and click Uninstall/Change

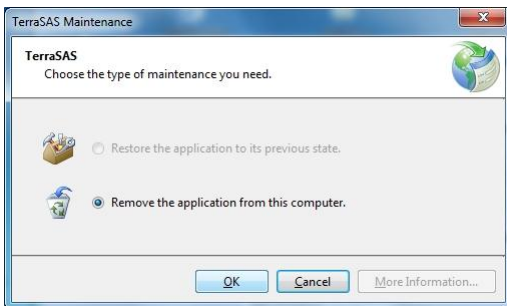
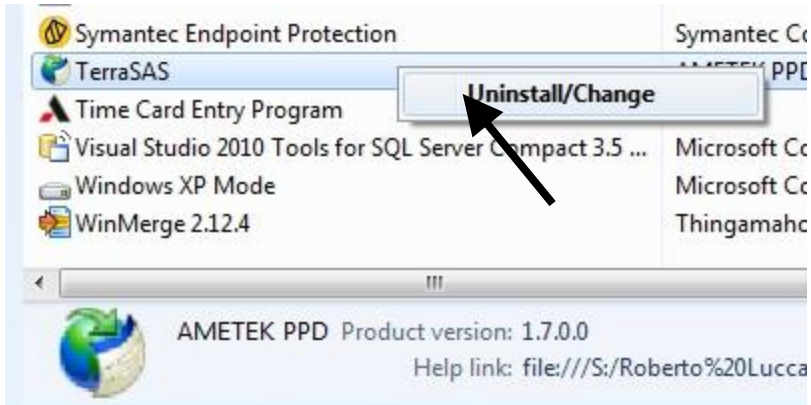

Click OK to remove TerraSAS. This only removes the software. System configuration, curves, profiles, data log and any other user files are not affected.

#### 4.1.2 Step 2: Install a new TerraSAS software release

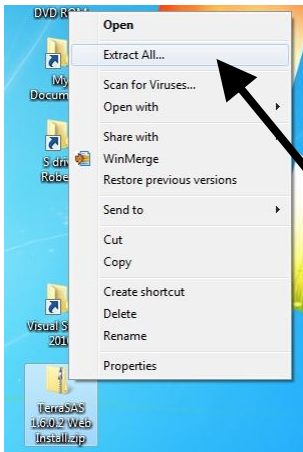

A new TerraSAS install set is usually e-mailed as a download link through Ametek's file transfer service Amefex. The file size is less than 10 Mbytes.

Download the file to your desktop, then right click on it and select **Extract All**.

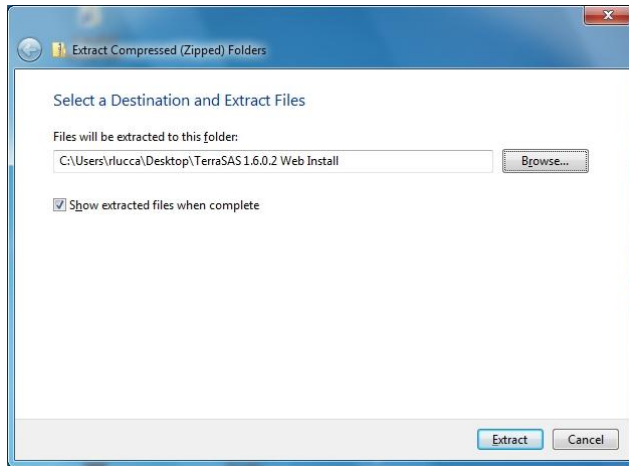

Click **Browse...**

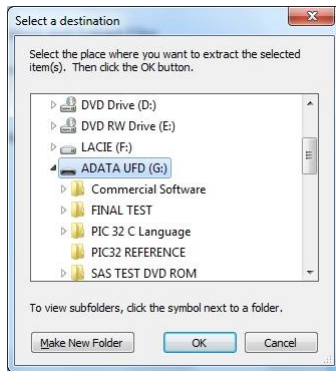

Insert a USB drive and navigate to it. Click **OK** and then click **Extract** on the previous dialog to store the install set on the USB drive.

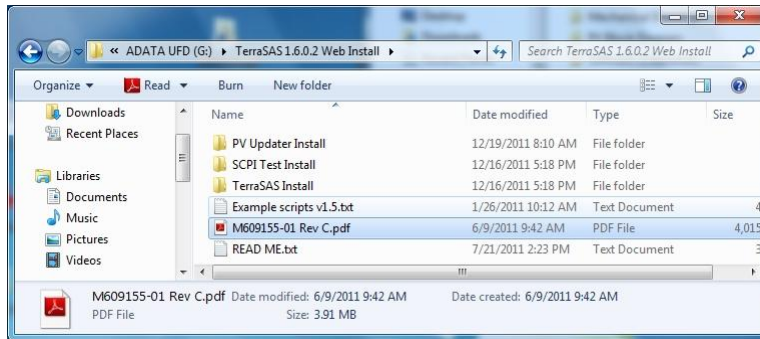

Insert the USB drive into any available USB port on the computer running TerraSAS.

Navigate to the TerraSAS x.x.x.x Web Install folder. Open the READ ME file and, if instructed to do so, execute section 4.3 to update the PV simulator firmware.

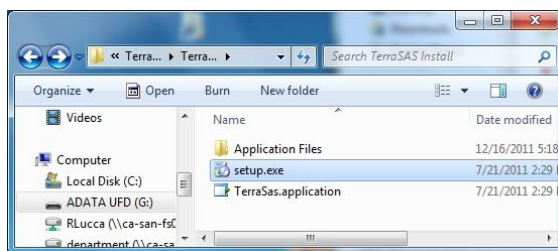

Open the folder named **TerraSAS Install** and double click on the **setup.exe** file.



Follow the instructions and then accept the security warning by clicking on the **Install** button.

The updated TerraSAS software will launch as soon as the above dialog will complete.

To complete the process, copy the updated software user manual (M609155-01 Rev X.pdf) and Example scripts vX.X to your **My Documents** folder.

## 4.2 PERFORMING FIRMWARE UPDATES

This procedure updates the computer code running on the two embedded processors within the PV simulator:

- Refer to the screenshots in section 4.1.2 to download and install the **PV Updater** software on the TerraSAS control computer. If a previous version of the PV Updater is present, refer to the screenshots in section 4.1.1 to remove it. **All PV simulators connected to the computer will be updated.**
- Turn off all PV simulators. Locate the 8-position switch on the rear side of the PV simulators (see figure 1-5)
- On all PV simulators, slide the F5 switch to the ON position
- Turn on all PV simulators. Note that the front panel **STATUS** LED does not blink as usual, as PV simulators entered firmware update mode. Wait 10 seconds to allow all simulators to acquire an IP address.

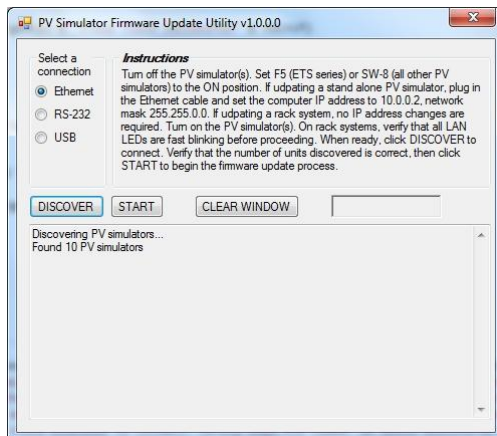

Double click on the PV updater icon to start the firmware update utility.

Click on the **DISCOVER** button to connect.

Verify that all PV simulators are detected

Click on the **START** button to begin.



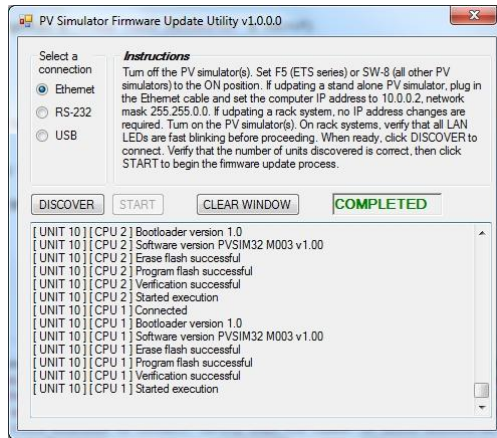

The process takes about one minute for each simulator, during which activity details are displayed. When all PV simulators are successfully updated, a green **COMPLETED** sign is shown.

If any step fails on one or more units, a red **FAILED** sign is displayed. In this case, scroll the activity window to locate which unit failed to update and then contact the factory for assistance.

- Turn off all PV simulators.
- On all PV simulators, slide the F5 switch back to the OFF position
- Turn on all PV simulators.
- Confirm the STATUS LED blinks as usual on all PV simulator front panels.
- Continue to section 4.1.2 to update the TerraSAS software and complete the process.

Note: the firmware update process can be repeated as many times as desired in the unlikely case that something goes wrong. However, after one or two failed attempts, it is strongly suggested to contact the factory for assistance.

**IMPORTANT:** avoid shutting down power, turning off the computer or the PV simulators while a firmware update is in progress. While these events have been extensively tested and caused no harm during software verification, it is advisable to refrain from intentionally causing them.

### 4.3 COMPUTER CONFIGURATION

The computer controlling one or more PV simulators should be configured with an “Always ON” power scheme. Features designed to conserve power should be disabled, in particular the computer should never hibernate, turn off the screen, reduce CPU speed or turn off the hard drive. All Elgar PV simulators turn off their outputs when the PC stops communicating for more than 50 ms. This is a safety feature designed to avoid loss of control.

This page intentionally left blank.



# **SECTION 5 CALIBRATION**

## **5.1 REQUIRED EQUIPMENT**

The Elgar PV simulator supports fully automated calibration, which requires the following equipment, software and associated documentation:

- Agilent model 34401A or Keithley 2000 Digital Multimeter
- TerraSAS Calibration Suitcase, Elgar p/n 5609175-25
- TerraSAS Calibration software v2.0.0.2 or above, Elgar p/n 5609174-XX
- TerraSAS Calibration User Manual, Elgar p/n M609174-01

## **5.2 OPERATION**

The calibration suitcase has an internal, calibrated precision shunt. It connects to the simulator output, the digital multimeter and the AUX I/O connector on the rear panel.

All cables and accessories are included in the suitcase.

After installing and running the software, the user is guided through a simple procedure, which takes about five minutes to complete.

## **5.3 CALIBRATION INTERVAL**

The recommended calibration interval for all Elgar PV Simulators is one year.