

Sorensen
Mi-BEAM
Series

Programming Manual

This page intentionally left blank

About AMETEK

AMETEK Programmable Power, Inc., a unit of AMETEK Electronic Instruments Group (a division of AMETEK, Inc.), is a global leader in the design and manufacture of precision, programmable power supplies for R&D, test and measurement, process control, power bus simulation and power conditioning applications across diverse industrial segments. Offering bench-top supplies to rack-mounted industrial power subsystems, AMETEK Programmable Power is the proud manufacturer of Elgar, Sorensen, California Instruments, and Amrel brand power supplies and electronic loads.

AMETEK, Inc. is a leading global manufacturer of electronic instruments and electromechanical devices with annualized sales of \$6.9 billion. The company has over 21,000 colleagues working at more than 150 manufacturing facilities and nearly 150 sales and service centers in the United States and 30 other countries around the world.

Trademarks

AMETEK is a registered trademark of AMETEK, Inc. Sorensen is a trademark owned by AMETEK, Inc. Other trademarks, registered trademarks, and product names are the property of their respective owners and are used herein for identification purposes only.

Notice of Copyright

Mi-BEAM Series Programming Manual © 2025, AMETEK Programmable Power, Inc.,
All rights reserved.

Exclusion for Documentation

UNLESS SPECIFICALLY AGREED TO IN WRITING, AMETEK PROGRAMMABLE POWER, INC. ("AMETEK")

(a) MAKES NO WARRANTY AS TO THE ACCURACY, SUFFICIENCY OR SUITABILITY OF ANY TECHNICAL OR OTHER INFORMATION PROVIDED IN ITS MANUALS OR OTHER DOCUMENTATION.

(b) ASSUMES NO RESPONSIBILITY OR LIABILITY FOR LOSSES, DAMAGES, COSTS OR EXPENSES, WHETHER SPECIAL, DIRECT, INDIRECT, CONSEQUENTIAL OR INCIDENTAL, WHICH MIGHT ARISE OUT OF THE USE OF SUCH INFORMATION. THE USE OF ANY SUCH INFORMATION WILL BE ENTIRELY AT THE USER'S RISK.

(c) IF THIS MANUAL IS IN ANY LANGUAGE OTHER THAN ENGLISH, ALTHOUGH STEPS HAVE BEEN TAKEN TO MAINTAIN THE ACCURACY OF THE TRANSLATION, THE ACCURACY CANNOT BE GUARANTEED. APPROVED AMETEK CONTENT IS CONTAINED WITH THE ENGLISH LANGUAGE VERSION, WHICH IS POSTED AT WWW.PROGRAMMABLEPOWER.COM.

Date and Revision

June 2025, Revision A

Document Part Number

M587352-01

Contact Information

Telephone: 800 733 5427 (toll free in North America)
858 450 0085 (direct)
Fax: 858 458 0267
Email: sales.ppd@ametek.com
service.ppd@ametek.com
Web: www.programmablepower.com

Product Family: Mi-BEAM Series Power Supply**Warranty Period: 5 Years****Warranty Terms**

AMETEK provides the following warranty for the product listed above ("Product"): If a defect in materials or workmanship is discovered and reported in writing within the applicable warranty period, AMETEK, at its discretion, will:

1. Repair or replace the defective Product,
2. Issue a credit note for the defective Product, or
3. Provide replacement parts for the defective Product.

The Buyer is responsible for returning the defective Product or parts to AMETEK at their own expense, following the specified return procedure. AMETEK will cover the costs of delivering the repaired or replaced Product or parts back to the Buyer.

4. The Product is damaged due to misuse, accident, negligence, or failure to maintain it as required by AMETEK's specifications.
5. The Product is modified, altered, or combined with unauthorized attachments.
6. The Product is installed or operated contrary to AMETEK's instructions.
7. The Product is opened, modified, or disassembled without AMETEK's prior written consent.
8. The Product is used with items, articles, or materials not authorized by AMETEK.

The Buyer may not make any warranty-related claims unless all payments under the Purchase Order Agreement have been completed.

Product Return Procedure



- Request a Return Material Authorization (RMA) number from the repair facility (**must originate in the country in which it where it was purchased**):
- **In the USA**, contact the AMETEK Customer Service Department prior to the return of the product to AMETEK for repair:
- Telephone: 800-733-5427, ext. 2295 or ext. 2463 (toll free North America) 858-450-0085, ext. 2295 or ext. 2463 (direct).
- **Outside the United States**, contact the nearest Authorized Service Center (ASC). A full listing can be found either through your local distributor, or on our website, www.programmablepower.com, by tapping the Support button or going to the Service Centers tab.
- When requesting an RMA, have the following information ready:
Model number
Serial number
Description of the problem

NOTE: Unauthorized returns will not be accepted and will be returned at the shipper's expense.

NOTE: A returned product found upon inspection by AMETEK to be in the specification is subject to an evaluation fee and applicable freight charges.

IMPORTANT SAFETY INSTRUCTIONS

Before applying power to the system, verify that your product is configured properly for your application.

	<p>WARNING!</p> <p>Hazardous voltages might be present when covers are removed. Qualified personnel must use extreme caution when servicing this equipment. Circuitry, test points, and output voltages might be floating with respect to chassis ground. Do not touch electrical circuits and use appropriately rated test equipment. A safety ground wire must be connected from the chassis to the Alternating current (AC) mains input when servicing this equipment.</p>
	<p>CAUTION!</p> <p>This equipment contains Electrostatic discharge (ESD) sensitive input or output connection ports. When installing equipment, follow ESD safety procedures. ESD might cause damage to the equipment.</p>

Only qualified personnel, who deal with attendant hazards in power supplies, are allowed to perform installation and servicing.

Ensure that the AC input power line ground is connected properly to the unit safety ground chassis. Similarly, other AC power ground lines, including those for application and maintenance equipment, must be grounded properly for both personnel safety and equipment protection.

Always ensure that facility AC input power is de-energized prior to connecting or disconnecting any cable.

In normal operation, the operator does not have access to hazardous voltages within the chassis. However, depending on the user's application configuration, HIGH VOLTAGES HAZARDOUS TO HUMAN SAFETY may be normally generated on the output terminals. The customer/user must ensure that the output power lines are labeled properly as to the safety hazards and that any inadvertent contact with hazardous voltages is prevented.

Guard against risks of electrical shock during open cover checks by not touching any portion of the electrical circuits. Even when power is off, capacitors may retain an electrical charge. Use safety glasses and protective clothing during open cover checks to avoid personal injury by any sudden component failure.

AMETEK Programmable Power Inc., San Diego, California, USA, or any of the subsidiary sales organizations, cannot accept any responsibility for personnel, material or inconsequential injury, loss or damage that results from improper use of the equipment and accessories.

SAFETY SYMBOLS



WARNING: Electrical Shock Hazard.



HAZARD: Strong oxidizer



CAUTION: Read the accompanying message for specific information.



BURN HAZARD: Hot Surface Warning. Allow to cool before servicing.



DO NOT TOUCH: Touching some parts of the instrument without protection or proper tools could result in damage to the part(s) and/or the instrument.



TECHNICIAN SYMBOL: All operations marked with this symbol are to be performed by qualified maintenance personnel only.



ELECTRICAL GROUND: This symbol in the instrument marks the central safety grounding point for the instrument.



STANDBY (SUPPLY): Equipment is in standby mode and still have an active power supply. Disconnect before servicing.



OFF (SUPPLY): Power supply is OFF.



ON (SUPPLY): Power supply is ON.

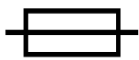

FUSE: Risk of electrical shock or hazard. Disconnect power and use only the specified fuse type and rating.



ALTERNATING CURRENT (AC): AC is present. Avoid contact with live parts to prevent electric shock. Disconnect power before servicing.



DIRECT CURRENT (DC): DC is present. Avoid contact with live parts to prevent electric shock. Disconnect power before servicing.

CONTENTS

1	INTRODUCTION	1-1
1.1	RS232 INTERFACE	1-1
1.2	USB INTERFACE	1-1
1.3	ETHERNET INTERFACE.....	1-1
1.4	IEEE 488.2 GPIB INTERFACE	1-2
2	FEATURES, FUNCTIONS AND SPECIFICATIONS	2-3
2.1	FEATURES OF RS232 INTERFACE	2-3
2.2	FEATURES OF USB INTERFACE	2-3
2.3	FEATURES OF ETHERNET INTERFACE.....	2-4
2.4	FEATURES OF IEEE 488.2 GPIB INTERFACE	2-5
2.5	PROGRAMMABLE FUNCTIONS	2-6
2.6	READBACK FUNCTIONS	2-6
2.7	SPECIFICATIONS	2-7
2.7.1	PROGRAMMING RESOLUTION	2-7
2.7.2	PROGRAMMING ACCURACY	2-7
2.7.3	READBACK RESOLUTION	2-7
2.7.4	READBACK ACCURACY.....	2-7
2.8	MINIMUM SYSTEM REQUIREMENTS	2-7
2.8.1	PC CONNECTION.....	2-7
2.8.2	INTERNET OR LAN CONNECTION	2-8
3	LOCAL/ REMOTE SELECTION.....	3-9
3.1	REMOTE MODE	3-9
4	RS232 CONFIGURATIONS AND REMOTE PROGRAMMING	4-11
4.1	REAR PANEL.....	4-11
4.2	REMOTE PROGRAMMING VIA RS232	4-11
4.2.1	RS232 CONNECTOR PINOUT	4-11
4.2.2	RS232 SETUP PROCEDURE.....	4-12
5	USB CONFIGURATIONS AND REMOTE PROGRAMMING	5-19
5.1	REAR PANEL.....	5-19
5.2	USB SETUP PROCEDURE	5-19
5.2.1	PORT NUMBER IDENTIFICATION	5-19
5.2.2	COMMUNICATION TEST USING SERIAL INTERFACE PROGRAM.....	5-20

- 6 ETHERNET CONFIGURATION AND REMOTE PROGRAMMING6-25**
 - 6.1 REAR PANEL6-25**
 - 6.2 ETHERNET OR LAN CONFIGURATION.....6-25**
 - 6.2.1 ETHERNET CONFIGURATION FACTORY DEFAULTS 6-26
 - 6.3 ETHERNET SETUP PROCEDURE.....6-26**
 - 6.3.1 NETWORK SETUP USING DHCP SERVER 6-26
 - 6.3.2 NETWORK SETUP USING AUTO-IP (DIRECT CONNECTION BETWEEN MI-BEAM POWER SUPPLY AND PC USING CROSS CABLE) 6-29
 - 6.3.3 NETWORK SETUP USING STATIC IP 6-30
 - 6.3.4 RAW SOCKET INTERFACE 6-33
 - 6.3.5 VXI-11 PROTOCOL 6-33
 - 6.3.6 WEB SERVER 6-33
 - 6.4 ETHERNET WEB PAGES, OVERVIEW6-34**
 - 6.4.1 HOME 6-35
 - 6.4.2 IP CONFIGURATION..... 6-36
 - 6.4.3 INTERACTIVE CONTROL..... 6-38
 - 6.4.4 LXI IDENTIFICATION 6-38
- 7 IEEE 488.2 GPIB CONFIGURATIONS AND REMOTE PROGRAMMING7-40**
 - 7.1 REAR PANEL7-40**
 - 7.2 REMOTE PROGRAMMING VIA IEEE 488.2 GPIB CONNECTOR7-40**
 - 7.2.1 ADDRESS SELECTION 7-40
 - 7.2.2 POWER-ON GPIB SERVICE REQUEST (PON SRQ) SELECTION 7-41
 - 7.2.3 SHIELD GROUND 7-41
 - 7.2.4 IEEE 488.2 GPIB SETUP PROCEDURE 7-41
- 8 REMOTE ANALOG PROGRAMMING AND EXTERNAL USER INTERFACES ...8-43**
 - 8.1 REAR PANEL8-43**
 - 8.2 REAR PANEL USER INTERFACE CONNECTORS8-43**
 - 8.2.1 REMOTE EXTERNAL USER CONTROL INTERFACE 8-44
 - 8.2.2 REMOTE INHIBIT SIGNAL..... 8-50
 - 8.2.3 REMOTE ANALOG PROGRAMMING..... 8-52
- 9 RS232/ETHERNET/ IEEE 488.2 GPIB REGISTER COMMAND OPERATION9-67**
 - 9.1 REGISTER DEFINITIONS.....9-67**
 - 9.1.1 PROTECTION CONDITION AND PROTECTION EVENT STATUS REGISTER
9-67
 - 9.1.2 STANDARD EVENT STATUS REGISTER (ESR)..... 9-68
 - 9.1.3 SCPI STATUS BYTE 9-69
 - 9.1.4 ERROR OR EVENT QUEUE..... 9-71

9.1.5	SERIAL POLL OPERATION	9-72
9.1.6	FAULT STATUS	9-72
9.2	SCPI CONFORMANCE INFORMATION	9-80
9.2.1	PARAMETER DEFINITIONS	9-80
9.2.2	CONVENTIONS	9-81
9.2.3	QUERIES.....	9-81
9.3	IEEE 488.2 COMMON COMMAND SUBSYSTEM.....	9-81
9.4	SOURCE SCPI COMMAND SYSTEM	9-83
9.4.1	SOURCE SCPI COMMAND SUMMARY	9-83
9.4.2	SOURCE SCPI COMMAND REFERENCE	9-87
9.5	PVSIM SCPI COMMAND SYSTEM	9-93
9.5.1	PVSIM SCPI COMMAND SUMMARY.....	9-93
9.5.2	PVSIM SCPI COMMAND REFERENCE.....	9-96
9.6	BATSIM SCPI COMMAND SYSTEM.....	9-110
9.6.1	BATSIM SCPI COMMAND SUMMARY	9-110
9.6.2	BATTSIM SCPI COMMAND REFERENCE	9-112
9.7	BATTEST SCPI COMMAND SYSTEM	9-117
9.7.1	BATTEST SCPI COMMAND SUMMARY	9-117
9.7.2	BATTEST SCPI COMMAND REFERENCE.....	9-119
9.8	CALIBRATION INIT AND PONS SCPI COMMAND SUBSYSTEM	9-122
9.8.1	CALIBRATION INIT AND PONS SCPI COMMAND SUMMARY	9-122
9.8.2	CALIBRATION INIT AND PONS SCPI COMMAND REFERENCE	9-126
9.9	CALIBRATION SCPI COMMAND SUBSYSTEM.....	9-134
9.9.1	CALIBRATION SCPI COMMAND SUMMARY.....	9-134
9.9.2	CALIBRATION SCPI COMMAND REFERENCE.....	9-137
9.10	LIST SCPI COMMAND SUBSYSTEM	9-142
9.10.1	LIST SCPI COMMAND SUMMARY	9-142
9.10.2	LIST SCPI COMMAND REFERENCE	9-143
9.11	MEASURE SCPI COMMAND SUBSYSTEM	9-145
9.11.1	MEASURE SCPI COMMAND SUMMARY	9-145
9.11.2	MEASURE SCPI COMMAND REFERENCE	9-145
9.12	OUTPUT SCPI COMMAND SUBSYSTEM	9-146
9.12.1	OUTPUT SCPI COMMAND SUMMARY	9-146
9.12.2	OUTPUT SCPI COMMAND REFERENCE	9-147
9.13	TRIGGER SCPI COMMAND SUBSYSTEM.....	9-148
9.13.1	TRIGGER SCPI COMMAND SUMMARY	9-149
9.13.2	TRIGGER SCPI COMMAND REFERENCE	9-149

9.14	STATUS SCPI COMMAND SUBSYSTEM	9-149
9.14.1	STATUS SCPI COMMAND SUMMARY	9-149
9.14.2	STATUS SCPI COMMAND REFERENCE	9-149
9.15	SYSTEM SCPI COMMAND SUBSYSTEM	9-149
9.15.1	SYSTEM SCPI COMMAND SUMMARY	9-150
9.15.2	SYSTEM SCPI COMMAND REFERENCE.....	9-151
10	CALIBRATION	10-155
10.1	CALIBRATION EQUIPMENT	10-155
10.2	CALIBRATION PROCEDURES	10-155
10.2.1	PREPARATION FOR CALIBRATION.....	10-155
10.2.2	LOCAL SENSE VOLTAGE PROGRAMMING CALIBRATION.....	10-156
10.2.3	REMOTE SENSE VOLTAGE PROGRAMMING CALIBRATION	10-158
10.2.4	CURRENT PROGRAMMING CALIBRATION	10-160
10.2.5	ANALOG PROGRAM ADJUSTMENT	10-162
10.2.6	REMOTE MONITOR OUTPUTS CALIBRATION	10-167

LIST OF TABLES

Table 4-1. RS-232C Interface Connector Type	4-12
Table 4-2. RS-232C Interface Connector Pinout	4-12
Table 4-3. Configuration requirements for RS232	4-13
Table 4-4. RS-232C Interface Connector Pinout	4-13
Table 6-1. Ethernet Configuration Factory Defaults	6-26
Table 8-1: External User Control Interface connector Type	8-44
Table 8-2: External User Control Interface Characteristics	8-47
Table 8-3: External User Control Interface Pin Out details	8-50
Table 9-1. Standard Event Status Register	9-68
Table 9-2: SCPI Status Byte	9-70
Table 9-3: SCPI Error Codes	9-72
Table 9-4: Fault Status	9-80
Table 9-5. Parameter Definitions	9-81
Table 9-6. Common Command Subsystem	9-83
Table 9-7. Source SCPI Command Reference	9-93
Table 9-8: PVSIM SCPI Command reference	9-110
Table 9-9: BATSIM SCPI Command reference	9-117
Table 9-10: BATTEST SCPI Command reference	9-122
Table 9-11. Cal INIT and PONS SCPI Command Reference	9-134
Table 9-12. Calibration SCPI Command Reference	9-142
Table 9-13. List SCPI Command Reference	9-144
Table 9-14. Measure SCPI Command Reference	9-146
Table 9-15. Output SCPI Command Reference	9-148
Table 9-16. Trigger SCPI Command Reference	9-149
Table 9-17. Status SCPI Command Reference	9-149
Table 9-18. System SCPI Command Reference	9-153
Table 10-1. Calibration Equipment	10-155

LIST OF FIGURES

Figure 3-1. Local/Remote Screen 3-9

Figure 3-2. Dashboard Screen..... 3-10

Figure 4-1. Rear Panel – RS232 Interface 4-11

Figure 4-2. RS-232 Interface Connector 4-12

Figure 4-3. RS232 Communications Cable Pinout..... 4-13

Figure 4-4. RS232 Configure 4-14

Figure 4-5. RS232 Screen – Baud Rate..... 4-14

Figure 4-6. Port Setting in Tera Term..... 4-15

Figure 4-7. Baud rate Setting in Tera Term 4-16

Figure 4-8. Terminal option in Tera Term 4-16

Figure 4-9. Terminal Setup in Tera Term 4-17

Figure 5-1. Rear Panel –USB Interface 5-19

Figure 5-2. Port identification..... 5-20

Figure 5-3. Port identification in Tera Term..... 5-21

Figure 5-4. Baud rate selection in Tera Term 5-21

Figure 5-5. Terminal selection in Tera Term..... 5-22

Figure 5-6. Terminal setup in Tera Term 5-23

Figure 6-1. Rear Panel - Ethernet Interface 6-25

Figure 6-2: LAN Screen - Configure..... 6-27

Figure 6-3. LAN Screen..... 6-27

Figure 6-4: LAN Screen – Settings..... 6-28

Figure 6-5: RS232 Screen - Settings..... 6-29

Figure 6-6. LAN configure - Settings 6-31

Figure 6-7. LAN Screen - Configure Static IP 6-31

Figure 6-8. LAN Screen - Subnet Mask..... 6-32

Figure 6-9. LAN Screen - Gateway Address..... 6-32

Figure 6-10. Mi-BEAM Series power supply Banner and Tab 6-34

Figure 6-11. Login Window..... 6-34

Figure 6-12. Mi-Beam Series power supply Home Page..... 6-35

Figure 6-13. Mi-Beam Series power supply Device identify screen..... 6-36

Figure 6-14. IP Configuration Page..... 6-36

Figure 6-15. Interactive Control Page 6-38

Figure 6-16. LXI Identification Page..... 6-39

Figure 7-1. Rear Panel – IEEE 488.2 GPIB Interface 7-40

Figure 7-2: GPIB Screen 7-41

Figure 8-1: Rear Panel – External Analog..... 8-43

Figure 8-2. External User Control Interface connector..... 8-44

Figure 8-3. Analog Control connector 8-52

Figure 8-4. Remote Voltage Programming by Voltage source..... 8-52

Figure 8-5. Remote Over Voltage Programming by Voltage source..... 8-53

Figure 8-6. Remote Voltage Programming by Current Source	8-54
Figure 8-7. Remote Current Programming by Voltage Source	8-55
Figure 8-8. Remote Current Programming by Current Source	8-56
Figure 8-9. Voltage Monitor	8-56
Figure 8-10. Current Monitor	8-57
Figure 8-11. Dio Output 1	8-58
Figure 8-12. Dio Output 2	8-59
Figure 8-13. SOURCE/SINK Output	8-60
Figure 8-14. TRIG_OUT	8-60
Figure 8-15. DIO_ON/OFF_STAT	8-61
Figure 8-16. DIO_CC/CV_OUT	8-61
Figure 8-17. DIO_FAULT_OUT	8-62
Figure 8-18. TRIG_IN	8-63
Figure 8-19. DIO_OUTPUT_ON/OFF	8-63
Figure 8-20. Digital IN 1	8-64
Figure 8-21. Digital IN 2	8-64
Figure 8-22. Digital IN 3	8-65
Figure 8-23. Remote Inhibit Active Voltage	8-65
Figure 8-24. Remote Inhibit Contact Closure	8-66
Figure 9-1. Standard Event Status and Standard Event Status Enable Register	9-69
Figure 9-2. SCPI Status Byte and Service Request Enable Register	9-70

This page intentionally left blank

1

INTRODUCTION

This manual provides instructions for remote programming control and monitoring of Mi-BEAM Series power supplies. For easy navigation, the manual separates setup instructions for RS232, USB, IEEE 488.2 GPIB, and Ethernet interfaces. The instructions then converge where they are common to all interface options. The Mi-BEAM Series power supplies come with default interfaces of RS232, USB, and Ethernet. IEEE 488.2 GPIB is an optional interface. Use this programming manual in conjunction with your Mi-BEAM Series power supplies operational manual.

1.1 RS232 INTERFACE

If you are using the RS232 interface, refer to the following chapters:

- a) **Chapter 2** : Features, Functions, and Specifications
- b) **Chapter 3** : Local/Remote Selection
- c) **Chapter 4** : RS232 Configurations and Remote Programming
- d) **Chapter 8** : Remote Analog Programming and External User Control Interfaces
- e) **Chapter 10** : Calibration

1.2 USB INTERFACE

If you are using the USB interface, refer to the following chapters:

- a) **Chapter 2** : Features, Functions, and Specifications
- b) **Chapter 3** : Local/Remote Selection
- c) **Chapter 5** : USB Configurations and Remote Programming
- d) **Chapter 8** : Remote Analog Programming and External User Control Interfaces
- e) **Chapter 10** : Calibration

1.3 ETHERNET INTERFACE

If you are using the Ethernet interface, refer to the following chapters:

- a) **Chapter 2** : Features, Functions, and Specifications
- b) **Chapter 3** : Local/Remote Selection
- c) **Chapter 6** : Ethernet Configuration and Remote Programming
- d) **Chapter 8** : Remote Analog Programming and External User Control Interfaces
- e) **Chapter 10** : Calibration

1.4 IEEE 488.2 GPIB INTERFACE

If you are using the IEEE 488.2 GPIB interface, refer to the following chapters:

- a) **Chapter 2** : Features, Functions, and Specifications
- b) **Chapter 3** : Local/Remote Selection
- c) **Chapter 7** : IEEE 488.2 GPIB Configuration and Remote Programming
- d) **Chapter 8** : Remote Analog Programming and External User Control Interfaces
- e) **Chapter 10** : Calibration

2

FEATURES, FUNCTIONS AND SPECIFICATIONS

2.1 FEATURES OF RS232 INTERFACE

- a) Programming and readback of voltage and current
- b) Programmable overvoltage protection with reset
- c) SCPI compliant command set
- d) User selectable operating modes Bi-Directional, source, eLoad, Battery Simulator, Battery Test & PV simulator
- e) User selectable programming types Current and Voltage.
 - User selectable regulation settings for current programming type Constant Current (CC), Constant Current/Constant Voltage (CC/CV), Constant Current/Constant Power (CC/CP), Constant Power/Constant Current (CP/CC), Constant Resistance/Constant Current (CR/CC).
 - User selectable regulation settings for voltage programming type Constant Voltage (CV), Constant Voltage/Constant Current (CV/CC), Constant Voltage/Constant Power (CV/CP), Constant Power/Constant Voltage (CP/CV), Constant Resistance/Constant Voltage (CR/CV) and Constant Voltage Series Resistance (CV-Ser.Res).
- f) Voltage Ramp and Current Ramp functions
- g) Voltage Transient List and Current Transient List functions
- h) Soft calibration
- i) Rear panel RS232 control interface
- j) Rear panel Remote Analog Programming and External user control interface (Common to all interfaces)

2.2 FEATURES OF USB INTERFACE

- a) Programming and readback of voltage and current
- b) Programmable overvoltage protection with reset

- c) SCPI compliant command set
- d) User selectable operating modes Bi-Directional, source, eLoad, Battery Simulator, Battery Test & PV simulator
- e) User selectable programming types Current and Voltage.
 - User selectable regulation settings for current programming type Constant Current (CC), Constant Current/Constant Voltage (CC/CV), Constant Current/Constant Power (CC/CP), Constant Power/Constant Current (CP/CC), Constant Resistance/Constant Current (CR/CC).
 - User selectable regulation settings for voltage programming type Constant Voltage (CV), Constant Voltage/Constant Current (CV/CC), Constant Voltage/Constant Power (CV/CP), Constant Power/Constant Voltage (CP/CV), Constant Resistance/Constant Voltage (CR/CV) and Constant Voltage Series Resistance (CV-Ser. Res).
- f) Voltage Ramp and Current Ramp functions
- g) Voltage Transient List and Current Transient List functions
- h) Soft calibration
- i) Rear panel USB control interface
- j) Rear panel Remote Analog Programming and External user control interface (Common to all interfaces)

2.3 FEATURES OF ETHERNET INTERFACE

- a) Ethernet/LAN connectivity, 10/100base-T compatible
- b) Fully **LXI**™ (LAN eXtensions for Instrumentation) class C compliant
- c) Built-in Web Server for direct control using Web Browser
- d) Programming and readback of voltage and current
- e) Programmable overvoltage protection with reset
- f) SCPI compliant command set
- g) User selectable operating modes Bi-Directional, source, eLoad, Battery Simulator, Battery Test & PV simulator
- h) User selectable programming types Current and Voltage.
 - User selectable regulation settings for current programming type Constant Current (CC), Constant Current/Constant Voltage (CC/CV), Constant Current/Constant Power (CC/CP), Constant Power/Constant Current (CP/CC), Constant Resistance/Constant Current (CR/CC).

- User selectable regulation settings for voltage programming type Constant Voltage (CV), Constant Voltage/Constant Current (CV/CC), Constant Voltage/Constant Power (CV/CP), Constant Power/Constant Voltage (CP/CV), Constant Resistance/Constant Voltage (CR/CV) and Constant Voltage Series Resistance (CV-Ser. Res).
- i) Voltage Ramp and Current Ramp functions
 - j) Voltage Transient List and Current Transient List functions
 - k) Field-upgradable firmware via Ethernet
 - l) Full calibration through software control
 - m) Rear panel Ethernet control interface
 - n) Rear panel Remote Analog Programming and External user control interface (Common to all interfaces)

2.4 FEATURES OF IEEE 488.2 GPIB INTERFACE

- a) Programming and readback of voltage and current
- b) Programmable overvoltage protection with reset
- c) IEEE 488.2 and SCPI compliant command set
- d) User selectable operating modes Bi-Directional, source, eLoad, Battery Simulator, Battery Test & PV simulator
- e) User selectable programming types Current and Voltage.
 - User selectable regulation settings for current programming type Constant Current (CC), Constant Current/Constant Voltage (CC/CV), Constant Current/Constant Power (CC/CP), Constant Power/Constant Current (CP/CC), Constant Resistance/Constant Current (CR/CC).
 - User selectable regulation settings for voltage programming type Constant Voltage (CV), Constant Voltage/Constant Current (CV/CC), Constant Voltage/Constant Power (CV/CP), Constant Power/Constant Voltage (CP/CV), Constant Resistance/Constant Voltage (CR/CV) and Constant Voltage Series Resistance (CV-Ser. Res).
- f) Voltage Ramp and Current Ramp functions
- g) Voltage Transient List and Current Transient List functions
- h) Soft calibration
- i) Rear panel GPIB IEEE 488.2 control interface

- j) Rear panel Remote Analog Programming and External user control interface (Common to all interfaces)

2.5 PROGRAMMABLE FUNCTIONS

The below functions are common to all communication interfaces (RS232, USB, IEEE 488.2 GPIB and Ethernet).

- a) Output voltage, current and power
- b) User limits for voltage, current and power
- c) Overvoltage protection
- d) Overcurrent protection
- e) Output enable/disable
- f) Maskable fault interrupt
- g) Hold and trigger
- h) External relay control
- i) Full calibration

2.6 READBACK FUNCTIONS

The below functions are common to all communication interfaces (RS232,USB, IEEE 488.2 GPIB and Ethernet).

- a) Actual measured voltage, current and power
- b) Voltage, current and power settings
- c) User voltage, current and power limits
- d) Overvoltage and overcurrent protection settings
- e) Status and Accumulated Status registers
- f) Programming error codes
- g) Fault codes
- h) Manufacturer, power supply model, and firmware version identification

2.7 SPECIFICATIONS

Specifications are subject to change without notice. Refer to your Mi-BEAM Series power supply operation manual for the effects of line regulation, load regulation, and temperature specifications. Specifications are common to all interfaces (RS232,USB, IEEE 488.2 GPIB, and Ethernet).

2.7.1 PROGRAMMING RESOLUTION

Voltage Output:	0.002% of full scale
Current Output:	0.002% of full scale
Overvoltage Protection:	0.1% of full scale (full scale is 110% of max output voltage)
Power Output:	0.01% of full scale

2.7.2 PROGRAMMING ACCURACY

Voltage Output:	$\pm 0.1\%$ of rated output voltage
Current Output:	$\pm 0.4\%$ of rated output current ⁽¹⁾
Overvoltage Protection:	$\pm 1.0\%$ of rated output voltage
Power Output:	$\pm 0.75\%$ of rated output power

⁽¹⁾After 30 minutes of operation with fixed line, load, and temperature.

2.7.3 READBACK RESOLUTION

Voltage Output:	$\pm 0.002\%$ of full scale
Current Output:	$\pm 0.002\%$ of full scale
Power Output:	$\pm 0.01\%$ of full scale

2.7.4 READBACK ACCURACY

Voltage Output:	$\pm 0.1\%$ of full-scale output voltage
Current Output:	$\pm 0.4\%$ of full-scale output current ⁽¹⁾
Power Output:	$\pm 0.75\%$ of rated output power

⁽¹⁾After 30 minutes of operation with fixed line, load, and temperature.

2.8 MINIMUM SYSTEM REQUIREMENTS

The minimum software and equipment requirements to operate the Mi-BEAM Series power supply depend on whether it is connected directly to a PC, the Internet, or a Local Area Network (LAN).

2.8.1 PC CONNECTION

To operate the Mi-BEAM Series power supply with the Ethernet option connected directly to a PC (without Internet or LAN connection), the following are required:

- a) Pentium-based laptop or desktop computer running Microsoft Windows 10 (or better)
- b) Ethernet-based Network Interface Card (NIC) or built-in port capable of 10/100 MBit operation
- c) CAT 5 Ethernet crossover cable
- d) Web browser

2.8.2 INTERNET OR LAN CONNECTION

- a) To operate Mi-BEAM Series power supplies connected to the Internet or a LAN, the following are required:
 - b) Pentium-based laptop or desktop computer running Microsoft Windows 10 (or better)
 - c) Ethernet-based Network Interface Card (NIC) or built-in port capable of 10/100 MBit operation
 - d) Appropriate Ethernet modem for Internet connection, or
 - e) Switch or hub (Linksys brand strongly recommended) for LAN connection
 - f) Standard CAT 5 Ethernet interconnect cable
 - g) Web browser

3

LOCAL/ REMOTE SELECTION

3.1 REMOTE MODE

The unit can be set to Remote mode by sending the command 'SYST:LOCAL 0' using any of the interfaces available on the unit (RS232, USB, LAN, and GPIB).

NOTE: The unit can also be set to Remote mode by sending SCPI command (to set any parameter to the power supply) using any of the interfaces available on the unit. Refer to Figure 3-1.

The screen color changes based on the selected mode. For detailed information on color variations, refer to the operational manual (P/N: M587351-01).

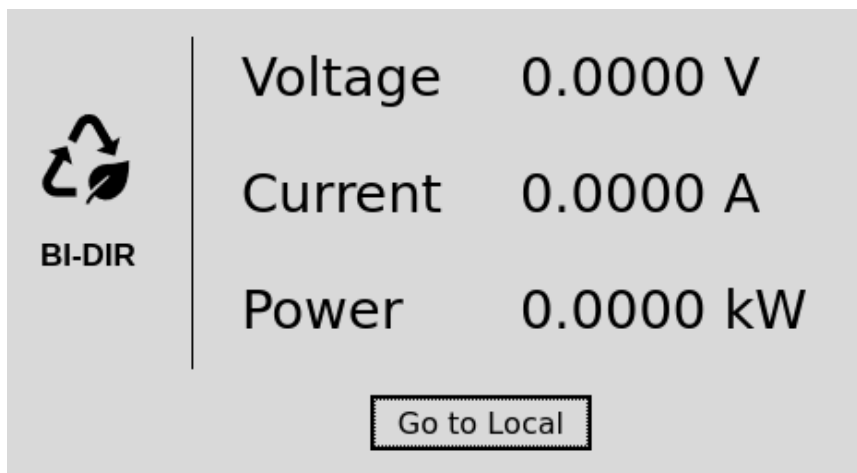

Figure 3-1. Local/Remote Screen

Upon clicking the 'Go To Local' button, the Mi-BEAM power supply front panel screen will navigate to the 'Dashboard'. Refer to Figure 3-2.



Figure 3-2. Dashboard Screen

4

RS232 CONFIGURATIONS AND REMOTE PROGRAMMING

4.1 REAR PANEL

This section provides an illustration of the Mi-BEAM Series power supply's rear panel layout, refer to Figure 4-1. Regardless of the layout, the component functions are common across all models, and those relevant to the RS232 options are described here.

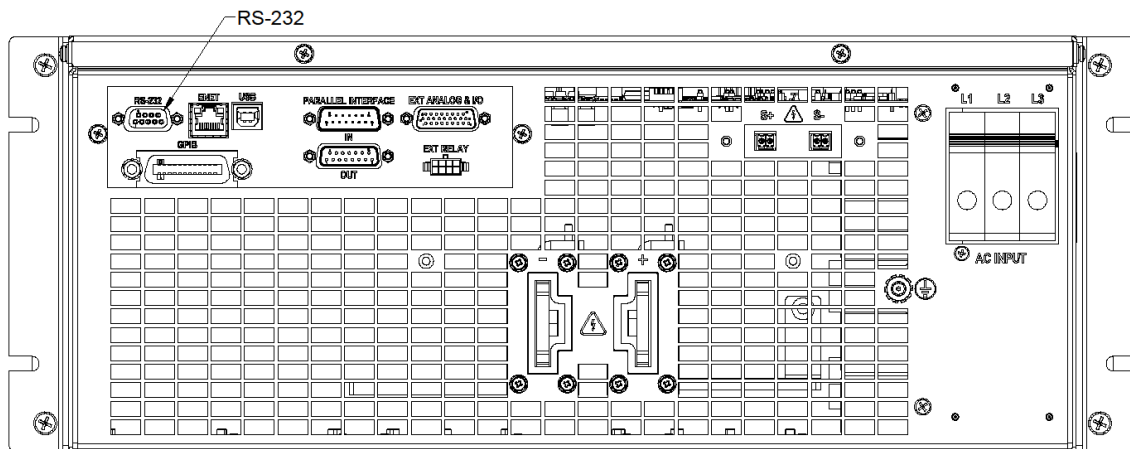

Figure 4-1. Rear Panel – RS232 Interface

4.2 REMOTE PROGRAMMING VIA RS232

4.2.1 RS232 CONNECTOR PINOUT

The RS232 interface operates at a default baud rate of 9600, which is selectable from 9600 to 115200. The RS232 interface is accessible through the rear panel DB9 connector, labeled 'RS-232' on the power supply's rear panel. Refer to Figure 4-1 and Figure 4-2.

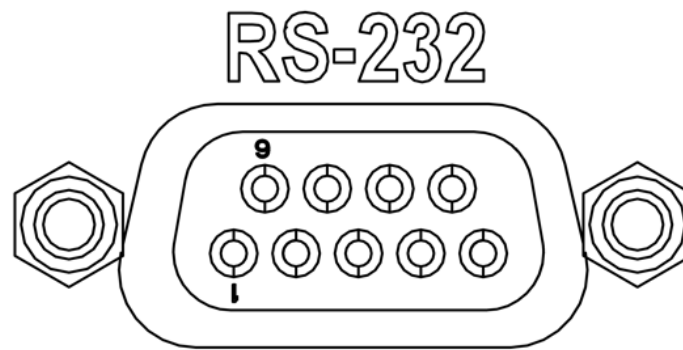

Figure 4-2. RS-232 Interface Connector

CONNECTOR	TYPE
RS-232C Interface	9-contact receptacle (female) Subminiature-D.

Table 4-1. RS-232C Interface Connector Type

Pin #	Name	DCE Signal	Direction
1	N/C	N/A	N/A
2	TxD	Transmit Data	Output
3	RxD	Receive Data	Input
4	N/C	N/A	N/A
5	Common	N/A	N/A
6	N/C	N/A	N/A
7	RTS	Request to Send	Input
8	CTS	Clear to Send	Output
9	N/C	N/A	N/A

Table 4-2. RS-232C Interface Connector Pinout

4.2.2 RS232 SETUP PROCEDURE

This section provides a quick reference for the configuration requirements of the RS232 interface.

PARAMETER	SETTING	NOTES
Baud Rate	Selectable from 9600 to 115200	The baud rate is selectable through the front panel.
Data Bits	8	Not Selectable
Stop Bits	1	Not Selectable
Parity	None	Not Selectable

PARAMETER	SETTING	NOTES
Incoming Termination Character	CR (Carriage Return): HEX, 0x0d (DEC, 13),	Not Selectable
Outgoing Termination Character(s)	CR (Carriage Return): HEX, 0x0d 0x0a (DEC, 13)	Not Selectable

Table 4-3. Configuration requirements for RS232

a) Build an RS232 communications cable as per the pinout description illustrated in Figure 4-3 and Table 4-4 (with crossover of signals Rx/Tx and CTS/RTS):

D-SUBMINIATURE 9-PIN CONNECTOR MALE CONNECTOR (POWER SUPPLY INTERFACE)	D-SUBMINIATURE 9-PIN CONNECTOR FEMALE SOCKET (PC INTERFACE)
2(RxD)	3(TxD)
3(TxD)	2(RxD)
No Connection	No Connection
5(GND)	5(GND)
7(RTS)	8(CTS)
8(CTS)	7(RTS)

Table 4-4. RS-232C Interface Connector Pinout

- TxD-Transmit
- RxD-Receive
- RTS-Request to Send
- CTS-Clear to Send

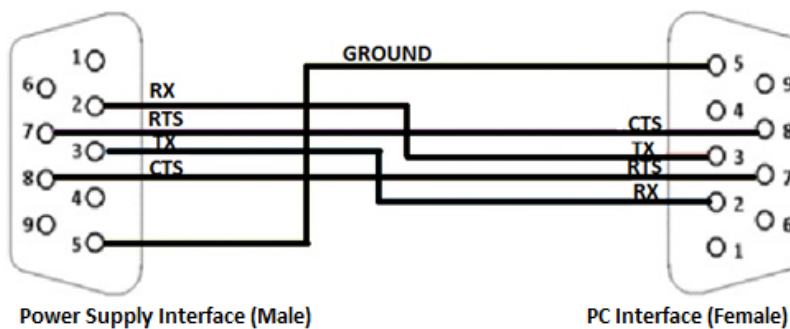

Figure 4-3. RS232 Communications Cable Pinout

- b) Connect power to the unit and turn it ON.
- c) The baud rate is selectable through the front panel, refer to Figure 4-5. Change the baud rate for RS232 to 9600.

- To navigate to RS232, Configure screen,

Go to Home → Control Interface → RS232 → RS232 Configure.

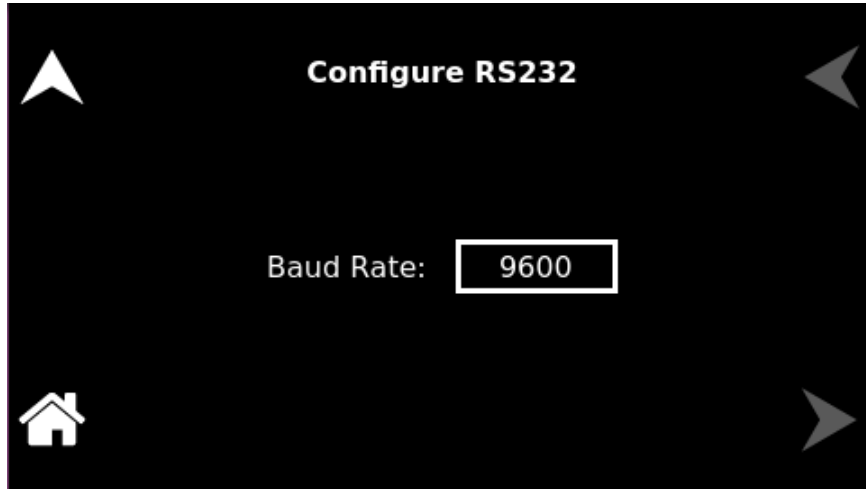

Figure 4-4. RS232 Configure

- d) Upon tapping the text box, the following baud rate selection screen will appear.

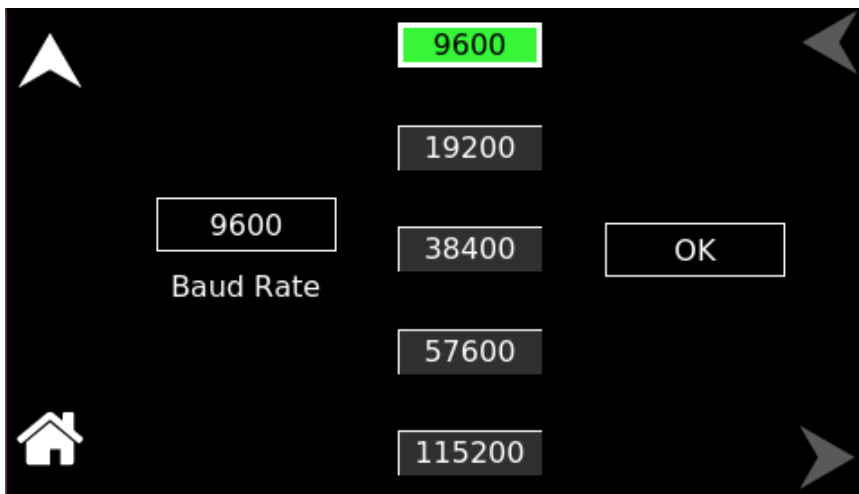

Figure 4-5. RS232 Screen – Baud Rate

- e) Use one of the available programs for serial communication in PC, such as 'Tera Term'.
- f) If the user chooses to use 'Tera Term':
- Select the serial option in the 'Tera Term' window, choose the port as 'COM1: Communication Port [COM 1]', and press 'OK'. Refer to Figure 4-6.

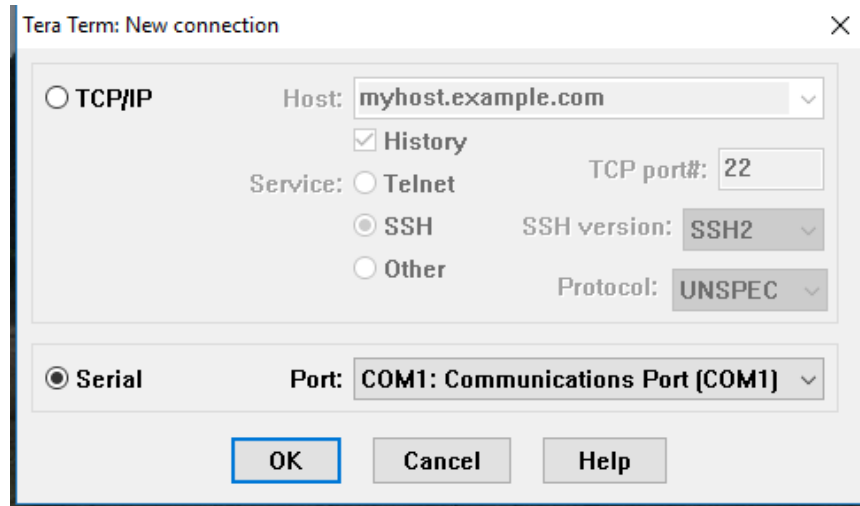

Figure 4-6. Port Setting in Tera Term

- Select the 'Setup' option and choose the 'Serial port' in the setup window.
- Set the features in 'Serial port setup' as follows. Refer to Figure 4-7.

Port : **COM 1**
 Baud rate : **9600**
 Data: : **8 bit**
 Parity : **none**
 Stop : **1 bit**
 Flow Control : **None**
 Transmit Delay : **0**

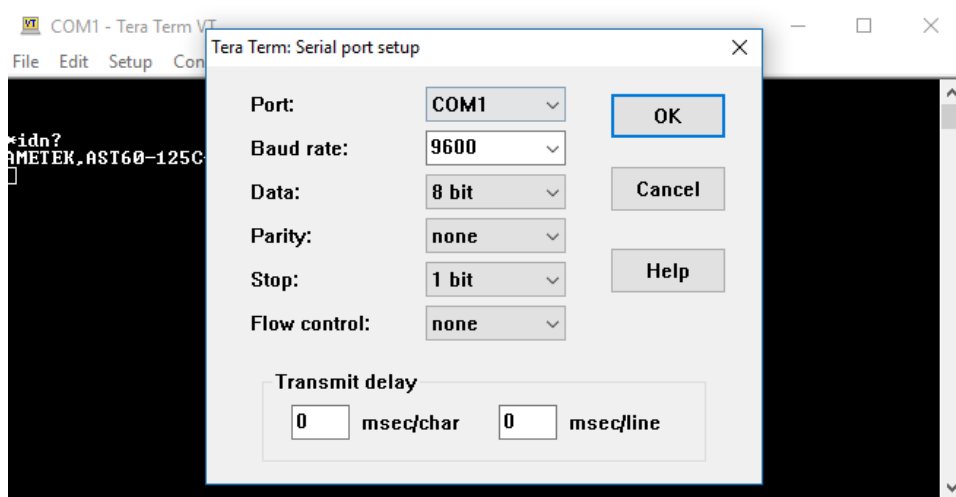

Figure 4-7. Baud rate Setting in Tera Term

- Choose the 'Setup' option and select the 'Terminal' from 'COM 1-Tera Term VT'. Refer to Figure 4-8.

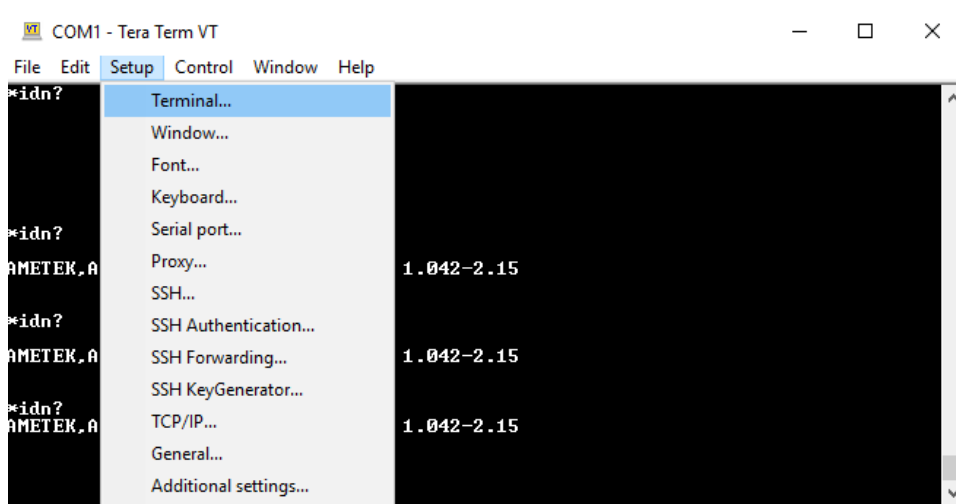

Figure 4-8. Terminal option in Tera Term

- Change the settings as per the screen below. Refer to Figure 4-9.

Terminal Size	80x24
Term size = win size	✓
Terminal ID	VT100
Coding (receive)	UTF-8
Receive	CR
Transmit	CR+LF

Local echo	✓
Coding (transmit)	UTF-8
Locale	american

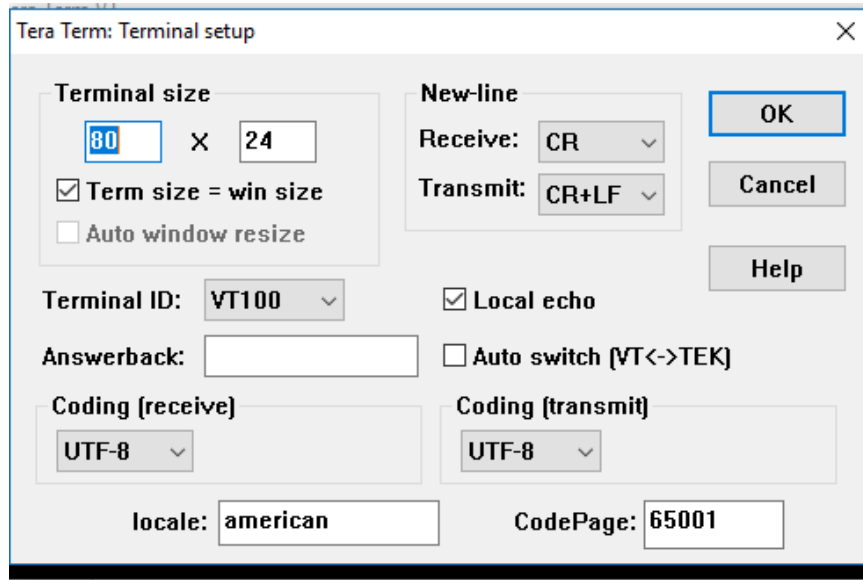

Figure 4-9. Terminal Setup in Tera Term

- Test the communication interface by issuing the '*IDN?' Command. This returns the supply's manufacturer name, model, serial numbers, and software version(s). This command does not affect the output of the supply.

This page intentionally left blank

5

USB CONFIGURATIONS AND REMOTE PROGRAMMING

5.1 REAR PANEL

This section provides an illustration of the Mi-BEAM Series power supply's rear panel layout, refer to Figure 5-1. Regardless of the layout, the component functions are common across all models, and those relevant to the USB options are described here.

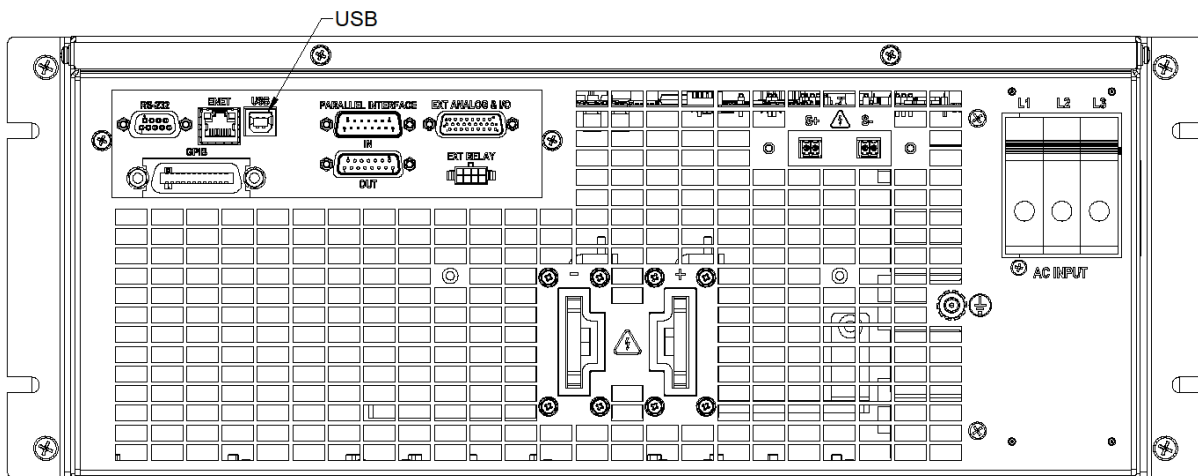

Figure 5-1. Rear Panel –USB Interface

5.2 USB SETUP PROCEDURE

5.2.1 PORT NUMBER IDENTIFICATION

Port Number of the Mi-Beam Series power supply can be identified in the device manager by following the steps below;

- Navigate to device manager in the windows system.
- Go to Ports and check for the new COM port available in the list, refer to Figure 5-2.

NOTE: If Multiple COM ports are shown, disconnect all the COM ports and connect only the Mi-Beam power supply and check for the new COM port.

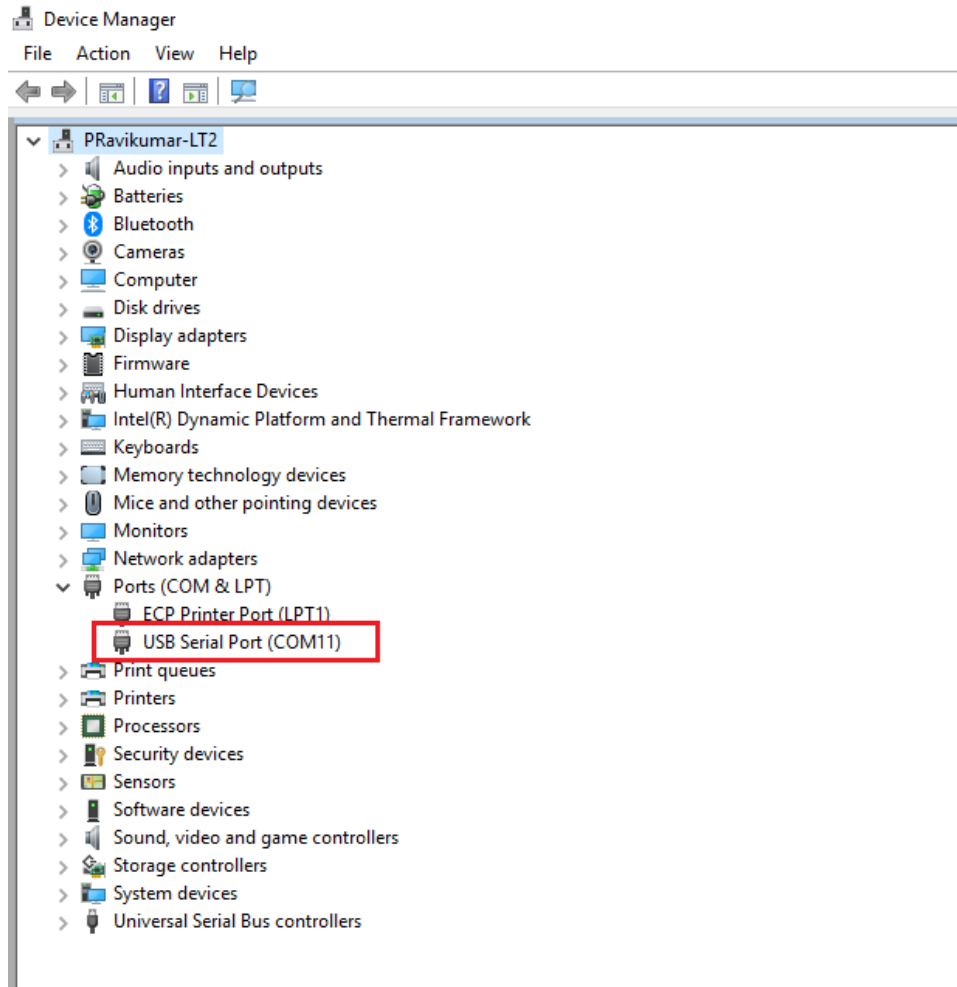

Figure 5-2. Port identification

5.2.2 COMMUNICATION TEST USING SERIAL INTERFACE PROGRAM

- a) Use one of the available programs for serial communication, such as 'Tera Term'.
- b) If the user chooses to use 'Tera Term';
 - Select the 'Serial' option in the 'Tera Term' window, choose the port as 'COM 11: USB Serial Port [COM 11]' identified in the Device Manager, and press 'OK'. Refer to Figure 5-3.

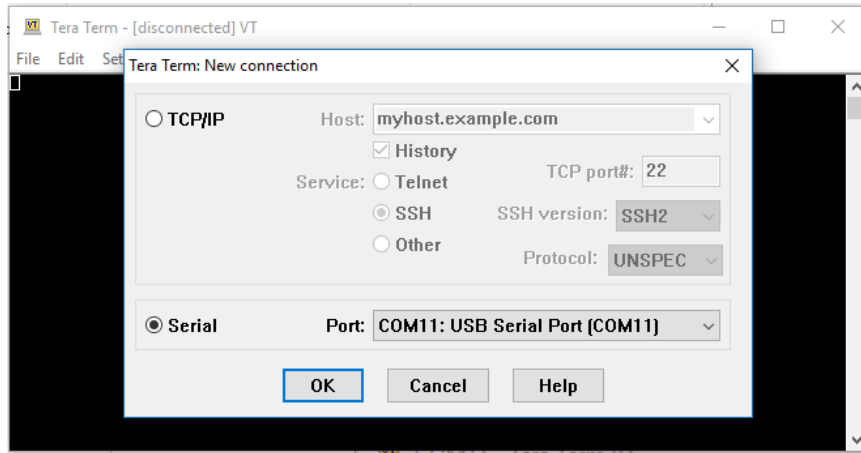

Figure 5-3. Port identification in Tera Term

- Select the 'Setup' option and choose the 'Serial port' in the setup window.
- Set the features in 'Serial port setup' as follows, refer to Figure 5-4:

Port : **COM 11**
 Baud rate : **115200**
 Data: : **8 bit**
 Parity : **none**
 Stop : **1 bit**
 Flow Control : **none**
 Transmit Delay : **0**

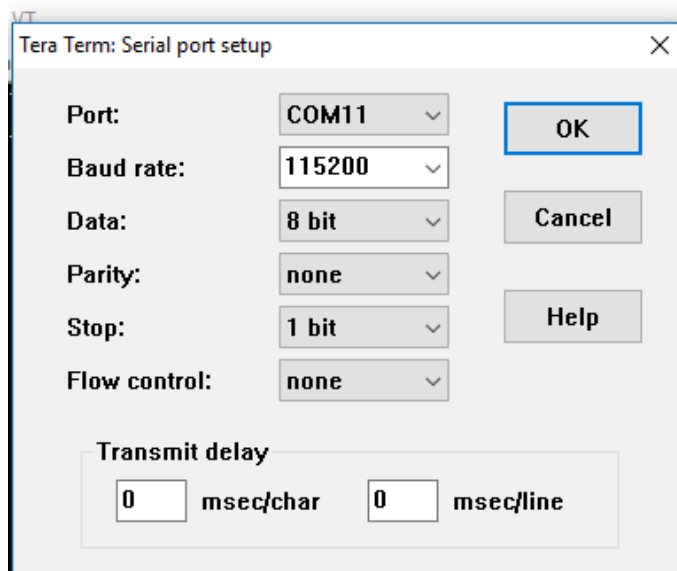

Figure 5-4. Baud rate selection in Tera Term

- Select the 'Setup' option and choose the 'Terminal' from 'COM 1-Tera Term VT'. Refer to Figure 5-5.

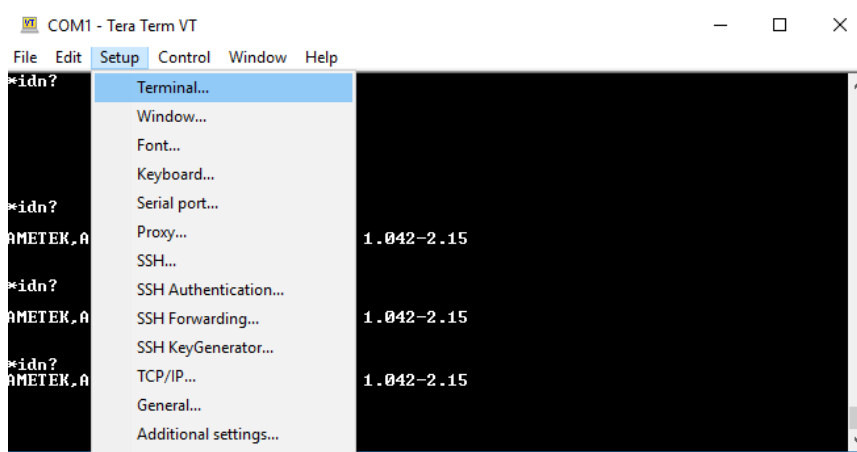

Figure 5-5. Terminal selection in Tera Term

- Change the settings as per the screen below. Refer to Figure 5-6.

Terminal Size	80×24
Term size = win size	✓
Terminal ID	VT100
Coding (receive)	UTF-8
Receive	CR
Transmit	CR+LF
Local echo	✓
Coding (transmit)	UTF-8
Locale	american
CodePage	65001

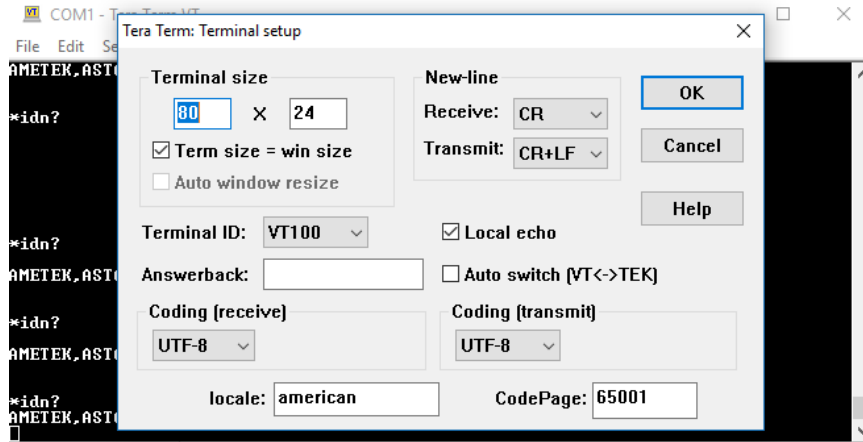

Figure 5-6. Terminal setup in Tera Term

- Test the communication interface by issuing the '*IDN?' Command. This returns the supply's manufacturer name, model, serial numbers, and software version(s). This command does not affect the output of the supply.

This page intentionally left blank

6

ETHERNET CONFIGURATION AND REMOTE PROGRAMMING

6.1 REAR PANEL

This section provides an illustration of the Mi-BEAM Series power supply's rear panel layout, refer to Figure 6-1. Regardless of the layout, the component functions are common across all models, and those relevant to the Ethernet option are described here.

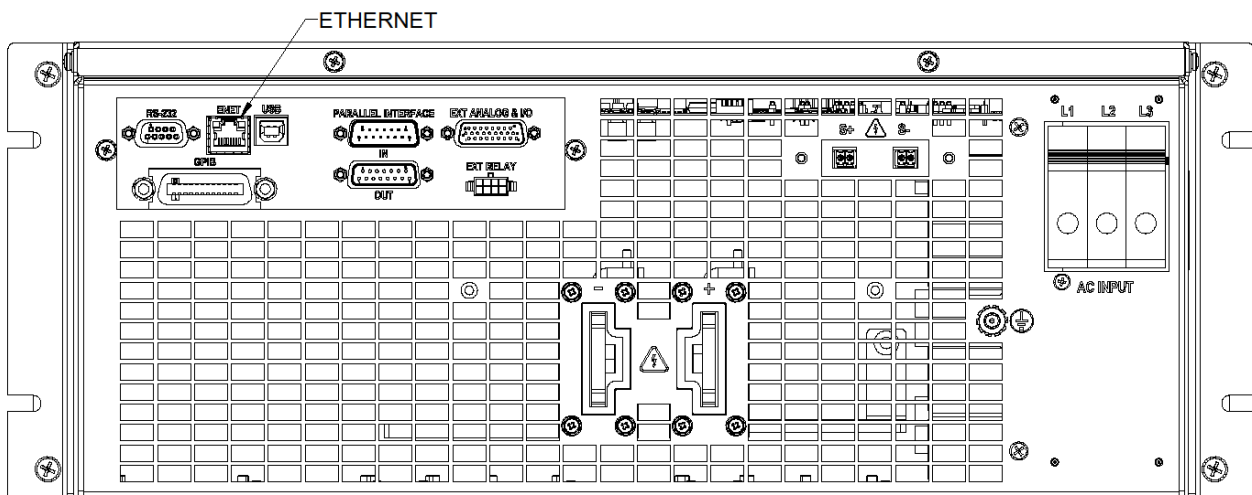

Figure 6-1. Rear Panel - Ethernet Interface

6.2 ETHERNET OR LAN CONFIGURATION

- a) Ethernet Standard : IEEE-802.3 compliant
- b) Technology : 10/100Base-T
- c) Protocol : TCP/IP, IPV4
- d) ICMP (ping server) : Always Enabled
- e) mDNS/DNS-SD : Always Enabled
- f) IP Address Assignment : Via DHCP or Static IP

g) VXI-11 Discovery : Supported

6.2.1 ETHERNET CONFIGURATION FACTORY DEFAULTS

PARAMETER	DEFAULT
Host Name	AST<base model>-<last four digits of serial number>
Description	AST Power Supply <base model>
IP Address	DHCP-acquired, If DHCP server absent, assigned via Auto-IP ⁽¹⁾
Subnet Mask	DHCP-acquired, If DHCP server absent, assigned via Auto-IP ⁽¹⁾
Gateway	DHCP-acquired, If DHCP server absent, assigned via Auto-IP ⁽¹⁾
DNS Server	0.0.0.0
Listening Port	52000
User ID	Admin
Password	Password

⁽¹⁾ The Ethernet interface provides the opportunity to assign an IP address via Auto-IP. If DHCP server fails to assign an IP address and Auto-IP setting is 'ON', the unit gets an IP address in the range of 169.254.X.X

Table 6-1. Ethernet Configuration Factory Defaults

6.3 ETHERNET SETUP PROCEDURE

There are three ways to set up the Ethernet network in the Mi-Beam series power supply:

- a) Network setup using DHCP Server
- b) Network setup using Auto-IP (Direct connection between Mi-Beam power supply and PC using a cross cable)
- c) Network setup using Static IP

The network setups are described in the subsections that follow. Use the setup procedure that applies to the system and application to configure the Ethernet.

NOTE: When connecting the Mi-Beam Series power supply to a network, it is strongly recommended to use Linksys® hubs or switches, which have undergone extensive compatibility testing with the Ethernet interface.

6.3.1 NETWORK SETUP USING DHCP SERVER

For this network setup to work, DHCP mode must be enabled. DHCP mode can be enabled using the front panel or the serial interface.

6.3.1.1 DHCP MODE SELECTION USING FRONT PANEL

a) To navigate to DHCP mode selection,

- Navigate to Home → Control Interface → LAN → LAN Configure.
- Enable both DHCP and Auto-IP as 'On' to use the DHCP mode of operation.

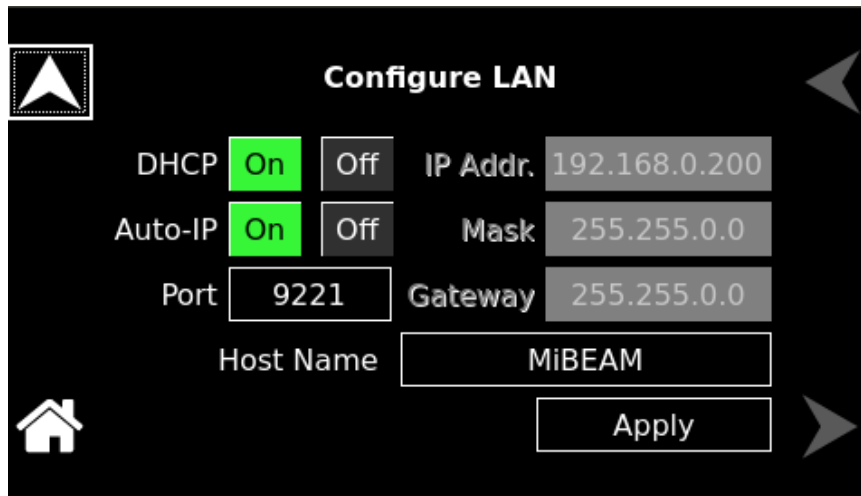

Figure 6-2: LAN Screen - Configure

NOTE: If DHCP server is not available and Auto-IP is enabled, the unit can assign itself an IP address in the Auto-IP (dynamic link local addressing) range.

NOTE: In DHCP mode of operation, if Auto-IP is 'OFF' and DHCP server is not available, the IP address will default to 192.168.0.3, refer to the Figure 6-3. This configuration is not usable for network connection.

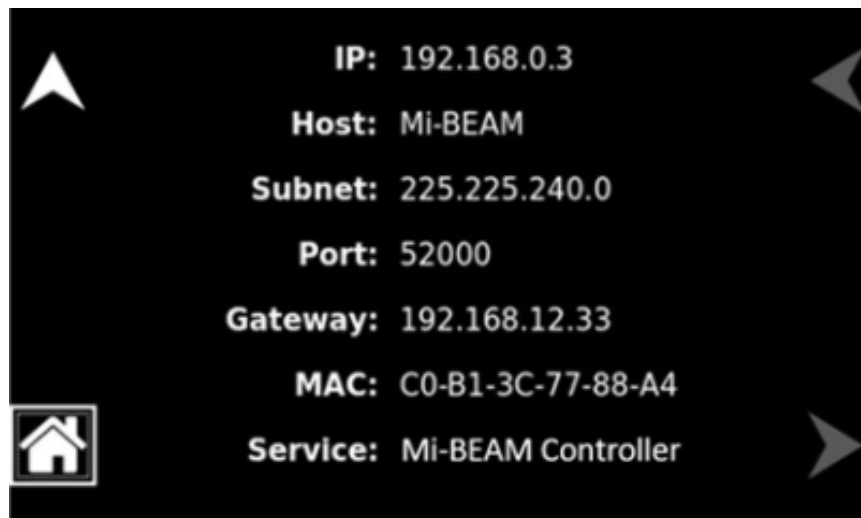

Figure 6-3. LAN Screen

6.3.1.2 DHCP MODE SELECTION USING SERIAL INTERFACE

- a) Connect using a computer serial communications program such as 'Tera Term' and establish communication as described in Section 4.2.2.
- b) Turn 'ON' DHCP mode using the SCPI command, 'SYST:NET:DHCPMODE 1'.
- c) Turn 'ON' AUTO-IP mode using the SCPI command, 'SYST:NET:AUTOIP 1'.
- d) Type SYST:NET:APPLY and press 'Enter' to apply the network settings.
- e) After configuring the settings, verify with the queries, 'SYST:NET:DHCPMODE?' and 'SYST:NET:AUTOIP?'.

6.3.1.3 IP ADDRESS IDENTIFICATION FOR DHCP MODE OF OPERATION

- a) Start with the power supply in the power-off state.
- b) Connect a RJ-45 network cable from the power supply to the network with the DHCP server.
- c) Power on the power supply and allow the power supply to perform its initialization.
- d) Identify the IP address assigned to the power supply by accessing the DHCP server, by any of four ways:
 - Asking your network administrator.
 - Discovering it with a VXI-11 compliant discover program.

NOTE: The power supply is VXI-11 compliant, so even without access to the DHCP server, it is still possible to discover the IP address assigned to the power supply with programs such as National Instrument's NI-VISA.

- e) Using the front panel and navigating to Home → Control Interface → LAN → LAN Settings. Refer to Figure 6-4.

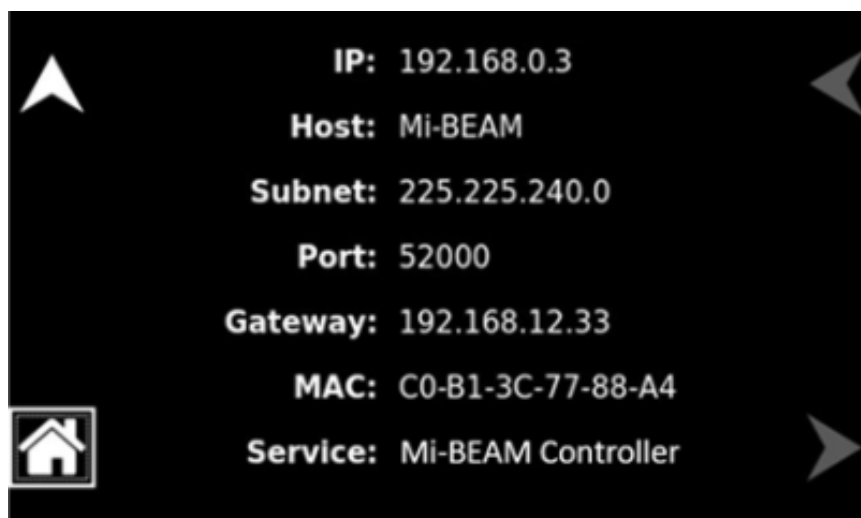

Figure 6-4: LAN Screen – Settings

- f) Using a computer serial communications program such as 'Tera Term', set for the same baud rate as Mi-Beam Series power supply, refer to Section 4.2.2, with no parity, 8 data bits, 1 stop bit. Use SCPI command 'SYST:NET:IP?' <Enter> to get the IP address.
- To find RS232 Settings of the power supply, navigate to Home → Control Interface → RS232 → RS232 Settings. Refer to Figure 6-5.



Figure 6-5: RS232 Screen - Settings

- g) The Mi-Beam power supply hardware is now configured. Open a web browser and enter the IP address of the power supply to view its Home page. Refer to Figure 6-12.

6.3.2 NETWORK SETUP USING AUTO-IP (DIRECT CONNECTION BETWEEN MI-BEAM POWER SUPPLY AND PC USING CROSS CABLE)

This setup requires that DHCP and Auto-IP is 'On', refer to Figure 6-2. DHCP and Auto-IP can be enabled using the front panel or the serial interface as described in the Section 6.3.1.1 and Section 6.3.1.2 respectively.

Since the setup is not connected to the DHCP server, the Mi-Beam Series power supply will assign itself an IP address in the range from 169.254.0.1 to 169.254.255 with a subnet mask of 255.255.0.0.

6.3.2.1 IP ADDRESS IDENTIFICATION FOR AUTO-IP MODE OF OPERATION

- a) Start with the power supply in the power-off state.
- b) Connect a crossover cable from the Mi-Beam Series power supply directly to your PC.
- c) If the PC is already configured to obtain an IP address automatically, skip to Step 'd'.

OR:

- In Windows,
 - **Start → Settings → Control Panel.**
 - Click open '**Network Connections**'.
 - In the '**Network Connections**' window, right click the icon for the '**network adapter**' used to connect to the power supply and click '**Properties**'.
 - Find the '**TCP/IP**' protocol item under the '**Configuration**' tab and click '**Properties**'. Select '**Obtain an IP Address Automatically**'.
 - Click '**OK**' to save the change.
 - Click '**OK**' again to apply the settings to the network adapter.
- d) In Windows, click '**Start**', and then '**Run**'.
- e) In the Run window, type '**ipconfig /release**' and click '**OK**'.
- f) Again, click '**Start**', and then '**Run**'.
- g) In the Run window, type '**ipconfig /renew**' and click '**OK**'. Your PC will assign itself an IP address in the Auto-IP range.
- h) '**Power ON**' the power supply and allow the power supply to perform its initialization.
- i) Identify the IP address assigned to the power supply, refer to Section 6.3.1.3.
- j) The Mi-Beam power supply Ethernet hardware is now configured. Open Web browser and enter the IP address of the power supply to view the Home page of the power supply. Refer to Figure 6-12.

6.3.3 NETWORK SETUP USING STATIC IP

This setup requires that DHCP is 'OFF'. DHCP mode can be turned 'OFF' using the front panel or the serial interface.

6.3.3.1 STATIC IP SETUP USING FRONT PANEL

- a) Navigate to **Home → Control Interface → LAN → LAN Configure**.
- b) Set DHCP to '**OFF**', refer to Figure 6-6. IP address button will be enabled.

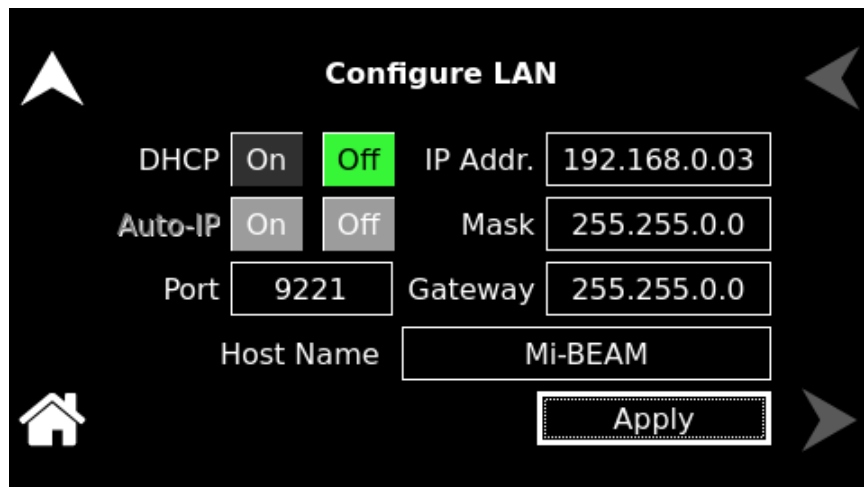

Figure 6-6. LAN configure - Settings

- c) Upon clicking the 'IP Address', 'Subnet Mask' and 'Gateway Address', numeric keypad to enter the IP address, Subnet Mask and Gateway Address will pop-up. Refer to Figure 6-7 to Figure 6-9.

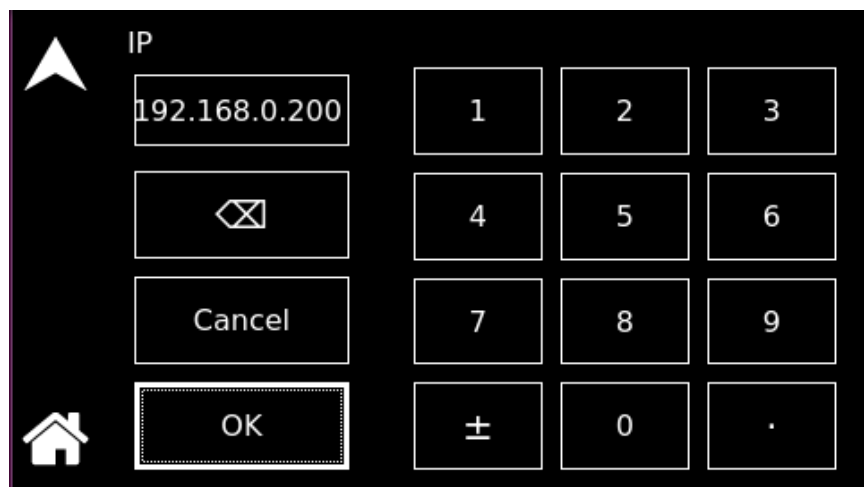

Figure 6-7. LAN Screen - Configure Static IP

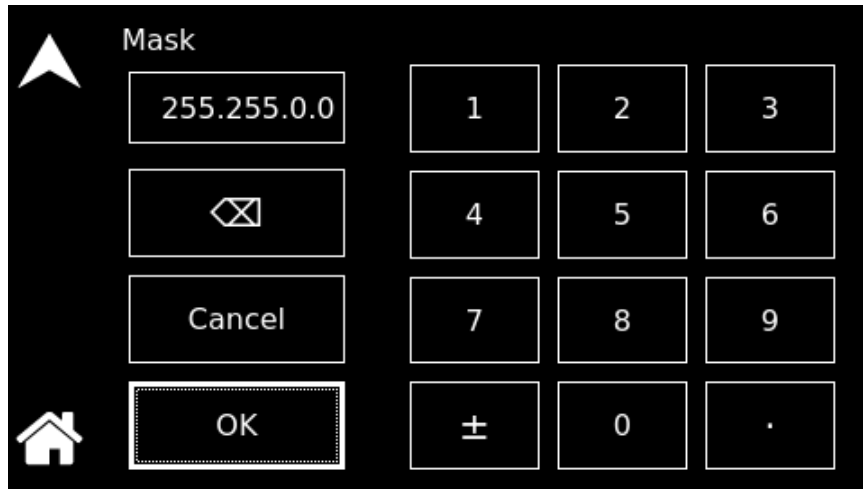

Figure 6-8. LAN Screen - Subnet Mask



Figure 6-9. LAN Screen - Gateway Address

- d) Enter the required IP address, Subnet mask and Gateway address. Refer to Figure 6-7 to Figure 6-9.
- e) Click '**Apply Now**' button for the settings to take effect.
- f) The Mi-Beam Series power supply's Ethernet hardware is now configured. Open Web browser and enter the IP address of the power supply to view the Home page. Refer to Figure 6-12.

6.3.3.2 STATIC IP SETUP USING THE SERIAL INTERFACE

- a) Connect using a computer serial communications program such as 'Tera Term', set to the same baud rate as the Mi-Beam Series power supply, refer to **Figure 6-5**, with no parity, 8 data bits, and 1 stop bit. Refer to Section 4.2.2.
- b) Turn '**OFF**' DHCP mode using the SCPI command, '`SYST:NET:DHCPMODE 0`'.

c) Set the IP address by typing 'SYST:NET:IP' "**xxx.xxx.xxx.xxx**" <enter> (where **xxx.xxx.xxx.xxx** is the new IP address).

- **For Example:**

To set '**192.168.0.200**' as the IP address, type SYST:NET:IP "**192.168.0.200**" <enter>.

NOTE: The format requires a single space after 'SYST:NET:IP' and double quotes ("") around the IP address numbers.

d) Set the subnet mask with 'SYST:NET:MASK' **xxx.xxx.xxx.xxx** <enter>.

e) Set the gateway with 'SYST:NET:GATE' **xxx.xxx.xxx.xxx** <enter>.

f) Type 'SYST:NET:APPLY' <enter> to apply the Static IP configuration.

g) After configuring all settings, verify with the queries,

- SYST:NET:IP? <enter>, SYST:NET:GATE? <enter> and SYST:NET:MASK? <enter>.

h) The Mi-Beam Series power supply's Ethernet hardware is now configured. Open Web browser and enter the IP address of the power supply to view the Home page. Refer to Figure 6-12.

i) Programming/Communication Via Ethernet

j) With the Ethernet option, there are three basic methods to communicate with the power supply from a PC:

- Raw socket interface, sending delimited strings
- Application program that utilizes VXI-11 Discovery protocol
- Web browser

6.3.4 RAW SOCKET INTERFACE

The essential components of communicating via a raw socket interface are the socket number, IP address and command delimiter. The default values are '**Socket = 52000**', '**IP address = 192.168.0.200**' (when DHCP is disabled), and '**Delimiter = line feed <CRLF>**'. We can set the static IP address, Subnet Mask and Gateway using web browser (refer to Section 6.4.2) or the RS232 interface.

For convenience and to comply with the proposed **LXI**TM standard, the VISA resource name is available on the home page of the power supply's Web server.

6.3.5 VXI-11 PROTOCOL

With programs such as National Instrument's NI-VISA, the VXI-11 protocol allows the power supply to be easily configured in a test system.

6.3.6 WEB SERVER

To communicate with the power supply via the built-in Web server, open a Web browser and type the IP address of the power supply in the '**Address**' field. Tap the enter key to launch the power

supply's Ethernet Web page interface.

6.4 ETHERNET WEB PAGES, OVERVIEW

The layout of each of the Web pages includes the banner showing the Manufacturer (AMETEK Programmable Power), AMETEK Logo and the Device name (e.g. LXI--AUX). Below the Mi-Beam Series power supply banner are four tabs, each linked to its corresponding page. Refer to Figure 6-10.

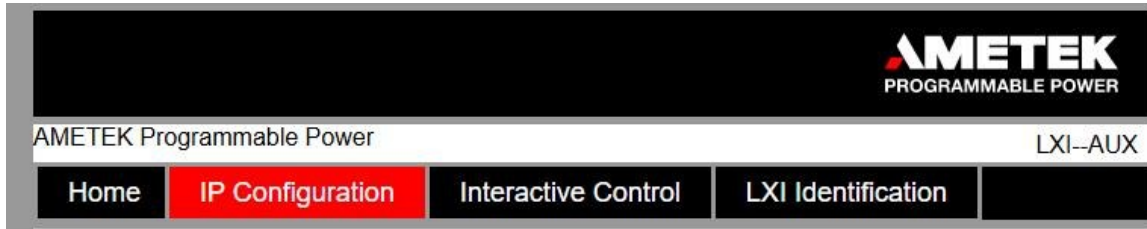

Figure 6-10. Mi-BEAM Series power supply Banner and Tab

When navigating to the Ethernet Web pages by clicking their tabs, you will find that the HOME page (default), Interactive Control and LXI Identification can be accessed without logging in. User must enter 'User ID' and 'Password'. For default values, refer to Section 6.2.1 and for accessing the IP Configuration Tab. Refer to Figure 6-11.

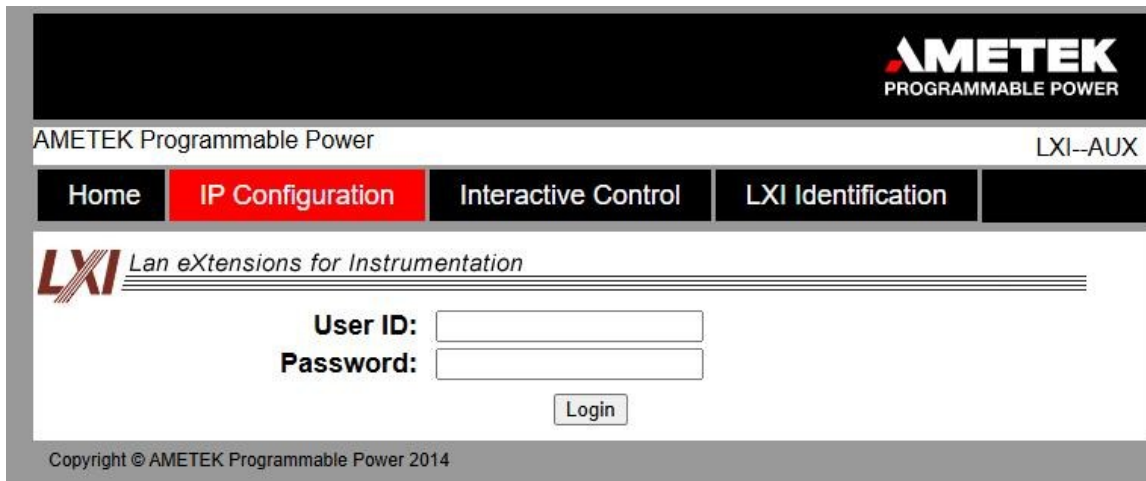

Figure 6-11. Login Window

6.4.1 HOME

This is the default, information-only page, refer to Figure 6-12. It displays all the current information about the power supply that you are connected to;

The screenshot shows the AMETEK Programmable Power LXI-AUX Home page. The page has a navigation bar with 'Home' selected. Below the navigation bar, the LXI logo and tagline 'Lan eXtensions for Instrumentation' are displayed. The main content area lists the following information:

- Model:**
- Manufacturer:** AMETEK Programmable Power
- Serial Number:** AUX
- VISA Resource:**
 - TCPIP0::10.221.4.66::inst0::INSTR
 - TCPIP0::10.221.4.66::9221::SOCKET
- LXI Version:** 1.5 LXI Device Specification 2016
- Host Name:** Mi-BEAM-100.local
- Description:** Mi-BEAM Controller (109)
- MAC Address:** 00:06:D0:00:C5:4F
- TCP/IP Address:** 10.221.4.66
- Subnet Mask:** 255.255.240.0
- Gateway:** 10.221.0.1
- Firmware Version:** 5.040
- Device Identify:**

Copyright © AMETEK Programmable Power 2014

Figure 6-12. Mi-Beam Series power supply Home Page

- The **'Model'** number, the **'Manufacturer'**, and the **'Serial Number'** of your Mi-Beam Series power supply.
- VISA Resource:** Identifies the specific resource name used to communicate via VISA (Virtual Instrument Software Architecture).
- LXI Version:** The version and instrument class of the **LXI™** standard with which your power supply is compliant.
- Host Name:** Either the default or user-defined, network-unique identity (Must be limited to 15 characters or less for LXI compliance).
- Description:** Either the default or user-defined description of the power supply in use.
- MAC Address:** the power supply Ethernet's unique hardware address.
- TCP/IP Address:** The power supply's address in use at start-up; can be statically configured, DHCP acquired (default), or Auto-IP assigned. Refer to Section 6.4.2.
- Subnet Mask:** Network segment when the power supply is 'On'.

- i) **Gateway:** IP address through which the instrument communicates with systems that are not on the local subnet.
- j) **Firmware Version:** The version of the firmware that is currently installed.
- k) **Device Identify:** When set button is pressed, the following screen will appear on the front panel screen of the power supply. Refer to Figure 6-13.

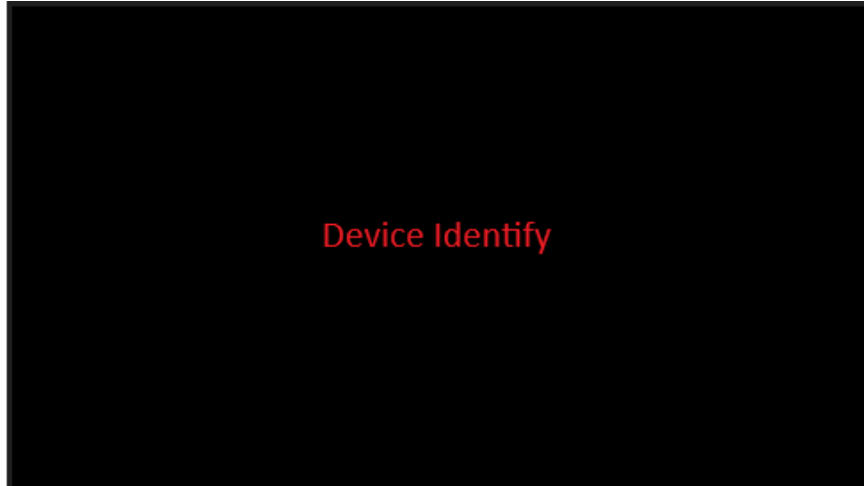
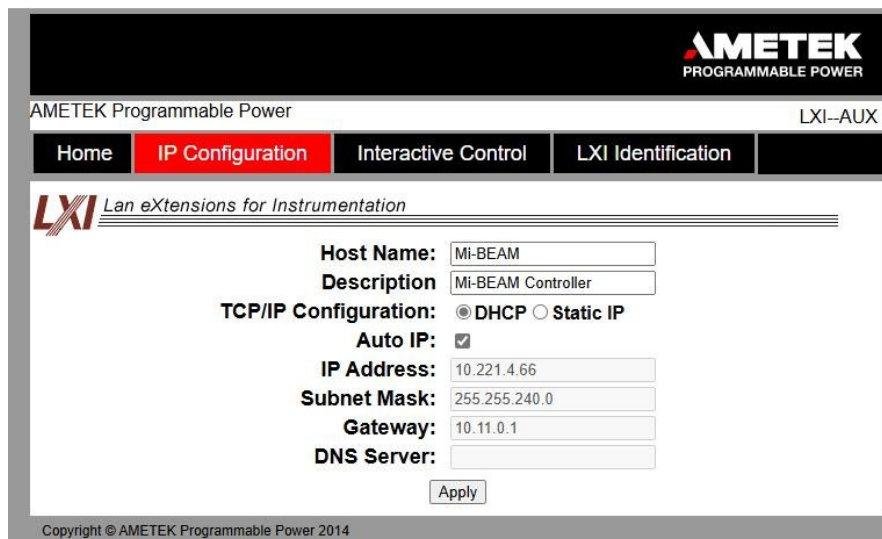

Figure 6-13. Mi-Beam Series power supply Device identify screen

6.4.2 IP CONFIGURATION

To access this web page, users need to login using the 'User ID' and 'Password'. For default values, refer to Section 6.2.1. Users are only required to complete the information for the parameters that need to be changed; all previously entered and saved information remains by default. Refer to Figure 6-14.



AMETEK Programmable Power LXI-AUX

Home IP Configuration Interactive Control LXI Identification

LXI Lan eXtensions for Instrumentation

Host Name:

Description:

TCP/IP Configuration: DHCP Static IP

Auto IP:

IP Address:

Subnet Mask:

Gateway:

DNS Server:

Copyright © AMETEK Programmable Power 2014

Figure 6-14. IP Configuration Page

a) **Host Name:** The default host name is '**Mi-BEAM**'.

NOTE: Users may change this name if it is unique (Host Name must be limited to 15 characters for LXI compliance) so that VXI-11 Discovery and any other IP Discovery program can identify the specific device on the network.

- **To change:** Type the new name (15 characters maximum) in the corresponding field provided and click '**Apply**' to update (or make all desired changes before clicking '**Apply**').

b) **Description:** User may change the default factory setting to something more meaningful to the current setup.

- To change: Type your customized description, up to 36 characters, in the corresponding field provided, and click '**Apply**' to update (or make all desired changes before clicking '**Apply**').

c) **TCP/IP Configuration:** The power supply can operate in DHCP or Static IP Configuration.

NOTE: User may statically assign an IP address as well as configure other Ethernet/LAN parameters (Subnet Mask and Gateway) or use DHCP for automatic assignment of an IP address.

d) **Static IP Configuration:** Click the radio button next to Static IP to manually configure some or all the following Ethernet/LAN parameters:

- **IP Address** – Input any standard IP address. (Factory setting is 192.168.0.3). Click '**Apply**' and enter the new IP address in LXI web browser to view the Home page of the power supply, refer to Figure 6-12. If the user have changed the network portion of the IP address, it may be necessary to alter the network settings of your attached computer to reconnect to the power supply.
- **Subnet Mask** – Input a value that identifies which network segment your power supply is on, consisting of 4 whole numbers, each ranging from 0 through 255, separated by periods. (Factory setting is 255.0.0.0, a class-C network subnet mask). Click '**Apply**' to update (or make all desired changes before clicking '**Apply**').
- **Gateway** – Input the IP Address of any gateway that stands between the instrument and any other network entities that communicate with the power supply (No factory setting). Click '**Apply**' to update (or make all desired changes before clicking '**Apply**').

e) **DHCP Configuration** – Click the radio button next to DHCP, for dynamic address acquisition from the DHCP server.

f) **Auto IP** – If it is enabled, when there is no DHCP server available, the power supply will assign itself an IP address a subnet mask of 255.255.0.0.

- Click in the box next to Auto IP to check (enable Auto IP) and click again to uncheck (disable Auto IP). Refer to Figure 6-14.

6.4.3 INTERACTIVE CONTROL

This web page allows to input a properly formatted SCPI command, refer to Chapter 9. Click on Send Command button to send the command to the power supply. The commands and response to the query command can be seen on the web page. Refer to Figure 6-15.

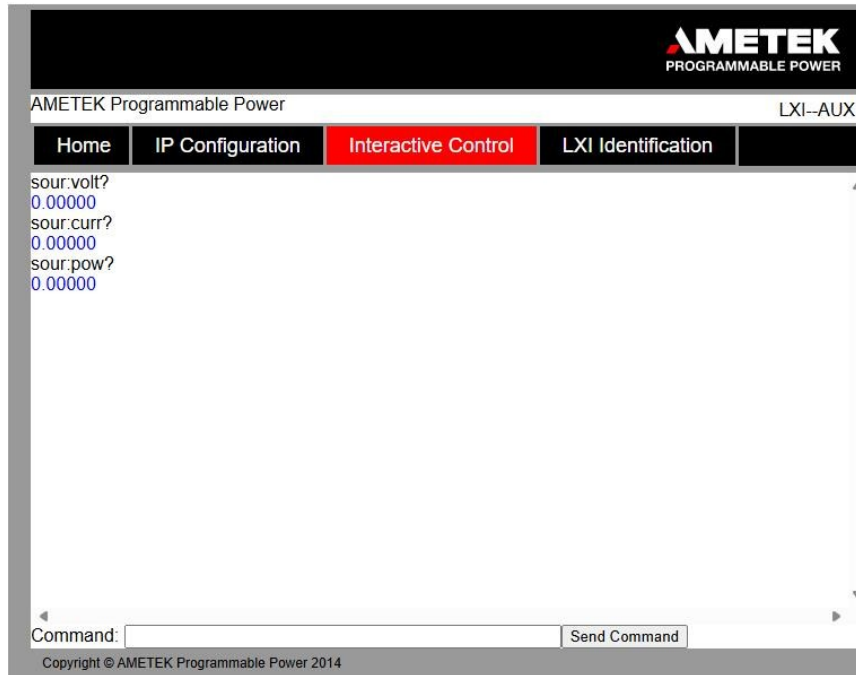

Figure 6-15. Interactive Control Page

6.4.4 LXI IDENTIFICATION

The LXI Identification web page displays the LXI parameters of the Mi-Beam Series power supply. Refer to Figure 6-16.

The screenshot shows the LXI Identification page of the AMETEK Programmable Power web interface. The page has a black header with the AMETEK logo and 'PROGRAMMABLE POWER' text. Below the header, the text 'AMETEK Programmable Power' is on the left and 'LXI--AUX' is on the right. A navigation bar contains four buttons: 'Home', 'IP Configuration', 'Interactive Control', and 'LXI Identification' (which is highlighted in red). Below the navigation bar is the LXI logo and the text 'LXI Lan eXtensions for Instrumentation'. The main content area lists various system parameters:

Model:
Manufacturer: AMETEK Programmable Power
Serial Number: AUX

VISA Resource:

- TCPIP0::10.221.4.66::inst0::INSTR
- TCPIP0::10.221.4.66::9221::SOCKET

LXI Version: 1.5 LXI Device Specification 2016
Host Name: Mi-BEAM-100.local
Description: Mi-BEAM Controller (109)
MAC Address: 00:06:D0:00:C5:4F
TCP/IP Address: 10.221.4.66
Subnet Mask: 255.255.240.0
Gateway: 10.221.0.1
DHCP Enabled: true
AutoIP Enabled: true
Identification URL: <http://10.221.4.66/lxi/identification>
Firmware Revision: 5.040

Copyright © AMETEK Programmable Power 2014

Figure 6-16. LXI Identification Page

7

IEEE 488.2 GPIB CONFIGURATIONS AND REMOTE PROGRAMMING

7.1 REAR PANEL

This section provides an illustration of the Mi-BEAM Series power supply's rear panel layout, refer to Figure 7-1. Regardless of the layout, the component functions are common across all models, and those relevant to the IEEE 488.2 GPIB(Optional) options are described here.

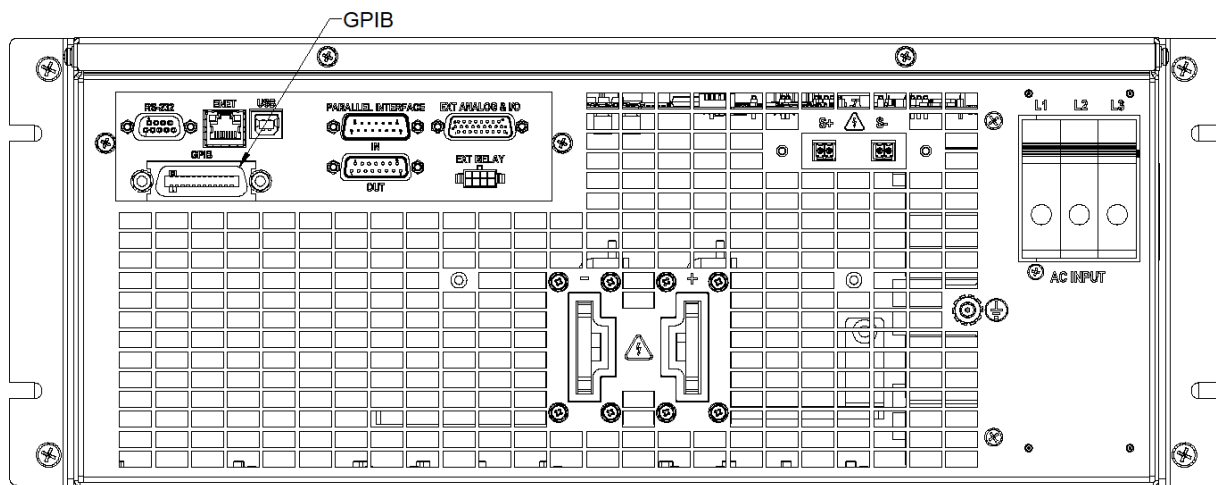

Figure 7-1. Rear Panel – IEEE 488.2 GPIB Interface

7.2 REMOTE PROGRAMMING VIA IEEE 488.2 GPIB CONNECTOR

7.2.1 ADDRESS SELECTION

The GPIB address for the unit can be set from '1 to 30'. SCPI reserves channel '0' as the global channel to address all channels. The Mi-Beam power supply's GPIB address can be configured using the front panel menu, refer to Figure 7-2.

- a) To navigate to GPIB screen,
 - Go to Home → Control Interface → GPIB.

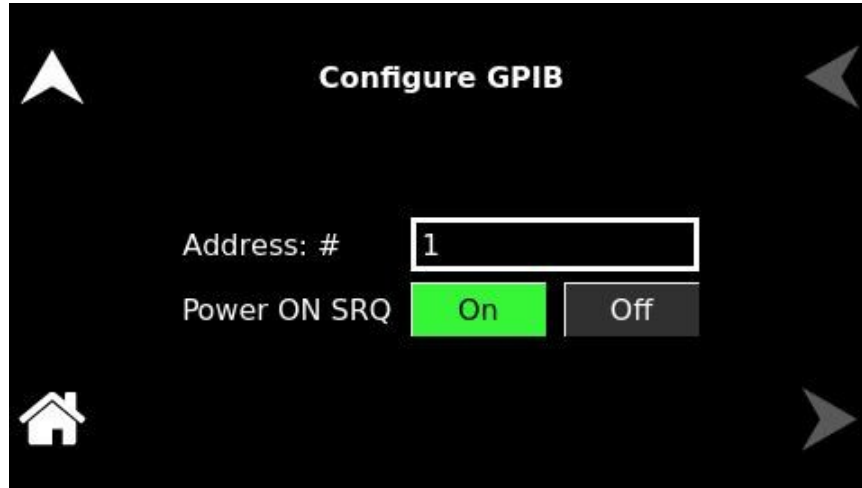

Figure 7-2: GPIB Screen

7.2.2 POWER-ON GPIB SERVICE REQUEST (PON SRQ) SELECTION

PON SRQ can be enabled using the front panel menu, refer to Figure 7-2. When PON SRQ is enabled, a GPIB service request will be sent by the power supply to the computer controller upon Power ON.

7.2.3 SHIELD GROUND

Connects GPIB cable shield to chassis ground.

7.2.4 IEEE 488.2 GPIB SETUP PROCEDURE

- a) Set the GPIB address via the front panel menu, Refer to Figure 7-2.
- b) Connect GPIB cable from the controlling computer to the Mi-Beam Series power supply.
NOTE: If operating in an inherently noisy environment, such as high RF or other radiated emissions, a double-shielded GPIB cable is recommended.
- c) Connect power to the unit and turn on the unit.
- d) Using a GPIB communication software, test the communication interface by issuing the '*IDN?' Command. This returns the supply's model, serial numbers, and software version(s). This command does not affect the output of the supply.

This page intentionally left blank

8

REMOTE ANALOG PROGRAMMING AND EXTERNAL USER INTERFACES

8.1 REAR PANEL

This section provides illustrations of the MI-BEAM Series power supply's rear panel layout. Refer to Figure 8-1, regardless of the layout, the component functions are common across all models and those that are pertinent to the Remote Analog Programming and external user Interface Connector is described here. The analog programming functionality can be exercised from either of the communication interfaces (RS232, USB, Ethernet and IEEE 488.2 GPIB).

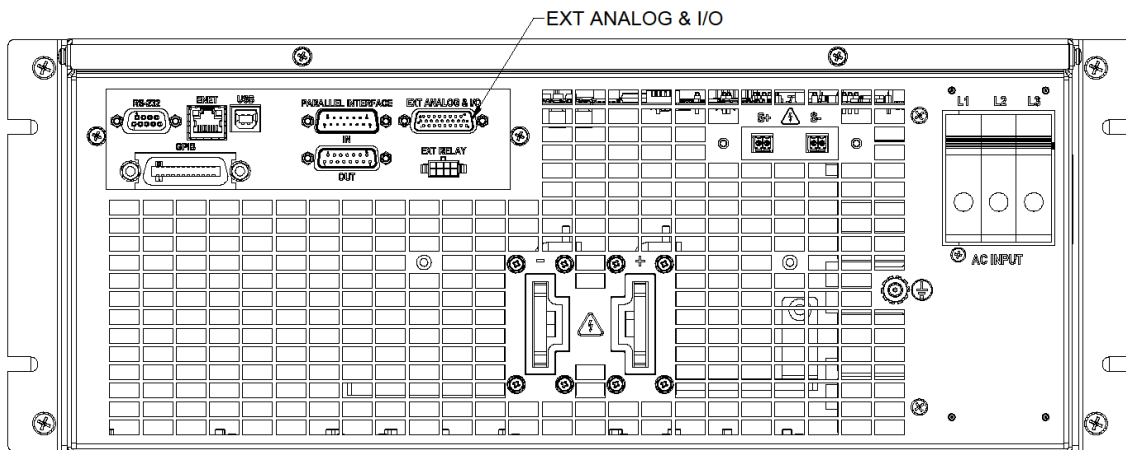

Figure 8-1: Rear Panel – External Analog

8.2 REAR PANEL USER INTERFACE CONNECTORS

The rear panel contains the connectors for the remote analog and discrete-digital control interfaces, the digital communications interfaces (LAN, USB and RS-232 and optional GPIB IEEE-488), and the external interface.

8.2.1 REMOTE EXTERNAL USER CONTROL INTERFACE

The Remote External user control interface is located on the rear panel. Figure 8-2 shows the rear panel view of the connector, and Table 8-1 lists the connector type. Table 8-2 shows the functions and Table 8-3 shows the connector pinout.

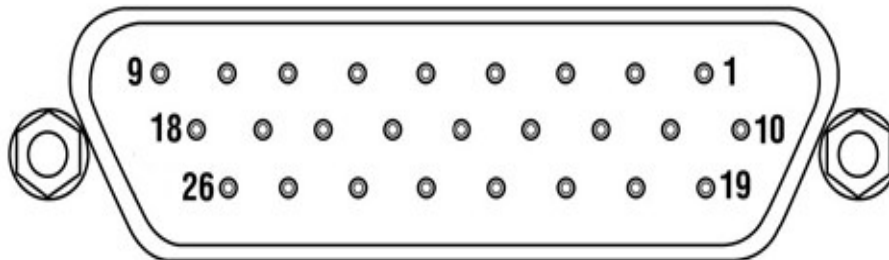

Figure 8-2. External User Control Interface connector

CONNECTOR	TYPE
Remote External User Control Interface	High-density, 26-contact, female D-Type, Norcomp P/N 181-026-213R531 Mating connector, Norcomp P/N 180-026-103L001

Table 8-1: External User Control Interface connector Type

REMOTE ISOLATED EXTERNAL USER CONTROL I/O SIGNAL INTERFACE	
FUNCTION	CHARACTERISTICS
Remote Inhibit Input – Contact Closure - Open	Opening the Switch or Relay contact between this terminal and signal return will turn OFF the output. Switch or Relay closure or direct short from this terminal to signal return would turn-on the output. Remote inhibit can be configured in three modes; a) Latch: after reclosing the contact, user needs to clear the fault and turn ON the output. b) Live: after reclosing the contact, user can turn ON the output. c) OFF: inhibit function would be disabled. Remote circuit must sink up to 10 milliampere (mA) from 5 volts direct current (VDC) to enable.
Remote Inhibit Input – Contact Closure - Close	Closing the Switch or Relay contact between this terminal and signal return will turn OFF the output. Switch or Relay opening would turn ON the output. Remote inhibit can be configured in three modes; a) Latch: after reclosing the contact, user can clear the fault and turn ON the output. b) Live: after reclosing the contact, user needs to turn ON the output.

REMOTE ISOLATED EXTERNAL USER CONTROL I/O SIGNAL INTERFACE	
FUNCTION	CHARACTERISTICS
	<p>c) OFF: inhibit function would be disabled.</p> <p>Remote circuit must sink up to 10 mA from 5 VDC to enable.</p>
Remote Inhibit Input – Active Source – High	<p>An active voltage source high signal from this terminal to signal return will Turn OFF the output of power supply.</p> <p>Remote inhibit can be configured in three modes;</p> <p>a) Latch: after removing the active voltage source, user can clear the fault and turn ON the output.</p> <p>b) Live: after removing the active voltage source, user can turn ON the output.</p> <p>c) OFF: inhibit function would be disabled.</p> <p>Remote circuit must sink up to 10 mA from 5 VDC to enable.</p>
Remote Inhibit Input – Active Source – Low	<p>An active voltage source low signal from this terminal to signal return will Turn OFF the output of power supply.</p> <p>Remote inhibit can be configured in three modes;</p> <p>a) Latch: after removing the active voltage source low signal, user needs to clear the fault and turn ON the output.</p> <p>b) Live: after removing the active voltage source, user can turn ON the output.</p> <p>c) OFF: inhibit function would be disabled.</p> <p>Remote circuit must sink up to 10 mA from 5 VDC to enable.</p>
Trigger In ⁽¹⁾	<p>TTL compatible Input signal, active-high pulse of 100 μs; detects external hardware trigger at falling edge of the pulse for voltage, current ramp and Transient List functions. Signal connects to Open-anode of opto-isolator diode with internal 1 kΩ series resistor internal to power supply.</p> <p>Voltage Rating: Maximum 24 V, Minimum -5 V</p> <p>Low state: 0.3 V max, High State 2.7 V min</p>
Trigger Out ⁽¹⁾	<p>Output signal, active-high; synchronization pulse of 100 μs.</p> <p>Open collector transistor output, Collector is connected to the 26-pin connector. The emitter point of transistor is connected to common return pin of the interface connector.</p> <p>Voltage Rating: Maximum 30 V, Minimum 3 V for Active High, Current Sink Current: 50 mA</p>
CC/CV status Output	<p>Output signal, High state indicates Constant Current mode operation and Low state indicates Constant Voltage mode operation.</p> <p>Open collector transistor output, Collector is connected to the 26-pin connector. The emitter point of transistor is connected to common return pin of the interface connector.</p>

REMOTE ISOLATED EXTERNAL USER CONTROL I/O SIGNAL INTERFACE	
FUNCTION	CHARACTERISTICS
	Voltage Rating: Maximum 30 V, Minimum 3 V for Active High, Current Sink Current: 50 mA
Output ON/OFF Status	Output signal, High state indicates Output is ON and Low state indicates Output is OFF. Open collector transistor output, Collector is connected to the 26-pin connector. The emitter point of transistor is connected to the common return pin of the interface connector. Voltage Rating: Maximum 30 V, Minimum 3 V for Active High, Sink Current: 50 mA
FAULT Status	Output Signal, High state indicates fault state of the power supply. Open collector transistor output, Collector is connected to the 26-pin connector. The emitter point of transistor is connected to the common return pin of the interface connector. Voltage Rating: Maximum 30 V, Minimum 3 V for Active High, Current Sink Current: 50 mA
ISOLATED ANALOG PROGRAMMING FEATURES	
Remote Analog Programming of Output Voltage ⁽¹⁾	Independent Signal inputs for output voltage programming using External Analog Reference. Analog reference source is user selectable and can be a voltage or resistance. User can select the reference source and range as given below; <ul style="list-style-type: none"> a) Voltage as Reference Source: 0 V to user selectable maximum range (5 V to 10 V) for 0 to full scale rated Output. b) Resistance as Reference Source: 0 Ω to user selectable maximum range (5 kΩ to 10 kΩ) for 0 to full scale rated Output. Programming accuracy and linearity: $\pm 1\%$ of rated output
Remote Analog Programming of Output Current ⁽²⁾	Independent Signal inputs for output current programming using External Analog Reference. Analog reference source is user selectable and can be a voltage or resistance. User can select the reference source and range as given below; <ul style="list-style-type: none"> a) Voltage as Reference Source: User selectable range of (-5 V to +5 V) or (-10 V to +10 V) for 0 to full scale rated Output. b) Resistance as Reference Source: 0 Ω to user selectable maximum range (5 kΩ to 10 kΩ) for 0 to full scale rated Output. This is applicable only in source mode. Programming accuracy and linearity: $\pm 1\%$ of rated output
Monitor Signals for the Output Voltage and Output Current	Monitor Signals for the Output Voltage and Current. Full Scale range: 0 V to 10 V corresponds to 0-100% full-scale output. Minimum recommended Load: 100 k Ω , typical Maximum Load: 20 k Ω

REMOTE ISOLATED EXTERNAL USER CONTROL I/O SIGNAL INTERFACE	
FUNCTION	CHARACTERISTICS
	Monitor accuracy and linearity: $\pm 1\%$ of full-scale output
Remote Analog Programming of Overvoltage ⁽²⁾	Signal input for setting Overvoltage using External Analog Reference Voltage. Range: 0.25 V to user selectable maximum range (5 V to 10 V) for 5% to 110% of the full-scale Output Voltage. Programming accuracy and linearity: $\pm 1\%$ of full-scale output.
⁽¹⁾ Trigger IN and Trigger OUT signals can be used during Ramp and Transient List functionality only.	
⁽²⁾ Unit can be operated in remote analog programming in Bi-directional, Source and Eload modes only.	

Table 8-2: External User Control Interface Characteristics

PIN	REFERENCE	TYPE	RANGE	FUNCTIONAL DESCRIPTION
1	VPRG_VOLT	Input	0-10V	Independent Signal inputs for output voltage programming using External Analog Reference. In this, the reference is a voltage source: 0 V to user selectable maximum range (5 V to 10 V) for 0 to full scale rated output voltage.
2	VPRG_CURR	Input	0 - 10 kOhm	Independent Signal inputs for output voltage programming using External Analog Reference. In this, the reference is resistance source: 0 Ohm to user selectable maximum range (5 kOhm to 10 kOhm) for 0 to full scale rated output voltage.
3	IPRG_VOLT	Input	-10 to +10V	Independent Signal inputs for output current programming using External Analog Reference. In this, the reference is a voltage source: -10 V to +10 V for 0 to full scale rated output current.
4	IPRG_CURR	Input	0 - 10 kOhm	Independent Signal inputs for output current programming using External Analog Reference. In this, the reference is resistance source: 0 Ohm to user selectable maximum range (5 kOhm to 10 kOhm) for 0 to full scale rated output current (available only in Source mode).



PIN	REFERENCE	TYPE	RANGE	FUNCTIONAL DESCRIPTION
5	OVPRG_VOLT	Input	0-10V	Remote Analog Programming of Overvoltage. Signal input for setting Overvoltage using External Analog Reference Voltage. 0.25 V to user selectable maximum range (2 V to 10 V) for 5% to 110% of the full-scale Output Voltage.
6	GND_ISOSELV	Return	NA	Ground for programming Signals
7	VMON	Output	0-10V	Monitor Signals for the Output Voltage
8	IMON	Output	-10 to +10V	Monitor Signals for the Output Current.
9	GND_ISOSELV	Return	NA	Ground for Monitor Signals
10	DIO_OUT1	Output	0-30 V	Open collector transistor output for user programming
11	DIO_OUT2	Output	0-30 V	Open collector transistor output for user programming
12	SOUR/SINK_OUT	Output	0-30 V	Open collector transistor output. Collector is connected to the 26-pin connector. Status signal to communicate the direction of current flow. Low – indicates power transfer is from power supply to UUT. High – indicates power transfer is from UUT to Power supply.
13	TRIG_OUT	Output	0-30 V	Open collector transistor output. Collector is connected to the 26-pin connector. Emitter point of transistor is connected to common return pin of the interface connector. Active-high; synchronization pulse of 100 μ s.
14	DIO_ON/OFF_STAT	Output	0-30 V	ON/OFF-Open collector transistor output, Collector is connected to the 26-pin connector. Emitter point of transistor is connected to common return pin of the interface connector. High state indicates

PIN	REFERENCE	TYPE	RANGE	FUNCTIONAL DESCRIPTION
				Output is ON and Low state indicates Output is OFF
15	DIO_CC/CV_OUT	Output	0-30 V	CC/CV status- open collector configuration. Collector is connected to the 26-pin connector. Emitter point of transistor is connected to common return pin of the interface connector. High state indicates Constant Current mode operation and Low state indicates Constant Voltage mode operation.
16	DIO_FAULT_OUT	Output	0-30 V	Fault status- open collector configuration. Collector is connected to the 26-pin connector. Emitter point of transistor is connected to common return pin of the interface connector. High state indicates fault state of the power supply
17	RTN	Return	NA	Return for digital signals
18	RTN	Return	NA	Return for digital signals
19	TRIG_IN	Input	0 to 24 V	TTL compatible Input signal, active-high pulse of 100 μ s; detects external hardware trigger at falling edge of the pulse for voltage, current ramp, and Transient List functions. Signal connects to Open-anode of opto-isolator diode with internal 1k Ω series resistor internal to power supply.
20	DIO_OUTPUT_ON/OFF	Input	0 to 24 V	Remote-control input for output on/off with a logic signal: a logic-high, 2.7-24 VDC TTL/CMOS signals will enable (turn-on) the output of the supply, and a logic-low signal disables (turns off) the output
21	Digital_IN-1	Input	-5 to 24 V	Remote-control input with a logic signal
22	Digital_IN-2	Input	-5 to 24 V	Remote-control input with a logic signal

PIN	REFERENCE	TYPE	RANGE	FUNCTIONAL DESCRIPTION
23	Digital_IN-3	Input	-5 to 24 V	Remote-control input with a logic signal
24	Remote_Inhibit_Active_Voltage	Input	-5 to 24 V	Remote-control input for output on/off with a logic signal
25	Remote_Inhibit_Contact_Closure	Input	-5 to 24 V	Switch/Relay contact closure or direct short from this terminal to signal return is required to Turn ON/OFF the power supply. Opening the contact would shut down the output.
26	RTN	Return	NA	Ground return

NOTE: All the signals are safety isolation SELV-rated, referenced to chassis.

Table 8-3: External User Control Interface Pin Out details

	<p>CAUTION! All the three channels signal returns (Pin 17, 18 and 26) are shorted internally. Applying a voltage potential between them would damage the power supply.</p>
	<p>CAUTION! External User Control interface signals are isolated from negative output terminal; Isolation voltage is rated for ± 600 VRMS, maximum; operation of Isolated Analog Interface signals should be at SELV safety voltage conditions to chassis ground.</p>

8.2.2 REMOTE INHIBIT SIGNAL

The Remote Inhibit signal, Pin-24 for Remote inhibit Active Voltage and Pin-25 for Remote inhibit Contact Closure, can be used to enable or disable the output of the power supply.

The following types can be selected:

- a) **Contact Closure:** The remote inhibit type can be set to 'Contact Closure' using SCPI command;

```
OUTP: REM: INHIBIT: TYPE 0
```

Contact closure has two remote inhibit states, it can be either 'OPEN' or 'CLOSE'

- **OPEN:** When the inhibit state is selected to 'OPEN', open path from this signal to the return signal shuts down the power supply output. The remote inhibit state can be set to 'Open' using SCPI command;

```
OUTP: REM: INHIBIT: STATE 0
```

- **CLOSE:** When the inhibit state is selected to 'CLOSE' a switch/relay contact closure or a direct short from this terminal to signal return shuts down the power supply output. The remote inhibit state can be set to 'Close' using SCPI command;

```
OUTP: REM: INHIBIT: STATE 1
```

b) Active Source: The remote inhibit type can be set to 'Active Source' using SCPI command;

```
OUTP: REM: INHIBIT: TYPE 1
```

Active source has two remote inhibit states, it can be either 'LOW' or 'HIGH'.

- **LOW:** When the inhibit state is selected to 'LOW' an active voltage source low from this terminal to signal return shuts down the power supply output. The remote inhibit state can be set to 'LOW' using SCPI command;

```
OUTP: REM: INHIBIT: STATE 0
```

- **HIGH:** When the inhibit state is selected to 'HIGH', an active voltage source high from this terminal to signal return shuts down the power supply output. The remote inhibit state can be set to 'HIGH' using SCPI command;

```
OUTP: REM: INHIBIT: STATE 1
```

The remote inhibit mode can be changed using SCPI command;

```
OUTP: REM: INHIBIT: MODE <mode>.
```

The default mode for Remote Inhibit is OFF.

a) LATCH: The Remote Inhibit input latches the output in the protection shutdown state. This state can only be cleared by the remote digital interface SCPI command, *CLS. The remote inhibit mode can be set to 'Latching' using SCPI command;

```
OUTP: REM: INHIBIT: MODE LATCHING.
```

b) LIVE: The output state follows the state of the Remote Inhibit input. The remote inhibit mode can be set to 'live' using SCPI command;

```
OUTP: REM: INHIBIT: MODE LIVE
```

c) OFF: The power supply ignores the Remote Inhibit input. The remote inhibit mode can be set to 'OFF' using SCPI command;

```
OUTP: REM: INHIBIT: MODE OFF
```

8.2.3 REMOTE ANALOG PROGRAMMING

The remote analog programming is located on the rear panel. Figure 8-2 shows the rear panel view of the connector, and Table 8-1 lists the connector type. Table 8-2 shows the functions and Table 8-3 shows the connector pinout.

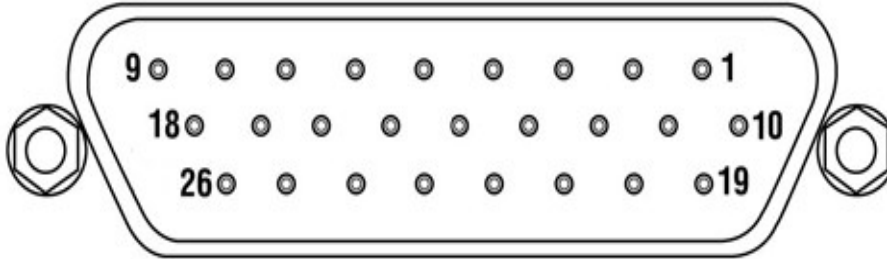

Figure 8-3. Analog Control connector

8.2.3.1 REMOTE VOLTAGE PROGRAMMING

Remote voltage programming configuration is used for applications that require the output voltage be programmed (controlled) from a remote instrument. An external resistance or external voltage source can be used as a programming device. When using remote voltage programming, a shielded, twisted-pair cable is recommended to prevent noise interference to programming signals.

a) Remote Voltage Programming by Voltage Source

Programs the output voltage of the supply by external voltage reference source. Refer to Control Interface chapter to configure the power supply to program output voltage by external reference source using front panel screen, refer to the operational manual P/N: M587351-01.

- Power supply configuration to program output voltage by voltage source:

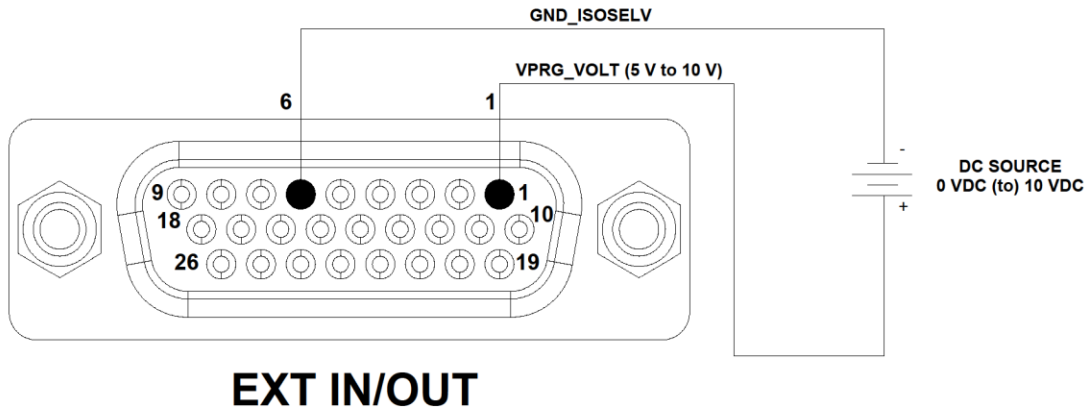

Figure 8-4. Remote Voltage Programming by Voltage source

The DC voltage source is connected between Pin 1 (VPRG_VOLT), ground Pin 6 (GND_ISOSELV) and the 'Analog Reference source' is selected as 'Voltage' from the front Panel.

The Full-Scale voltage value can be modified to any voltage between 5V to 10V from front panel screen or by the digital interface SCPI Command. Default FSC voltage value is 10V, where 10V corresponds to 100% output voltage. The corresponding voltage-programming coefficients for output voltage are 100% rated output voltage / FSC VDC. The equation for output voltage set from analog programming is as follows:

$$V_{out} = V_{dc} \times (100\% \text{ rated output voltage} / \text{FSC VDC}), \text{ with } V_{dc} \text{ in volts.}$$

b) Remote Over Voltage Programming by Voltage Source

Programs the output over voltage protection limit of the supply by external voltage reference source. Refer to Control Interface chapter to configure the power supply to program output overvoltage by external reference source using front panel screen, refer to the operational manual P/N: M587351-01.

- Power supply configuration to program output overvoltage by voltage source:

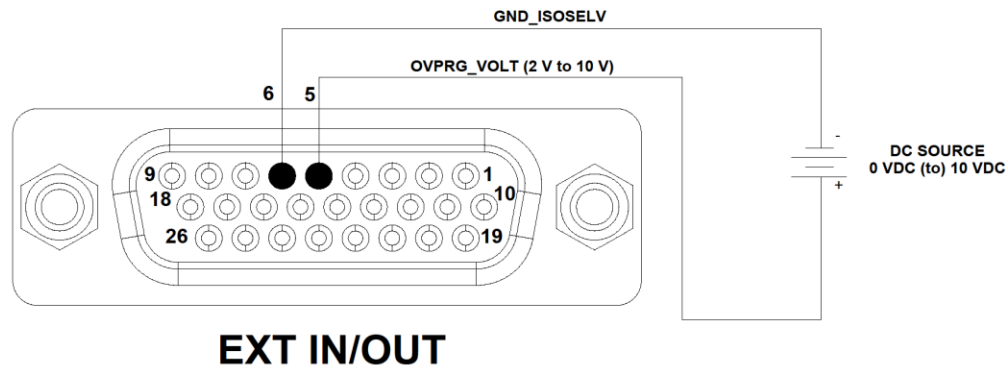

Figure 8-5. Remote Over Voltage Programming by Voltage source

The DC voltage source is connected between Pin 5 (OVRPG_VOLT), ground Pin 6 (GND_ISOSELV) and the 'Analog Reference source' is selected as 'Over Voltage' from the front Panel.

The Full-Scale voltage value for overvoltage programming can be modified to any voltage between 5 V to 10 V from the front panel screen or by using the digital interface SCPI Command. The default FSC voltage value is 10 V, where 10 V corresponds to 110% of the rated output voltage. The equation for overvoltage set from analog programming is as follows:

$$OVP = V_{dc} \times (110\% \text{ rated output voltage} / \text{FSC VDC}), \text{ with } V_{dc} \text{ in volts}$$

c) Remote Voltage Programming by Current Source

Programs the output voltage of the supply by current reference source. Refer to Control Interface chapter to configure the power supply to program output voltage by external reference source using front panel screen, refer to the operational manual P/N: M587351-01.

- **Power supply configurations to program output voltage by current source:**

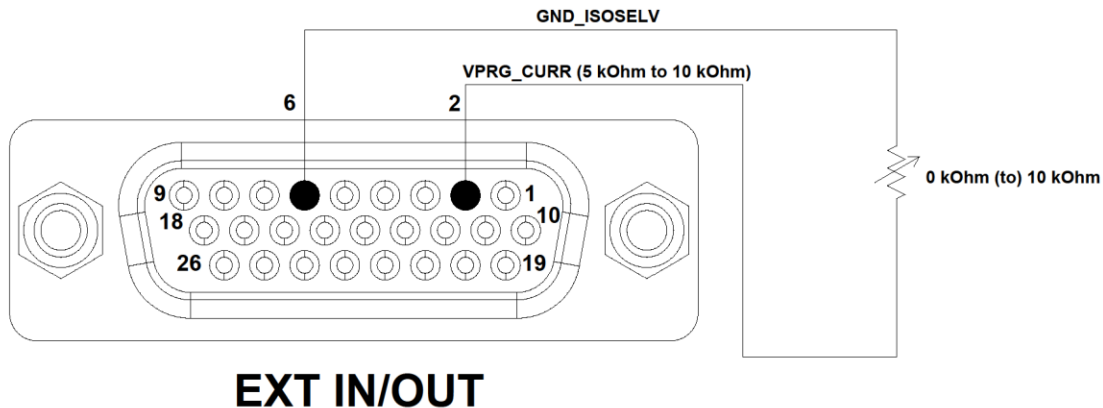

Figure 8-6. Remote Voltage Programming by Current Source

The programmable resistor is connected between Pin 2 (VPRG_CURR), ground Pin 6 (GND_ISOSELV) and the 'Analog Reference source' is selected as 'Current' from the front Panel.

The Full-Scale value for voltage programming can be modified to any value between 5 kΩ to 10 kΩ from the front panel screen or by using the digital interface SCPI Command. The default FSCR value is 10 kΩ, where 10 kΩ corresponds to 100% of the rated output voltage. The equation for voltage set from analog programming current source is as follows

$$V_{out} = R \times (100\% \text{ rated output voltage} / \text{FSC k}\Omega), \text{ with } R \text{ in kilo ohms.}$$

8.2.3.2 REMOTE CURRENT PROGRAMMING

Remote current programming is used for applications that require the output current be programmed (controlled) from a remote instrument. An external resistance or external voltage source can be used as a programming device. When using remote current programming, a shielded, twisted-pair cable is recommended to prevent noise interference to programming signals.

a) Remote Current Programming by Voltage Source

Programs the output current of the supply by external voltage reference source. Refer to Control Interface chapter to configure the power supply to program output current by external reference source using front panel screen, refer to the operational manual P/N: M587351-01.

- **Power supply configurations to program output current by voltage source:**

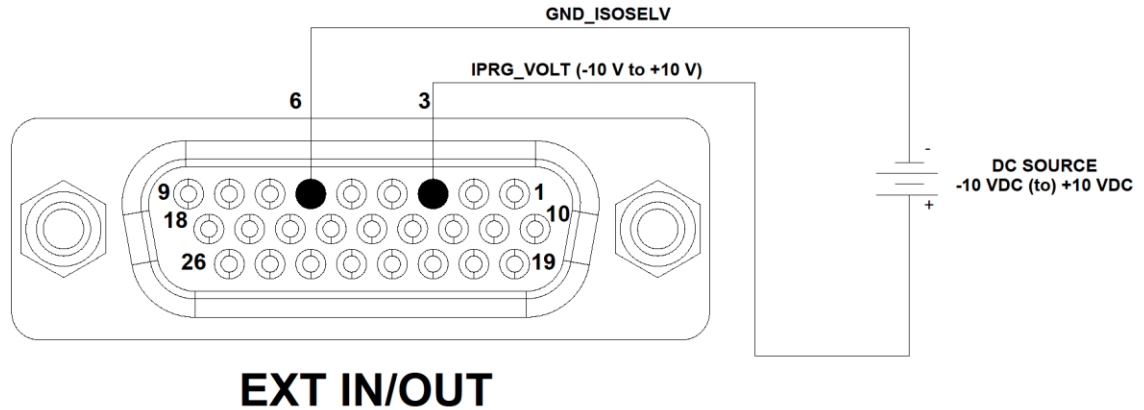

Figure 8-7. Remote Current Programming by Voltage Source

The DC voltage source is connected between Pin 3 (IPRG_VOLT), ground Pin 6 (GND_ISOSELV) and the 'Analog Reference source' is selected as 'Resistive' from the front Panel. Refer to Figure 8-7.

The Full-Scale voltage value can be modified to any voltage between 5V to 10V from front panel screen or by the digital interface SCPI Command. Default FSC voltage value is 10V, where 10V corresponds to 100% output current and -10V corresponds to -100% output current. The corresponding voltage-programming coefficients for output current are 100% rated output current / FSC VDC. This produces transfer functions for output current, as follows:

$$I_{out} = V_{dc} \times (100\% \text{ rated output current} / \text{FSC VDC}), \text{ with } V_{dc} \text{ in volts.}$$

b) Remote Current Programming by Current Source

Programs the output current of the supply by external current reference source. Refer to Control Interface chapter to configure the power supply to program output current by external reference source using front panel screen, refer to the operational manual P/N: M587351-01.

- **Power supply configurations to program output current by current source:**

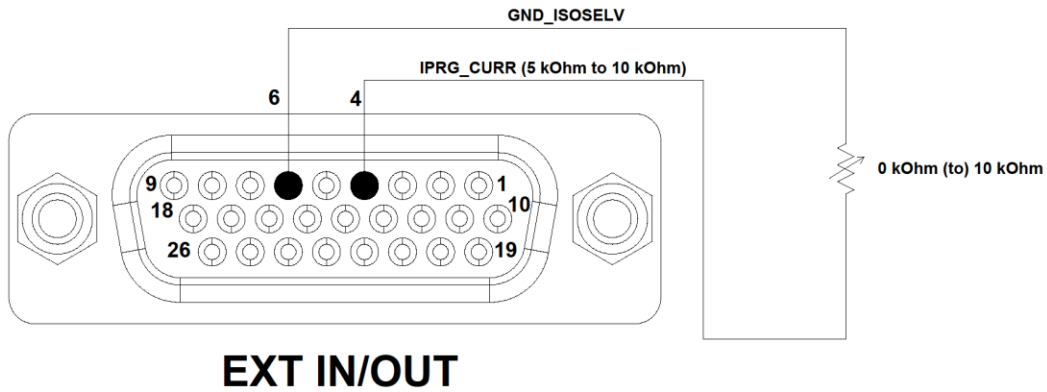

Figure 8-8. Remote Current Programming by Current Source

The programmable resistor is connected between Pin 4 (IPRG_CURR), ground Pin 6 (GND_ISOSELV) and the 'Analog Reference source' is selected as 'Current' from the front Panel. Refer to Figure 8-8.

The Full-Scale value for current programming can be modified to any value between 5 kΩ to 10 kΩ from the front panel screen or by using the digital interface SCPI Command. The default FSCR value is 10 kΩ, where 10 kΩ corresponds to 100% of the rated output current. The equation for current set from analog programming current source is as follows

$$I_{out} = R \times (100\% \text{ rated output current} / \text{FSC k}\Omega), \text{ with R in kilo ohms.}$$

NOTE: Remote current programming by current source is applicable only when operating source mode.

8.2.3.3 VOLTAGE MONITOR (VMON)

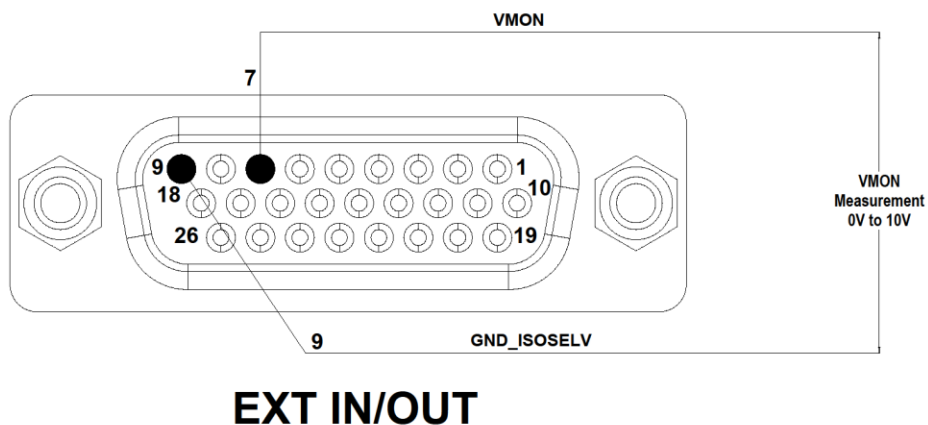

Figure 8-9. Voltage Monitor

Voltage Monitor provides functionality to monitor the scaled down output voltage of the power supply. Scaled down Output voltage could be monitored at VMON terminal of analog programming connector. Measurement of output voltage from 0 to 100% of full scale rated output corresponds to 0 to 10V.

8.2.3.4 CURRENT MONITOR (IMON)

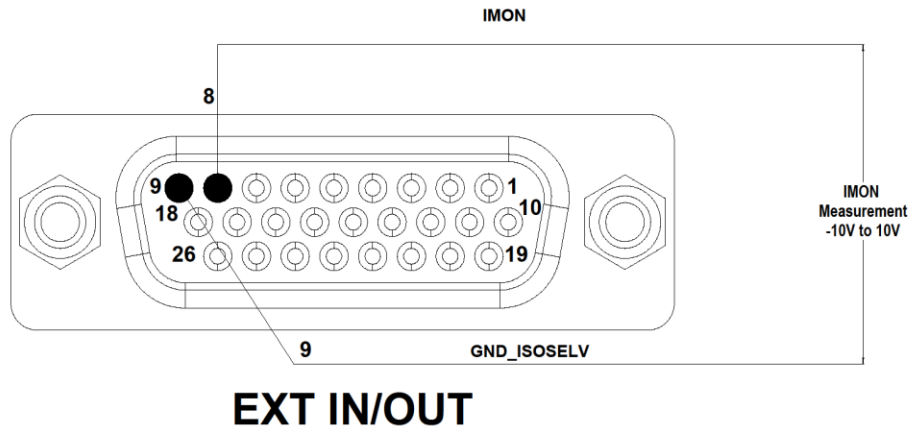

Figure 8-10. Current Monitor

Current Monitor provides functionality to monitor the scaled down output current of the power supply. Scaled down Output current could be monitored at IMON terminal of analog programming connector. Measurement of output current -100% to 100% of full-scale rated output corresponds to -10V to 10V.

8.2.3.5 DIO OUTPUT 1

Open collector transistor output for user programming.

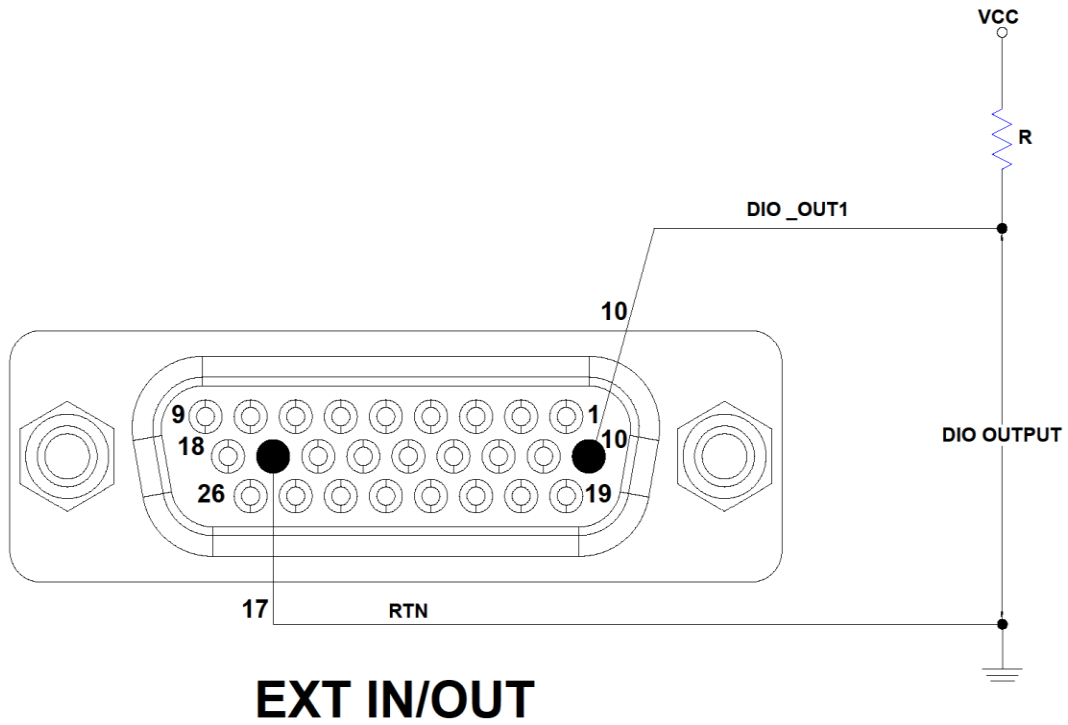

Figure 8-11. Dio Output 1

8.2.3.6 DIO OUTPUT 2

Open collector transistor output for user programming

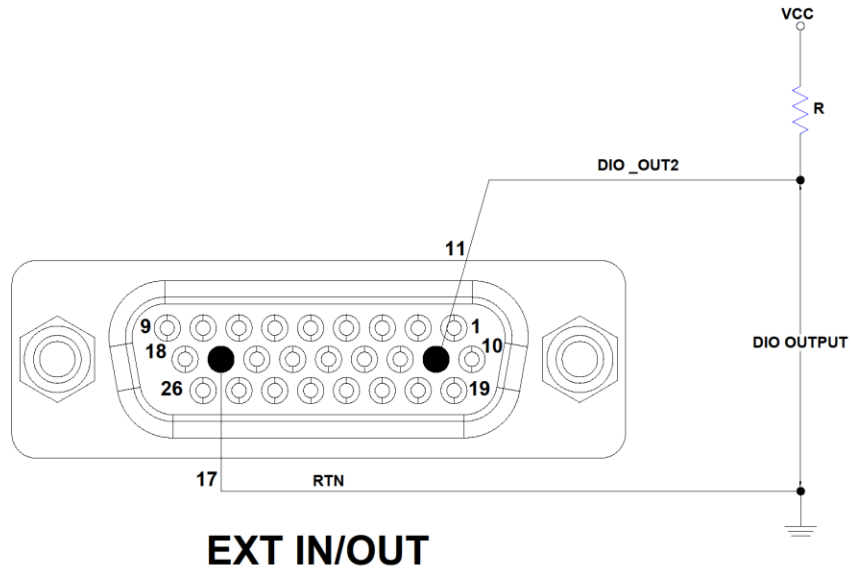

Figure 8-12. Dio Output 2

8.2.3.7 SOUR/SINK OUTPUT

The open collector transistor output has its collector connected to the 26-pin connector, while the pin-12 (SOUR/SINK_OUT) is connected to the common return pin-17 (RTN) of the interface connector. Status signal to communicate the direction of current flow.

- a) Low – indicates power transfer is from power supply to UUT.
- b) High – indicates power transfer is from UUT to Power supply.

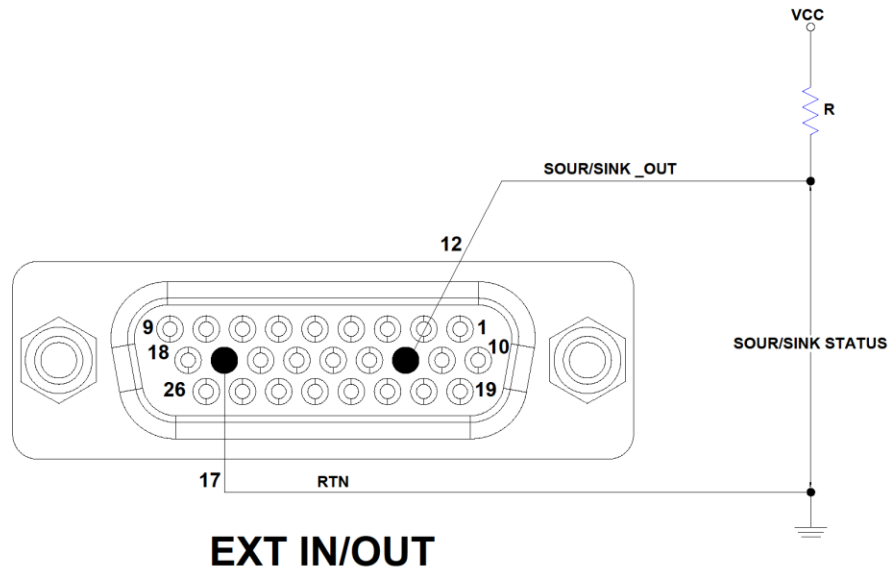
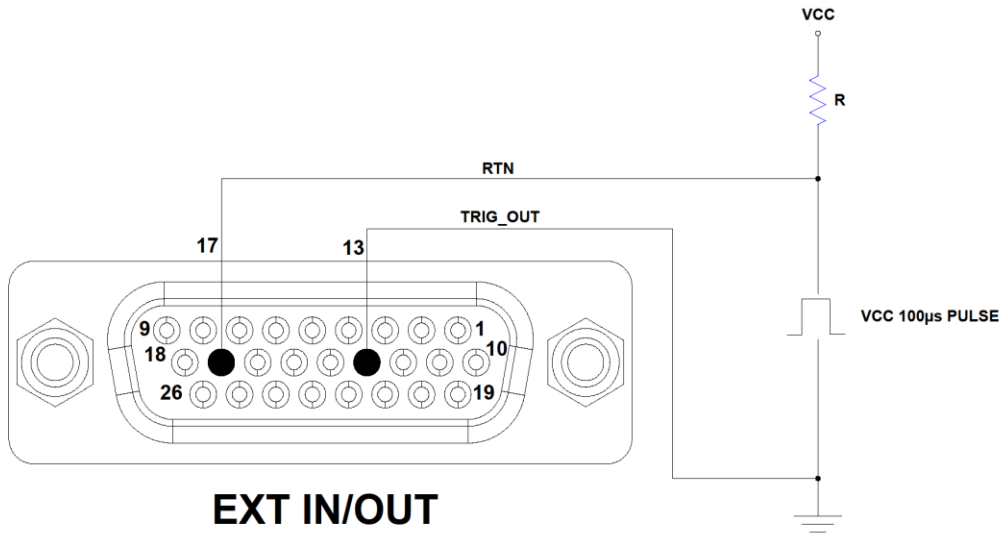

Figure 8-13. SOURCE/SINK Output**8.2.3.8 TRIGGER OUT FUNCTION (TRIG_OUT)**

The open collector transistor output has its collector connected to the 26-pin connector, while the emitter pin-13 (TRIG_OUT) and pin-17 (RTN) is common return of the interface connector. It provides an active-high synchronization pulse of 100 μ s.

**Figure 8-14. TRIG_OUT****8.2.3.9 DIO ON/OFF STATUS (DIO_ON/OFF_STAT)**

The open collector transistor output has its collector connected to the 26-pin connector, while the emitter Pin-14 (DIO_ON/OFF_STAT) and Pin-17 (RTN) is common return

of the interface connector. When the output is in a high state, it indicates that the output is ON, and when the output is in a low state, it indicates that the output is OFF.

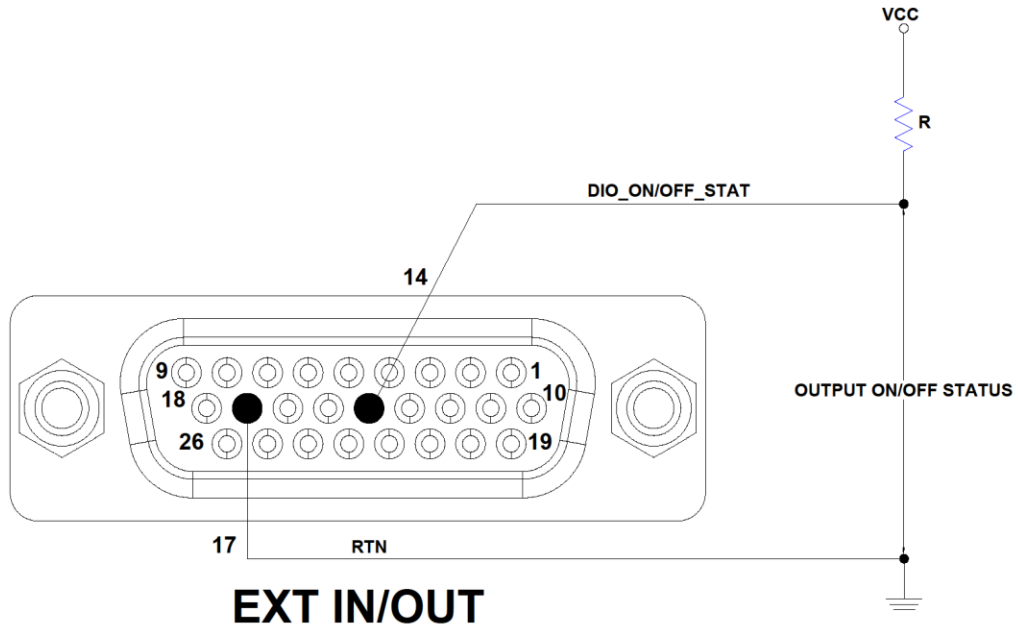

Figure 8-15. DIO_ON/OFF_STAT

8.2.3.10 DIO CC/CV OUTPUT (DIO_CC/CV_OUT)

The open collector configuration has its collector connected to the 26-pin connector, while the emitter Pin-15 (DIO_CC/CV_OUT) of the transistor is connected to the common return Pin-17 (RTN) of the interface connector. A high state indicates Constant Current mode operation, and a low state indicates Constant Voltage mode operation.

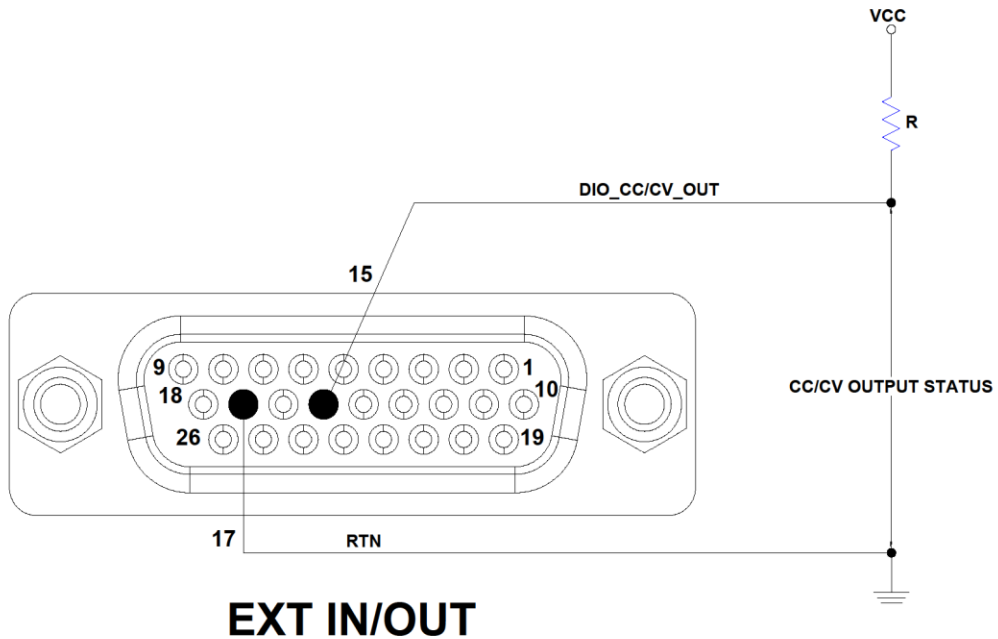

Figure 8-16. DIO_CC/CV_OUT

8.2.3.11 DIO FAULT OUTPUT (DIO_FAULT_OUT)

The open collector configuration has its collector connected to the 26-pin connector, while the emitter Pin-16 (DIO_FAULT_OUT) of the transistor is connected to the common return Pin-17 (RTN) of the interface connector. A high state indicates a fault state of the power supply.

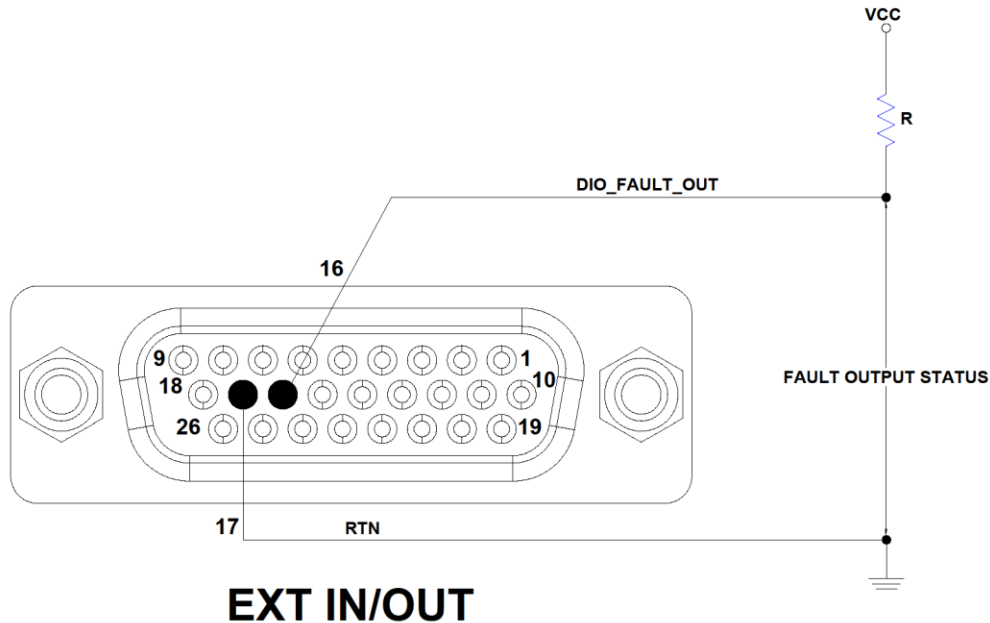

Figure 8-17. DIO_FAULT_OUT

8.2.3.12 TRIGGER IN FUNCTION (TRIG_IN)

The TTL-compatible input signal is an active-high pulse of 100 μs. This signal detects an external hardware trigger to Pin-19 (TRIG IN) and Pin-17 (RTN) at the falling edge of the active-high pulse for voltage, current ramp, and transient list functions. The signal connects to the open anode of the opto-isolator diode, which has an internal 1 kΩ series resistor within the power supply.

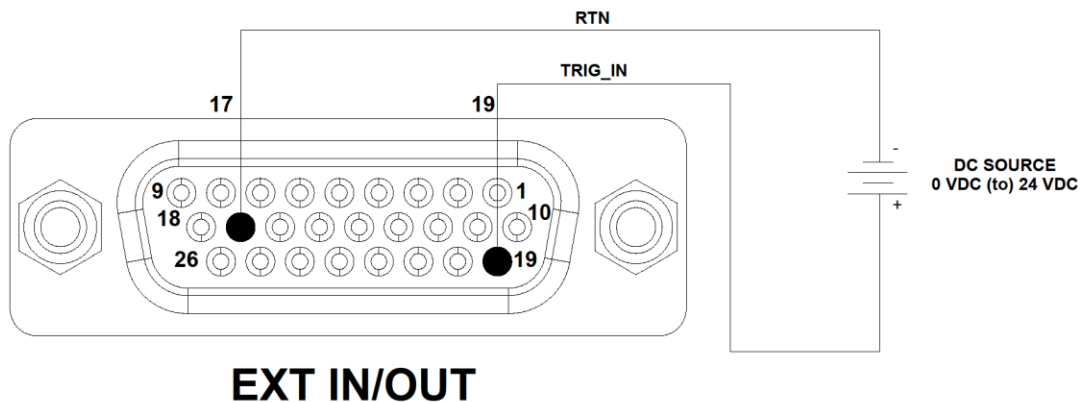
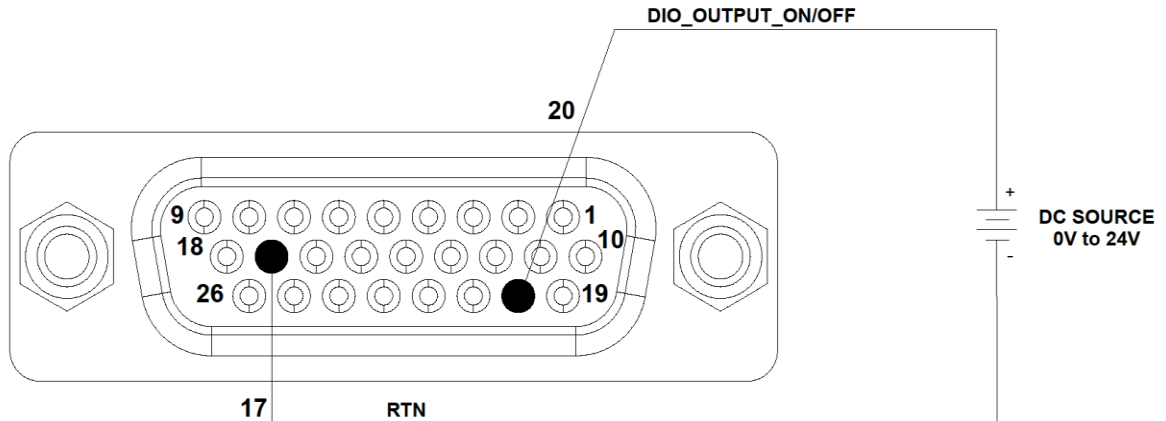

Figure 8-18. TRIG_IN**8.2.3.13 DIO OUTPUT ON/OFF (DIO_OUTPUT_ON/OFF)**

The remote-control input for output ON/OFF operates with a logic signal. A logic-high signal, 2.7-24 VDC TTL/CMOS, connected to Pin-20 (DIO_OUTPUT_ON/OFF) and Pin-17 (RTN), will enable the output of the supply, while a logic-low signal will disable the output.

**EXT IN/OUT****Figure 8-19. DIO_OUTPUT_ON/OFF****8.2.3.14 DIGITAL IN 1**

Remote-control input with a logic signal.

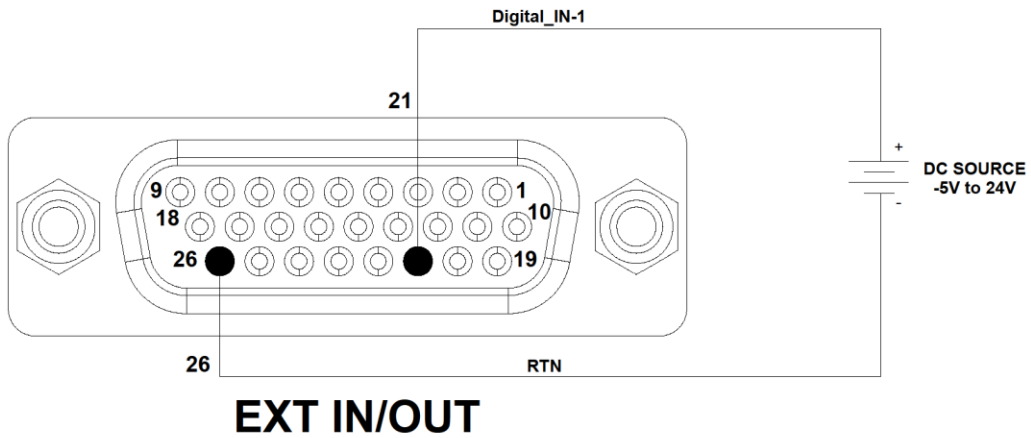

Figure 8-20. Digital IN 1

8.2.3.15 DIGITAL IN 2

Remote-control input with a logic signal.

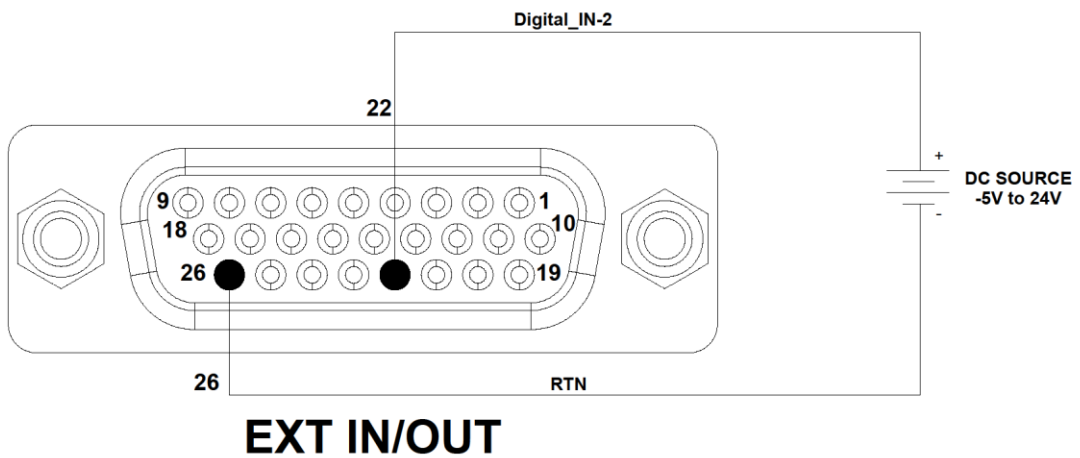

Figure 8-21. Digital IN 2

8.2.3.16 DIGITAL IN 3

Remote-control input with a logic signal.

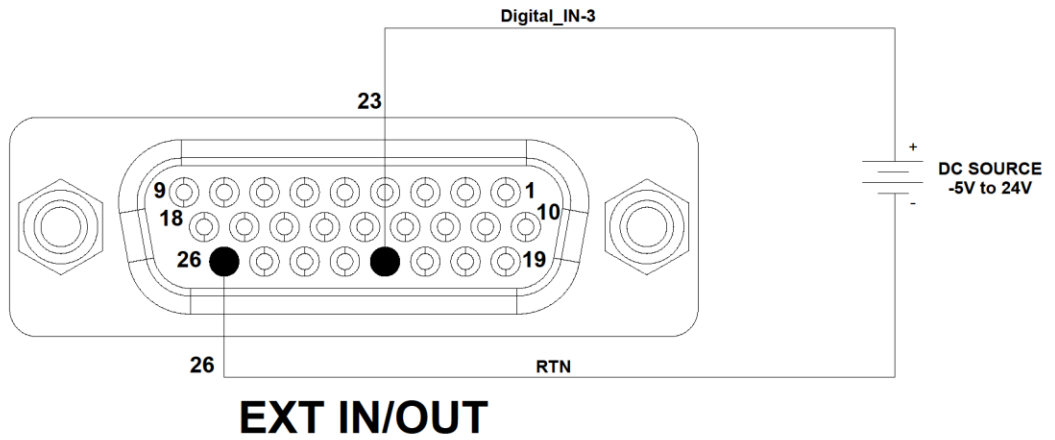

Figure 8-22. Digital IN 3

8.2.3.17 REMOTE INHIBIT ACTIVE VOLTAGE

For details related to the Remote Inhibit active voltage, refer to Section 8.2.2.

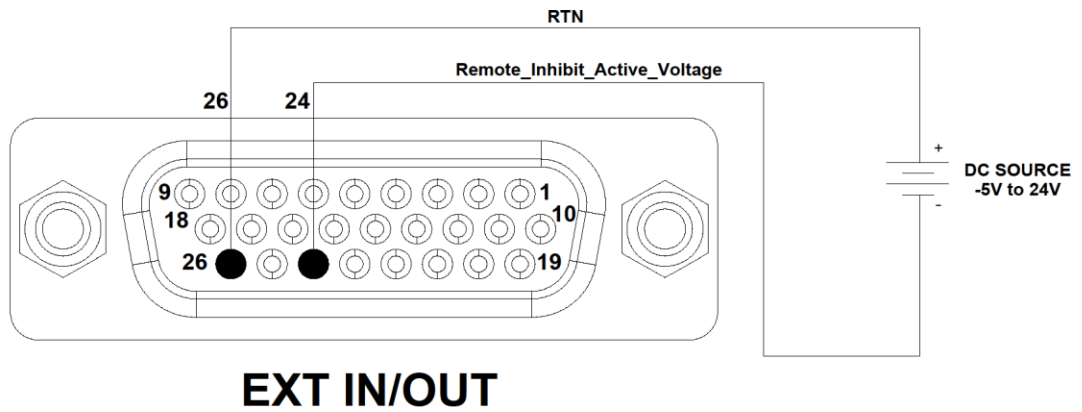

Figure 8-23. Remote Inhibit Active Voltage

8.2.3.18 REMOTE INHIBIT CONTACT CLOSURE

For details related to the Remote Inhibit contact closure, refer to Section 8.2.2.

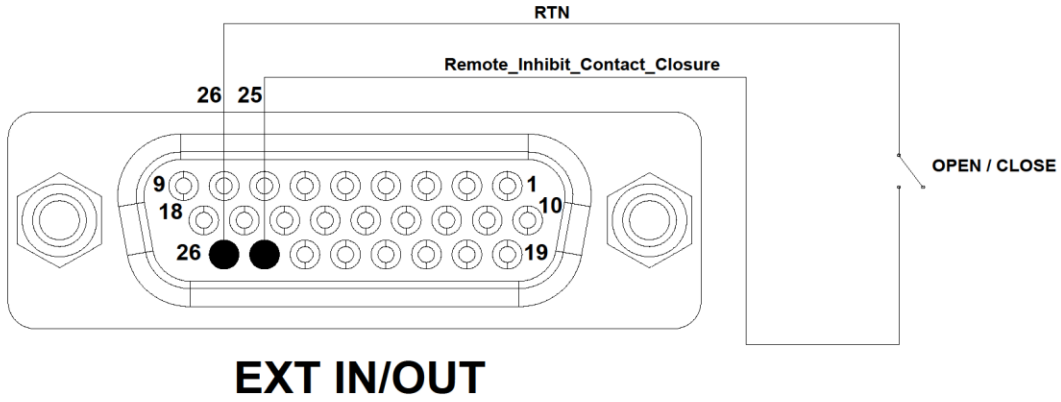

Figure 8-24. Remote Inhibit Contact Closure

9

RS232/ETHERNET/ IEEE 488.2 GPIB REGISTER COMMAND OPERATION

9.1 REGISTER DEFINITIONS

The Mi-BEAM Power Supply supports IEEE 488.2 GPIB, RS232, Ethernet, and SCPI status reporting data structures. These structures are comprised of status registers and status registers enable mask pairs. The following sections describe these pairs.

9.1.1 PROTECTION CONDITION AND PROTECTION EVENT STATUS REGISTER

These two registers have the same bit meanings, but they differ in function.

9.1.1.1 STATUS PROTECTION CONDITION REGISTER

Read the Protection Condition Register by issuing the following command.

```
STATus:PROTection:CONDtion?
```

The above command gives the present status condition of the power hardware, so the data is not latched. It is meant to be used as a polling register. The query value hexadecimal number of 32 bits. Bit value '1' indicates fault and '0' indicates normal condition.

For Example:

```
STAT:PROT:COND?
```

```
#H0000042 // Response for the above command
```

which means two bits are set: Constant voltage operation(0x02) and Fold back mode operation(0x40)

9.1.1.2 STATUS PROTECTION EVENT REGISTER OR FAULT REGISTER

Read the Protection Event Status Register by issuing the following command.

```
STATus:PROTection:EVENT?
```

Clear the Protection Event Status Register by issuing a '*CLS' command or a '*RST' command. Bits in the Protection Event Status Register will be set only when the corresponding bit in the

Protection Event Status Enable Register is set and the corresponding event occurs. The status is then latched and will remain in that state until it is read or cleared due to some command action.

9.1.1.3 STATUS PROTECTION ENABLE REGISTER OR FAULT REGISTER

Set the Status Protection Enable Register with the following command;

```
STATus:PROTection:ENABle <mask>
```

Read the Status Protection Enable Register with the following query command;

```
STATus:PROTection:ENABle?
```

Protection Enable Register used to select what fault events could set a bit in the Fault Register. Certain faults can occur even if they are not enabled in the Protection Enable Register. This is because the Protection Enable Register merely filters which events are allowed to affect the Fault Register, not whether those events can occur or not.

All the events in the protection condition register causes shutdown to the power supply, an exception to this rule involves the Constant Voltage Operation, Constant Current Operation, Constant Power Operation and Foldback Mode Operation bits. If these bits are not enabled in the protection enable register, then mode changes shall not cause a shutdown.

9.1.2 STANDARD EVENT STATUS REGISTER (ESR)

Read the Standard Event Status Register (ESR) by issuing the '*ESR?' command. Refer for the Standard Event Status Register bit details. Reading this register or issuing a '*CLS' command will clear the ESR. Use the '*ESE' to enable corresponding ESR bits to be summarized in the summary bit of the SCPI Status byte. To configure the Power Supply to generate service requests based on the ESR, both the Standard Event Status Enable Register, and the Service Request Enable Register must be programmed. Refer to Figure 9-1 SCPI Status Implementation and Table 9-1 for Standard Event Status Register.

BIT	HEX VALUE	DESCRIPTION
0	0x01	Operation Complete
1	0x02	Request Control - not used
2	0x04	Query Error
3	0x08	Device Dependent Error
4	0x10	Execution Error (e.g., range error)
5	0x20	Command Error (e.g., syntax error)
6	0x40	User Request - not used
7	0x80	Power On

Table 9-1. Standard Event Status Register

The SESER (Standard Event Status Enable Register). This register is read using the *ESE? SCPI query command. This register is written to using the *ESE <value> command. A "1" in the appropriate bit location enables that corresponding bit from the SESR to pass through to the input of the OR gate to be included in the SESR summary bit (bit 5) in the SCPI Status Byte.

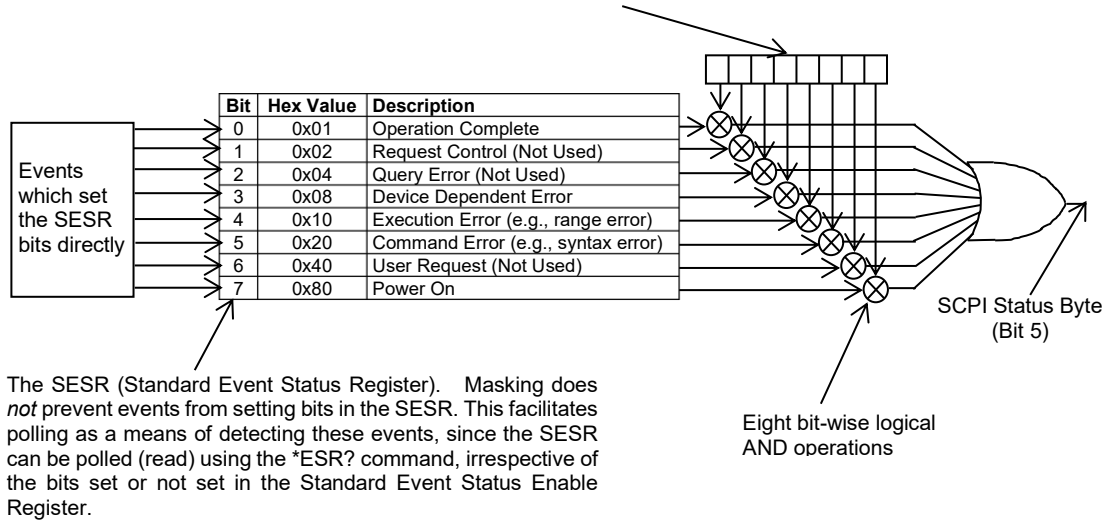

Figure 9-1. Standard Event Status and Standard Event Status Enable Register

9.1.3 SCPI STATUS BYTE

The SCPI Status Byte registers the status of the instrument, in one of seven bits described in Table 9-2. Read the SCPI Status Byte status register by issuing either the '*STB?' command or a serial poll. Clear the Status Byte status register by issuing the '*CLS' command.

NOTE: Serial poll is applicable only to GPIB interface.

The Power Supply can be configured to request service from any of the communication interfaces, by setting the appropriate bits in the Service Request Enable Register (SRE), which has the same bit pattern as the status byte. Service Request Enable Register (SRE) can be modified by issuing the '*SRE <mask>' command. Service Request Enable Register (SRE) can be read by issuing '*SRE?' query command, Refer to Figure 9-2.

For Example:

If the SRE register is set to 0x02 (Protection Event Flag), when the Power Supply has a fault event, Status Byte register will contain 0x42 (RQS and Protection Event Flag) and the SRQ (SRQ is supported only on GPIB) line will be asserted to indicate a request for service. Refer to Figure 9-2.

Bit	Hex Value	Description
0	0x01	Not used.
1	0x02	Protection Event Status flag. Indicates the selected protection event occurred.
2	0x04	Error/event queue message available. Set when any error/event is entered in the System Error Queue. It is read using the 'SYSTEM:ERROR?' query.
3	0x08	Questionable Status flag. Indicates the quality of the current data being acquired. This bit is not used.
4	0x10	Message available (MAV). Indicates a message is available to read (Only applicable to GPIB Interface).
5	0x20	Standard Event Status Register (ESR). Summary bit for the ESR. Set when any of the ESR bits are set and cleared when the ESR is read.
6	0x40	Request Service flag (RQS) for serial polling or Summary Status (SS) in response to '*STB?' If service requests are enabled (with the '*SRE' command), this bit represents the RQS and will be sent in response to a serial poll, then cleared. The SS bit indicates that the device has at least one reason to request service. Even though the device sends the SS bit in response to a status query (*STB?), it is not sent in response to a serial poll. It is not considered part of the IEEE-488.1 Status Byte.
7	0x80	Operation Status flag. Indicates the current operational state of the unit. This bit is not used.

Table 9-2: SCPI Status Byte

The Service Request Enable Register (SRE). Used to enable which Status Byte bits can affect the service request bit. *SRE? reads. *SRE <value> writes.

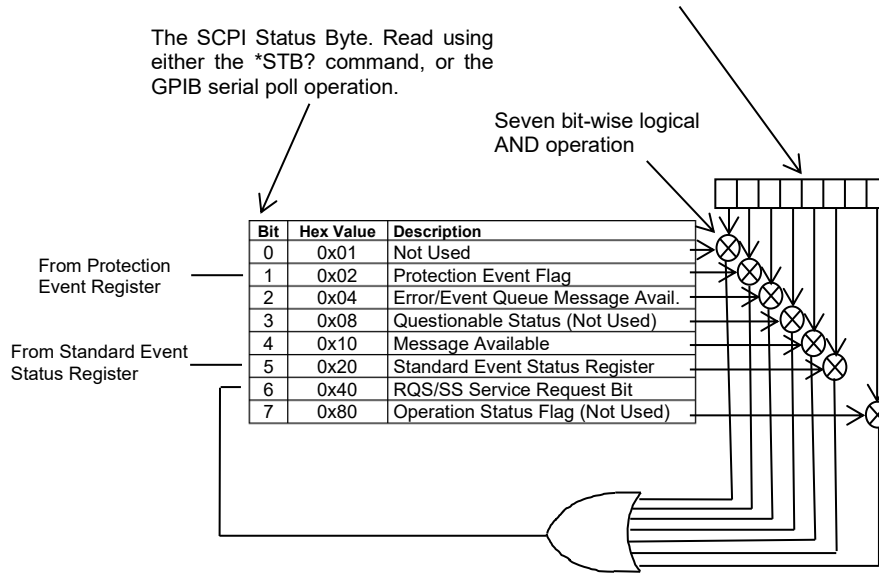

Figure 9-2. SCPI Status Byte and Service Request Enable Register

9.1.4 ERROR OR EVENT QUEUE

Errors that occur during operation from either the front panel or the remote digital interface will result in error messages. Error messages are stored in memory allocated to the error message queue. The error messages in the queue can be read using the SCPI query command, `SYST:ERR?`. The error queue has a finite depth; if more error messages are generated than can be held in the queue, a queue overflow message will be put in the last queue location. To empty the queue, read out the error queue until the message “No Error” is received.

NUMBER	MESSAGE STRING	CAUSE	REMEDY
000	No error	No errors in the queue	Normal operation
001	Self-test pending	Self-test in progress	Wait for the self-test to complete
008	Feature Not Supported	The command might be inconsistent with the current device settings.	Check the Programming Manual to ensure if the command is supported in current device setting.
-101	System too Busy	System is busy performing previously requested operation.	Wait for the operation to complete.
-102	Syntax error	SCPI command syntax incorrect, unrecognized command or data type	Correct command syntax, e.g. misspelled or unsupported commands.
-200	Execution error	The command could not be executed	Error occurred executing the command.
-203	Command protected	The command is locked out	Some commands are supported by the unit but are locked out for the protection of settings and are not user accessible until it is unlocked.
-221	Settings conflict	Requested setting conflicts with other settings in effect	Check settings: e.g., changing regulation setting, CC/CV is not allowed if the programming type is voltage.
-222	Parameter out of range	Parameter data outside of the allowable range	Check the Programming Manual for allowable parameter values.
-250	Directory full	No sufficient space to save new files.	Delete one or more files from the unit to make room.
-251	Directory not found	Unable to find the directory where the files are stored	Reboot the unit, contact factory if the issue persists.
-252	File name error	Incorrect filename	Check file (profile/list) name definition exceeds 29 characters.
-253	File not found	Unable to find the selected file name.	Ensure that the file is available in unit before selection.
-254	File read error	Error while reading the file (profile/list) data from the unit.	Retry, if the issue persists, delete and create a new file.
-255	Parameters count not matching as per configured size	Size declared and number of entered parameters are not matching.	Ensure that the declared size and parameter count matches.
-257	CRC value for file contents changed	Saved file (profile/list) data is corrupted.	Retry, if the issue persists, delete and create a new file.

NUMBER	MESSAGE STRING	CAUSE	REMEDY
-258	Battery configuration not loaded	Battery configuration file (profile/list) is not loaded.	Ensure that the battery configuration is loaded before turning ON the output.
-260	Name already exist	Creating the file (profile/list) with a name that already exists.	Ensure that the file (profile/list) name is not same as the previously saved file (profile/list).
-331	System error	Error occurred during performing the requested operation.	Ensure that the operation requested does not conflict the state system is in.
-350	Queue overflow	Message queue full	Read status using 'SYST:ERR' query until 0; 'No Error' is received indicating queue empty.
-351	Data not saved	Trying to load a file (profile/list) which is not saved.	Ensure that the data is saved
-352	Model identification in progress, please retry again	Cannot execute command, module identification in progress.	Wait for the module identification to complete.
-353	File not selected	Cannot execute file (profile/list) operation command.	Ensure that the file (profile/list) is selected before sending any file (profile/list) related commands such as load or delete.
-354	Data not initialized or loaded	Selected file (profile/list) is not loaded before output ON.	After selecting the file ensure it is loaded before turning ON the output.
-357	Command not supported in selected operating mode	Command not supported in selected operating mode.	Ensure that the command sent is related to the selected operating mode.

Table 9-3: SCPI Error Codes

9.1.5 SERIAL POLL OPERATION

Performing a serial poll will not modify the SCPI Status Byte other than to clear the RQS (bit 6) for a Mi-BEAM Power Supply requesting service. Queries affecting the Status Registers and subsequent serial poll are described below.

'*ESR?' clears the ESR and bit 5 of the SCPI Status Register

'SYSTEM:ERROR?' clears bit 2 of the SCPI Status Register if the queue is empty.

9.1.6 FAULT STATUS

Power Supply faults status can be identified by sending the following command.

STAT:MOD:COMPL:STATUS?

This would return Hex value of the fault state value. The following fault states are supported by the Mi-BEAM series power supply, refer Table 9-4.

NUMBER	DESCRIPTION	EXPLANATION	ACTION TO BE TAKEN
0x0000000 1	Overvoltage Protection Fault	Output voltage of Mi- BEAM has exceeded the programmed Over Voltage protection (OVP) limit. OVP is an instantaneous trip. Hence, applying (or generating) an output voltage close to OVP limit may trigger this fault. Hence, always program the OVP trip limit well above the set voltage and applied output voltage. The OVP trip limit ensures that unit voltage will never exceed the programmed OVP limit, thus protecting the connected UUT from overvoltage failure.	<p>a) Check if sufficient margin is available between voltage applied (or generated) at the output and OVP limit. If possible, increase the set value of OVP to resolve the trip. Else, restrict the applied (or generated) voltage at the output terminal well within the OVP limit.</p> <p>b) If OVP limit is set from external Analog source, ensure that sufficient margin is provided between the set voltage (corresponding to the applied analog voltage) and the OVP limit.</p>
0x0000000 2	Overcurrent Protection Fault	Output Current exceeded Over Current trip limit. OCP is an instantaneous trip. Hence, supplying (or drawing) an output current close to OCP limit may trigger this fault. Hence, always program the OCP trip limit well above the set current and load current. The OCP trip limit ensures that unit current will never exceed the programmed OCP limit, thus protecting the connected UUT from overcurrent failure.	Check if sufficient margin is available between current supplied or drawn from the output and OCP limit. If possible, increase the set value of OCP to resolve the trip. OCP can be accessed as follows from front panel (Dashboard Home button -> Configuration -> Protection -> Pos. OCP/Neg. OCP.) Else, restrict the current supplied or drawn from the output terminal well within the OCP limit.
0x0000000 4	Foldback Fault	Output trip is activated due to foldback operation setting. Foldback operation corresponds to the regulation operation other than the main regulation operation. E.g.: Assume that user has selected CC mode as the regulation setting. Then, both CV and CP modes are foldback regulation operation. If the protection limit corresponding to Volt high or Volt low or Power high or	Check the foldback operation setting from 'OUTP:PROT:FOLD?' Query and modify as required

NUMBER	DESCRIPTION	EXPLANATION	ACTION TO BE TAKEN
		Power low is hit during a Current control (CC) operation occurs, then a foldback fault is displayed. Similarly in CC/CV mode of operation, Power high or Power low is hit, then also a foldback fault is triggered. It is to be noted that in CC/CV mode if voltage high limit is hit, then present regulation operation is changed from current control to voltage control.	
0x00000008	External Shutdown	External Shutdown activated from External Analog Programming Connector (contact closure or Vsource)	Check the external shutdown configuration and the signals are connected as per the configuration
0x00000010	Module 1 Fault	Internal Module-1 Fault. It can happen when module power stage parameter (like voltage current, power or temperature) exceeds the limit.	<p>a) Try restarting the power supply and it may go away if it was caused due to a sudden supply input or an output load transient.</p> <p>b) To understand what fault occurred, query 'SYSTEM<CHASSNO> : MODULE1 : FAULT : STATUS?'</p>
0x00000020	Module 2 Fault	Internal Module-2 Fault. It can happen when module power stage parameter (like voltage current, power or temperature) exceeds the limit.	<p>a) Try restarting the power supply and it may go away if it was caused due to a sudden supply input or an output load transient.</p> <p>b) To understand what fault occurred, query 'SYSTEM<CHASSNO> : MODULE2 : FAULT : STATUS ?'</p>
0x00000040	Module 3 Fault	Internal Module-3 Fault. It can happen when module power stage parameter (like voltage current, power or temperature) exceeds the limit.	<p>a) Try restarting the power supply and it may go away if it was caused due to a sudden supply input or an output load transient.</p> <p>b) To understand what fault occurred, query 'SYSTEM<CHASSNO> : MODULE3 : FAULT : STATUS?'</p>

NUMBER	DESCRIPTION	EXPLANATION	ACTION TO BE TAKEN
0x0000008 0	Module 1 Over temperature fault	<p>Internal Module 1 Over temperature fault. This refers to an increased temperature more than the specified limit in one of the power stages of module-1. The over-temperature fault would occur due to following reasons;</p> <p>a) Blockage of airflow in chassis air vents.</p> <p>b) Fan not running at sufficient speed.</p> <p>c) The chassis is operated at an elevated room temperature more than that specified level</p> <p>d) Due to hardware issue.</p>	<p>a) Try restarting the power supply.</p> <p>b) To understand what fault occurred, query 'SYSTEM<n>:MODULE1:TEMPERATURE:FAULT:STATUS?' command to know detailed temperature fault status</p>
0x0000010 0	Module 2 Over temperature fault	<p>Internal Module 2 Over temperature fault. This refers to an increased temperature more than the specified limit in one of the power stages of module-2. The over-temperature fault would occur due to following reasons;</p> <p>a) Blockage of airflow in chassis air vents.</p> <p>b) Fan not running at sufficient speed.</p> <p>c) The chassis is operated at an elevated room temperature more than that specified level</p> <p>d) Due to hardware issue.</p>	<p>a) Try restarting the power supply</p> <p>b) To understand what fault occurred, query 'SYSTEM<n>:MODULE2:TEMPERATURE:FAULT:STATUS?' command to know detailed temperature fault status</p>
0x0000020 0	Module 3 Over temperature fault	<p>Internal Module 3 Over temperature fault. This refers to an increased temperature more than the specified limit in one of the power stages of module-3. The over-temperature fault would occur due to following reasons;</p>	<p>a) Try restarting the power supply</p> <p>b) To understand what fault occurred, query 'SYSTEM<n>:MODULE3:TEMPERATURE:FAULT:STATUS?' command to know detailed temperature fault</p>

NUMBER	DESCRIPTION	EXPLANATION	ACTION TO BE TAKEN
		<p>a) Blockage of airflow in chassis air vents.</p> <p>b) Fan not running at sufficient speed.</p> <p>c) The chassis is operated at an elevated room temperature more than that specified level.</p> <p>d) Due to hardware issue.</p>	status.
0x0000040 0	Remote Analog Programming Error	Remote programming Analog signal level is out of the specified range. Remote Analog Programming error can occur when the applied voltage/connected resistance in any of the analog programming pins of 26-Pin Digital I/O interface (e.g.: VPRG_VOLT, VPRG_CURR, IPRG_VOLT, IPRG_CURR, or OVPRG_VOLT) has exceeded the full scale rated output voltage or is lower than minimum limit specified.	Ensure that the analog reference value given is within the Full-scale value configured in the analog programming.
0x0000080 0	AC input Line Fault	AC input voltage to the power supply is not in specified operating range. This fault will be triggered if a unit configured as Low line and is supplied with input voltage corresponding to High line. The fault will also be triggered if the input supply voltage goes out of limit due to a voltage swell or sag during operation.	<p>a) Check if input voltage to the supply is within specified range (allowed input voltage ranges are, Low line: 180-264V, High line: 342-528V).</p> <p>b) Try restarting the power supply.</p>
0x0000100 0	NEG_POLARITY_FAULT	Negative voltage polarity is applied at the output of isolation relay. Since the unit can have only positive voltage applied at the output, the isolation relay will be operated only when there is positive voltage at its terminal. Applying a negative voltage at the load side of isolation relay	Check if voltage at the load side of isolation relay terminal is not negative and is within the range specified in datasheet.

NUMBER	DESCRIPTION	EXPLANATION	ACTION TO BE TAKEN
		terminal will trigger this fault.	
0x0000200 0	Fan1 Fault	Fault from cooling Fan-1. This condition is caused when Fan is not running at the required speed for cooling the unit.	<p>a) Check if the fan is running.</p> <p>b) Clear the fault or try restarting the power supply.</p>
0x0000400 0	Fan2 Fault	Fault from cooling Fan-2. This condition is caused when Fan is not running at the required speed for cooling the unit.	<p>a) Check if the fan is running.</p> <p>b) Clear the fault or try restarting the power supply.</p>
0x0000800 0	Fan3 Fault	Fault from cooling Fan-3. This condition is caused when Fan is not running at the required speed for cooling the unit.	<p>a) Check if the fan is running.</p> <p>b) Clear the fault or try restarting the power supply.</p>
0x0001000 0	Calibration Fault	<p>Calibration data is not within the required range.</p> <p>Reasons: Calibration data is corrupted or EEPROM is not working, or calibration data is invalid.</p>	Restart the unit and do the calibration.
0x0002000 0	Remote Sense Fault	<p>Remote voltage sense fault occurs if;</p> <p>a) The remote sense voltage is out of range from power supply voltage specification.</p> <p>b) There is a difference between the sensed voltage at the output terminal and the sensed voltage of the remote sense terminal.</p>	<p>a) Check if the cable connected to remote voltage sense connector at rear side of the power supply is intact and polarity is correct.</p> <p>b) Check the output cable line voltage drop and make sure line voltage drop across cable is not exceeding limit specified in datasheet.</p>
0x0004000 0	Module Output Mismatch Fault	Module output currents or voltages are not equal. This fault is triggered when there is a mismatch in the current sharing between the modules in 600 V chassis or a mismatch in module voltages in 1500/2000 V chassis. The modules are expected to share the output current/voltage equally. However, during large output transients or during a hardware fault, the current/voltage sharing may	Try restarting the power supply.

NUMBER	DESCRIPTION	EXPLANATION	ACTION TO BE TAKEN
		not be equal resulting in module output mismatch fault. This fault protects the individual module from current/voltage overload.	
0x0008000 0	OPP_FAULT	Output power of the unit has exceeded the Overpower protection (OPP) limit. OPP is an instantaneous trip and is not a programmable feature. The OPP trip limit is kept higher than the model power limit. The OPP trip limit ensures that unit power will never exceed the unit's power rating, even during output transient conditions, thus protecting the unit and the connected UUT from overpower failure.	Ensure that the unit is operated within the model power limit.
0x0010000 0	VSNS_OUTP_SYN C_FAULT	Not able to synchronize Mi-BEAM output voltage with isolation relay output voltage. This fault is checked only when Isolation relay feature of the unit is enabled. The fault occurs when the unit is not able to produce an output voltage equal to the load side voltage of isolation relay when the unit output is turned ON. This would happen if the load side voltage is either negative or is set more than the model voltage limit.	<p>a) Check if voltage applied at the load side of isolation relay is negative or more than the model voltage limit.</p> <p>b) Clear the fault or try restarting the power supply.</p>
0x0020000 0	Module Firmware Mismatch Fault	Firmware versions of the Module Controllers are not matching	<p>a) Check if all the primary module controller firmware versions are the same.</p> <p>b) Check if all the Secondary module controller firmware versions are same.</p> <p>c) Try restarting the power supply if fault persists Contact factory.</p>
0x0040000 0	CHASSIS_MOD_E NUMERATION_FA ULT	Module present signal not matching with Number of modules	Try restarting the power supply if fault persists Contact factory.

NUMBER	DESCRIPTION	EXPLANATION	ACTION TO BE TAKEN
0x0080000 0	CHASSIS STARTUP SEQ FAULT	Startup sequence of power modules is not completed within stipulated time. This would happen under the following conditions: a) If the AC input line voltage is not sufficient for charging the DC bus b) There is a hardware fault	a) Check if input voltage to the supply is within specified range in datasheet; Allowed input voltage range: Low line: 180-264 V, High line: 342-528 V b) Try restarting the power supply if fault persists Contact factory
0x0100000 0	Parallel Cable Fault	This fault occurs if: a) Chassis Parallel cables PARALLEL IN/ PARALLEL OUT cables are disconnected. b) Enumeration does not complete within the specified time during bootup.	a) Reset the PARALLEL IN/ PARALLEL OUT cables as required and power cycle the units of parallel chassis configuration. b) Check if there is any damage in the parallel cable
0x0200000 0	Paralleled System Incompatible	Voltage and Power Model limits are different in paralleled units. Parallel operation is allowed only for units with the same voltage rating, power rating and firmware versions only.	Check the Unit model details of all the paralleled system and make sure all units are of same Voltage model, Power model and all units are in same AC input line setting (Low/High).
0x0400000 0	Parallel System Fault	Fault occurred in any one of the parallel systems including leader	a) Get the chassis address of the parallel units having fault using SCPI command. c) Query command 'SYSTEM<LEADER CHASSIS ADDRESS>: FAULT: CHASSIS?' will give you which Parallel chassis has detected fault. b) Query 'SYSTEM<Chassis Address>: FAULT: STATUS ?' for individual unit faults c) Power cycle all the units of Parallel chassis configuration
0x0800000 0	Parallel chassis current sharing fault	Any of the unit's current is out of 10% margin from the current reference value given by the LEADER unit.	a) Power cycle all the units of Parallel chassis configuration.

NUMBER	DESCRIPTION	EXPLANATION	ACTION TO BE TAKEN
			b) Check if there is damage in the parallel cable. c) Recalibrate the units (measurement calibration)
0x1000000 0	RESERVED	RESERVED	RESERVED
0x2000000 0	RESERVED	RESERVED	RESERVED
0x4000000 0	RESERVED	RESERVED	RESERVED
0x8000000 0	RESERVED	RESERVED	RESERVED

Table 9-4: Fault Status

9.2 SCPI CONFORMANCE INFORMATION

The syntax of all SCPI commands implemented by the Mi-BEAM power supplies and documented in this manual, are either SCPI confirmed, or they are customized commands not part of the SCPI definition. None of the commands implemented by the Mi-BEAM power supplies are classified as SCPI approved commands (approved by the SCPI Consortium but not contained in the SCPI version to which the MI-BEAM power supplies conform).

To document whether the syntax of each command is SCPI compliant or not, this manual provides a column, labelled “SCPI”, in each command reference table. A “C” in the “SCPI” column means that the command syntax is SCPI compliant; an “N” in the “SCPI” column means that the command syntax is not part of the SCPI definition.

9.2.1 PARAMETER DEFINITIONS

The following table describes the format of the command arguments, when applicable.

PARAMETER DEFINITIONS	
TYPE	VALID ARGUMENTS
<boolean>	“ON” or 1. “OFF” or 0.
<NR1>	The data format <NR1> is defined in IEEE 488.2 for integers. Zero, positive and negative integer numeric values are valid data.
<NRf>	The data format <NRf> is defined in IEEE 488.2 for flexible Numeric Representation. Zero, positive and negative floating point numeric values are some examples of valid data.

PARAMETER DEFINITIONS	
TYPE	VALID ARGUMENTS
<string>	Characters enclosed by single or double quotes.

Table 9-5. Parameter Definitions

9.2.2 CONVENTIONS

SCPI uses the conventions where optional commands and parameters are enclosed by “[]”. Additionally, the shorthand version of a command is indicated by capital letters.

For Example:

```
SOURce:VOLTage[:LEVel][:IMMediate][:AMPLitude] 120.0
```

can be written as

```
SOURce:VOLTage 120.0
```

OR

```
SOUR:VOLT 120.0
```

9.2.3 QUERIES

The query syntax is identical to the command syntax with a “?” appended.

For Example:

To query the programmed voltage, send the string: `SOURce:VOLTage?`. A subsequent device read will return a value such as “33.000”. All queries are terminated with a carriage return and line feed (0x0D 0x0A). When the power supply has nothing to report, its output buffer will contain two ASCII characters: a carriage return and linefeed (in decimal the values are: <13><10>).

9.3 IEEE 488.2 COMMON COMMAND SUBSYSTEM

The following commands are common to all SCPI instruments and declared mandatory by IEEE 488.2. In the following table, the power supply is defined as the “device” on the GPIB bus.

COMMAND	DESCRIPTION
*CLS	Clears all status reporting data structures including the Status Byte, Standard Event Status Register, and Error Queue. The STAT<n>:PROT:ENAB (protection event enable register) is cleared by this command; other enable registers are not cleared by this command.
*ESE <0+NR1>	Sets the value of the Standard Event Status Enable Register that determines which bits can be set in the Standard Event Status Register. Refer Section 9.1.2 for valid values.
*ESE?	Returns the integer value of the Standard Event Status Enable Register Refer Section 9.1.2 for valid values. Response: <0+NR1>
*ESR?	Returns the integer value of the Standard Event Status Register. The ESR and the Status Byte ESR bit are cleared. Refer Section 9.1.2 for valid values. Response: <0+NR1>
*IDN?	Returns the device identification as an ASCII string. Response: <Manufacturer>, <UUT model Configuration>, <serial number>,<SC firmware version>, AIB firmware version>,<FPC firmware version> SC-System Controller AIB- Analog Interface Board FPC- Front Panel Controller
*IDN<n>?	Returns the Channel identification as an ASCII string. Response: <Manufacturer>, <UUT Channel Configuration>, <serial number>,<SC firmware version>, AIB firmware version>,<FPC firmware version> SC-System Controller AIB- Analog Interface Board FPC- Front Panel Controller
*OPC	Enables the Operation Complete bit of the Standard Event Status Register to be set when all pending operations are complete. Refer Section 9.1.2
*RST	Resets the supply to its Power ON (PON) state. Clears all status reporting data structures including the Status Byte, Standard Event Status Register, and Error Queue. The STAT<n>:PROT:ENAB (protection event enable register) is cleared by this command; other enable registers are not cleared by this command.
*RST<n>	Resets the respected channel to its Power ON (PON) state. Clears all status reporting data structures including the Status Byte, Standard Event Status Register, and Error Queue. The STAT<n>:PROT:ENAB (protection event enable register) is cleared by this command; other enable registers are not cleared by this command.
*SRE <0+NR1>	Sets the value of the Service Request Enable Register, which determines which bits in the Status Byte will cause a service request from the device. See section on Status Byte for valid values.
*SRE?	Returns the integer value of the Service Request Enable Register. See section on Status Byte for valid values. Values range from 0-63 or 128-191. Response: <0+NR1>

COMMAND	DESCRIPTION
*STB?	Returns the integer value of the Status Byte with bit 6 representing the Summary Status (SS) instead of RQS. The SS bit acts as a summary bit for the Status Byte and indicates whether the device has at least one reason to request service based on the MAV and the ESR bits. See section on Status Byte for valid values. Values range from 0-255. Response: <0+NR1>
*TST	Performs the self-test for the power supply and reserves the self-test status with device.
*TST?	Returns the integer value of self-test status (*TST). Value ranges from 0-63. Response: <0+NR1>
*TST<n>	Performs the self-test for the power supply and reserves the self-test status with device.
*TST<n>?	Returns the integer value of self-test status (*TST<n>). Value ranges from 0-63. Response: <0+NR1>

Table 9-6. Common Command Subsystem

9.4 SOURCE SCPI COMMAND SYSTEM

This section first presents a tree summary of the Source commands and then provides a tabular description

9.4.1 SOURCE SCPI COMMAND SUMMARY

```

SOURCE
  :ANALOG
    :REMOte
      :OUTPut <NRf>
      :OUTPut?
  :CURRent <fval>
  :CURRent
    :MAXimum?
    :MINimum?
    :MONitor
      :FSC <NRf>
      :FSC?
    :NEGative
      :LIMit
      :LIMit?
      :LIMit
        :MAXimum?
        :MINimum?

```

```

SOURce
:CURRent
  :POSitive
    :LIMit
    :LIMit?
    :LIMit
      :MAXimum?
      :MINimum?
  :PROGram
    :FSC <fval>
    :FSC?
    :FSCR <NRF>
    :FSCR?
  :PROTection
    :NEGative
    :NEGative?
    :NEGative
      :MAXimum?
      :MINimum?
    :POSitive
    :POSitive?
    :POSitive
      :MAXimum?
      :MINimum?
  :RAMP <startvolt,endvolt,ramptime,HW/SWTrigger>
  :RAMP
    :ABORT
    :SLEW
    :SLEW?
    :STATUs?
  :RAMP?
  :SLEW
    :MAXimum?
    :MINimum?
  :SLEW?
  :SOFT
    :LIMit
      :HIGH
      :HIGH?
      :LOW
      :LOW?
:CURRent
  :PROGram <val>
  :PROGram
    :SOURce
    :SOURce?
  :PROGram?
:CURRent?

```

```
SOURCE
  :DIO
    :OUT1
    :OUT1?
    :OUT2
    :OUT2?
  :EXternal
    :CONTROL
      :REL1
      :REL1?
      :REL2
      :REL2?
  :POWER <fval>
  :POWER
    :MAXimum?
    :MINimum?
    :NEGative
      :LIMit <fval>
      :LIMit?
      :LIMit
        :MAXimum?
        :MINimum
    :POSitive
      :LIMit <fval>
      :LIMit?
      :LIMit
        :MAXimum?
        :MINimum?
    :SOFT
      :LIMit
        :HIGH
        :HIGH?
        :LOW
        :LOW?
  :POWER?
  :SERIES
    :RESistance
      :MAXimum?
      :MINimum?
    :RESistance?
  :SINK
    :RESistance
      :MAXimum?
      :MINimum?
    :RESistance?
```

```

SOURce
:VOLTage <fval>
:VOLTage
:HIGH
:LImit <NRF>
:LImit
:MAXimum?
:MINimum?
:LImit?
:LOW
:LImit <NRF>
:LImit?
:MAXimum?
:MINimum?
:MONitor
:FSC <NRf>
:FSC?
:PROG
:FSC <fval>
:FSC?
:FSCR <NRf>
:FSCR?
:PROGram <val>
:PROGram
:SOURce
:SOURce?
:PROGram?
:PROTection <val>
:PROTection?
:PROTection
:MAXimum?
:MINimum?
:PROGram <int>
:PROGram
:FSC <NRf>
:FSC?
:PROGram?
:RAMP <startvolt,endvolt,ramptime,HW/SWTrigger>
:RAMP
:ABORT
:SLEW <userdefined|max>
:SLEW?
:STATus?
:RAMP?
:SLEW
:MAXimum?
:MINimum?

```

```

SOURCE
  :VOLTage
    :SLEW?
    :SOFT
      :LIMit
        :HIGH <NRF>
        :HIGH?
        :LOW <NRF>
        :LOW?
  :VOLTage?

```

9.4.2 SOURCE SCPI COMMAND REFERENCE

The letter “C” in the “SCPI” column means that the command syntax is SCPI compliant; an “N” in the “SCPI” column means that the command syntax is not part of the SCPI definition.

COMMAND	DESCRIPTION	SCPI
SOURCE:ANALOG:REMOte:OUTPut <0 1>	Enables or disables the remote output ON/OFF. 0 – enable 1 - disable	N
SOURCE:ANALOG:REMOte:OUTPut?	Returns the setting of remote output ON/OFF.	N
SOURCE:CURREnt <NRF>	Sets the output current in amps.	N
SOURCE:CURREnt?	Returns the output current in amps.	N
SOURCE:CURREnt:MAXimum?	Returns the maximum current device limit.	N
SOURCE:CURREnt:MINimum?	Returns the minimum current device limit.	N
SOURCE:CURREnt:MONitor:FSC <NRF>	Sets Full-scale voltage on Current monitor pin (IMON), when power supply is producing full scale output current.	N
SOURCE:CURREnt:MONitor:FSC?	Returns the full-scale voltage set for Current monitor pin (IMON)	N
SOURCE:CURREnt:NEGative:LIMit <NRF>	Sets the negative current limit in amps. For Example: in CV/CC mode, the current limit value the user should set, so that once the current reaches this value, the output current regulates at this value.	N
SOURCE:CURREnt:NEGative:LIMit?	Returns the negative current limit set in amps.	N
SOURCE:CURREnt:NEGative:LIMit:MAXimum?	Returns the maximum negative current limit the user can set in amps.	N
SOURCE:CURREnt:NEGative:LIMit:MINimum?	Returns the minimum negative current limit the user can set, in amps.	N
SOURCE:CURREnt:POSitive:LIMit <NRF>	Sets the positive current limit in amps. For Example: in CV/CC mode, the current limit value the user should set, so that once the current reaches this value, the output current regulates at this value.	N
SOURCE:CURREnt:POSitive:LIMit?	Returns the positive current limit set in amps.	N

COMMAND	DESCRIPTION	SCPI
SOURce:CURRent:POSitive:LIMit:MAXimum?	Returns the maximum positive current limit the user can set, in amps.	N
SOURce:CURRent:POSitive:LIMit:MINimum?	Returns the minimum positive current limit the user can set, in amps.	N
SOURce:CURRent:PROGram:FSC <NR1>	Sets the Full-Scale voltage, at which Rated Current will be programmed in external Current programming Mode with voltage as programming source. Valid Range is from 5 to 10 V.	N
SOURce:CURRent:PROGram:FSC?	Returns the Full-scale Voltage, at which Rated Current will be programmed.	N
SOURce:CURRent:PROGram:FSCR <NR1>	Sets the Full-Scale resistance, at which Rated Current will be programmed in external Current programming Mode with Current as programming source. Valid Range is from 5 to 10kOhm.	N
SOURce:CURRent:PROGram:FSCR?	Returns the Full-scale Resistance, at which Rated Current will be programmed.	N
SOURce:CURRent:PROTecti on:NEGative?	Returns the negative overcurrent protection value.	N
SOURce:CURRent:PROTecti on:NEGative <NRf>	Sets the negative overcurrent protection value.	N
SOURce:CURRent:PROTecti on:NEGative:MAXimum?	Returns the maximum value of negative overcurrent protection that can be set.	N
SOURce:CURRent:PROTecti on:NEGative:MINimum?	Returns the minimum value of negative overcurrent protection that can be set.	N
SOURce:CURRent:PROTecti on:POSitive <NRf>	Sets the positive overcurrent protection value.	N
SOURce:CURRent:SLEW:MAXimum?	Returns the maximum possible slew rate/time for the current.	N
SOURce:CURRent:PROTecti on:POSitive:MAXimum?	Returns the maximum value of positive overcurrent protection that can be set.	N
SOURce:CURRent:PROTecti on:POSitive:MINimum?	Returns the minimum value of positive overcurrent protection that can be set.	N
SOURce:CURR:RAMP <NRf>, <NRf>, <NRf>, <0 1>	Sets the current ramp parameters <From Current>, <To Current>, <Duration>, <HW/SW Trigger> 0 - SW Trigger 1 - HW Trigger	N
SOURce:CURR:RAMP:ABORT	Aborts ramping and clears trigger mode.	N
SOURce:CURR:RAMP:SLEW <Programmable slew/0 Max slew/1>	Sets the ramp slew type value, rate at which the unit current value reaches to the from current value of the ramp function.	N
SOURce:CURRent:RAMP:SLEW?	Returns the slew setting as 0 (Programmable slew) or 1(Max slew) used for ramp function	N
SOURce:CURR:RAMP?	Returns the current ramp parameters. <From Current>, <To Current>, <Duration>, <HW/SW Trigger>	N

COMMAND	DESCRIPTION	SCPI
SOURce:CURR:RAMP:STATus?	Returns the current ramp status IDLE INITIALIZING, <progress in %> WAITING FOR TRIGGER RUNNING, <progress in %> ABORTED, <aborted at %> COMPLETE	N
SOURce:CURRent:SLEW <NRf>, <NRf>	Sets the slew rate for the output current in A/ms or Sec. <Raising Slew>, <Falling Slew>	N
SOURce:CURRent:SLEW:MAXimum?	Returns the maximum possible slew rate for the current.	N
SOURce:CURRent:SLEW:MINimum?	Returns the minimum possible slew rate for the current.	N
SOURce:CURRent:SLEW?	Returns the slew rate set for current <Raising Slew>, <Falling Slew>.	N
SOURce:CURRent:SOFT:LIMit:HIGH <NRf>	Sets the higher limit for current set value (user limit).	N
SOURce:CURRent:SOFT:LIMit:HIGH?	Returns the higher side of the soft limit for current.	N
SOURce:CURRent:SOFT:LIMit:LOW <NRf>	Sets the lower limit of the current set value (user limit).	N
SOURce:CURRent:SOFT:LIMit:LOW?	Returns the lower side of the soft limit for current.	N
SOURce:CURRent:PROGram <INT/0 EXT/1>	Changes the Current programming mode of the supply. Valid arguments are: INT/0 (Internal SCPI Current programming) EXT/1 (External analog Current programming).	N
SOURce:CURRent:PROGram: SOURce <0 1>	Changes the source for the external analog current programming. Valid arguments are: 0 – (voltage source) 1 – (current source).	N
SOURce:CURRent:PROGram: SOURce?	Returns the selected source for the external analog current programming.	N
SOURce:CURRent:PROGram?	Returns the Current programming mode of the supply.	N
SOURce:DIO:OUT1 <0 1>	Sets the status of digital output 1 at the Remote Analog Programming connector.	N
SOURce:DIO:OUT1?	Returns the status of digital output 1 at the Remote Analog Programming connector.	N
SOURce:DIO:OUT2 <0 1>	Sets the status of digital output 2 at the Remote Analog Programming connector.	N
SOURce:DIO:OUT2?	Returns the status of digital output 2 at the Remote Analog Programming connector.	N
SOURce:EXtErnal:CONTROL:REL1 <0 1>	Changes the position of the external relay 1 if isolation relay is enabled	N

COMMAND	DESCRIPTION	SCPI
SOURce:EXTernal:CONTROL:REL1?	Returns the position of the external relay 1	N
SOURce:EXTernal:CONTROL:REL2 <0 1>	Changes the position of the external relay 2	N
SOURce:EXTernal:CONTROL:REL2?	Returns the position of the external relay 2	N
SOURce:POWer <NRf>	Sets the maximum power limit.	N
SOURce:POWer:MAXimum?	Returns the Maximum power device limit.	N
SOURce:POWer:MINimum?	Returns the Minimum power device limit.	N
SOURce:POWer:NEGative:LIMit <NRf>	Sets the negative power limit. For Example: In CC/CP mode, the maximum value that can be set for the output power to regulate.	N
SOURce:POWer:NEGative:LIMit?	Returns the negative power limit.	N
SOURce:POWer:NEGative:LIMit:MAXimum?	Returns the maximum value that the user can set for negative power limit.	N
SOURce:POWer:NEGative:LIMit:MINimum?	Returns the minimum value that the user can set for negative power limit.	N
SOURce:POWer:POSitive:LIMit <NRf>	Sets the positive power limit. For Example: In CP/CC mode, the maximum value that can be set for the output power to regulate.	N
SOURce:POWer:POSitive:LIMit?	Returns the positive power limit.	N
SOURce:POWer:POSitive:LIMit:MAXimum?	Returns the maximum value that the user can set for positive power limit.	N
SOURce:POWer:POSitive:LIMit:MINimum?	Returns the minimum value that the user can set for positive power limit.	N
SOURce:POWer:SOFT:LIMit:HIGH <NRf>	Sets the higher side of soft limit for power set value (User Limit).	N
SOURce:POWer:SOFT:LIMit:HIGH?	Returns the higher side soft limit for power.	N
SOURce:POWer:SOFT:LIMit:LOW <NRf>	Sets the lower side of soft limit for power set value (User Limit).	N
SOURce:POWer:SOFT:LIMit:LOW?	Returns the lower side of soft limit for power.	N
SOURce:POWer?	Returns the power value set by the user.	N
SOURce:SERIES:RESISTANCE <NRf>	Sets the value for series resistance.	N
SOURce:SERIES:RESISTANCE:MAXimum?	Returns the maximum possible value for series resistance.	N
SOURce:SERIES:RESISTANCE:MINimum?	Returns the minimum possible value for series resistance.	N
SOURce:SERIES:RESISTANCE?	Returns the value for series resistance.	N

COMMAND	DESCRIPTION	SCPI
SOURce:VOLTage <Nrf>	Sets the output voltage to be regulated.	N
SOURce:VOLTage:HIGH:LIMit <Nrf>	Sets the higher limit of voltage. For Example: In CC/CV mode, the higher side voltage to be regulated once the output voltage reaches this value.	N
SOURce:VOLTage:HIGH:LIMit:MAXimum?	Returns the maximum possible value for higher side of the output voltage.	N
SOURce:VOLTage:HIGH:LIMit:MINimum?	Returns the minimum possible value for higher side of the output voltage.	N
SOURce:VOLTage:HIGH:LIMit?	Returns the higher side voltage limit value set by the user.	N
SOURce:VOLTage:LOW:LIMit <Nrf>	Sets the lower limit of voltage. For Example: In CC/CV mode, the lower side voltage to be regulated once the output voltage reaches this value.	N
SOURce:VOLTage:LOW:LIMit?	Returns the lower side voltage limit value set by the user.	N
SOURce:VOLTage:MAXimum?	Returns the maximum voltage of the unit.	N
SOURce:VOLTage:MINimum?	Returns the minimum voltage of the unit.	N
SOURce:VOLTage:MONitor:FSC <Nrf>	Sets Full-scale voltage on voltage monitor pin (VMON), when power supply is producing full scale output voltage.	N
SOURce:VOLTage:MONitor:FSC?	Returns the full-scale voltage set for Voltage monitor pin (VMON)	N
SOURce:VOLTage:PROG:FSC <Nrf>	Sets the Full-scale voltage, at which Rated Voltage will be programmed in external Voltage programming Mode with voltage as programming source. Valid Range is from 5 to 10V.	N
SOURce:VOLTage:PROG:FSC?	Returns the Full-scale Voltage, at which Rated Voltage will be programmed.	N
SOURce:VOLTage:PROG:FSC R <Nrf>	Sets the Full-scale resistance, at which Rated Voltage will be programmed in external Voltage programming Mode with Current as programming source. Valid Range is from 5 to 10kOhm.	N
SOURce:VOLTage:PROG:FSC R?	Returns the Full-scale Resistance, at which Rated Voltage will be programmed.	N
SOURce:VOLTage:PROGRAM <0 1>	Changes the Voltage programming mode of the supply. Valid arguments are: INT/0 (Internal SCPI Voltage programming) EXT/1 (External analog Voltage programming).	N
SOURce:VOLTage:PROGram: SOURce <0 1>	Changes the source for the external analog voltage programming. Valid arguments are: 0 – (voltage source) 1 – (Current source).	N
SOURce:VOLTage:PROGram: SOURce?	Returns the selected source for the external analog voltage programming.	N

COMMAND	DESCRIPTION	SCPI
SOURce:VOLTage:PROGRAM?	Returns the setting of Voltage programming mode.	N
SOURce:VOLTage:PROTection <Nrf>	Sets the overvoltage protection trip point in volts.	N
SOURce:VOLTage:PROTection?	Returns the set overvoltage protection trip point in volts.	N
SOURce:VOLTage:PROTection:MAXimum?	Returns the maximum possible value for setting overvoltage protection limit.	N
SOURce:VOLTage:PROTection:MINimum?	Returns the minimum possible value for setting overvoltage protection limit.	N
SOURce<n>:VOLTage:PROTection:PROGram <0/int 1/ext>	Changes the Overvoltage programming mode of the supply. Valid arguments are: INT/0 (Internal Digital Voltage programming) EXT/1 (External analog Voltage programming).	N
SOURce:VOLTage:PROTection:PROGram?	Returns the setting of Overvoltage programming mode.	N
SOURce:VOLTage:PROTection:PROGram:FSC <Nrf>	Sets the Full-scale voltage, at which Rated Overvoltage will be programmed in external Overvoltage programming Mode with voltage as programming source. Valid Range is from 5 to 10V.	N
SOURce:VOLTage:PROTection:PROGram:FSC?	Returns the Full-scale Voltage, at which Rated Overvoltage will be programmed.	N
SOURce:VOLTage:PROTection:PROGram?	Returns the setting of Overvoltage programming mode.	N
SOURce:VOLTage:RAMP <Nrf>, <Nrf>, <Nrf>, <0 1>	Sets the voltage ramp parameters <From Voltage>, <To Voltage>, <Duration>, <HW/SW Trigger> 0 - SW Trigger 1 - HW Trigger	N
SOURce:VOLTage:RAMP:ABORT	Aborts ramping and clears trigger mode.	N
SOURce:VOLTage:RAMP:SLEW <Programmable slew/0 Max slew/1>	Changes the Ramp slew configuration, Valid arguments are: 0 - Programmable slew 1 - Max slew	N
SOURce:VOLTage:RAMP:SLEW?	Returns the Ramp Slew configuration	N
SOURce:VOLTage:RAMP:status?	Returns the voltage ramp status IDLE INITIALIZING, <progress in %> WAITING FOR TRIGGER RUNNING, <progress in %> ABORTED, <aborted at %> COMPLETE	N

COMMAND	DESCRIPTION	SCPI
SOURce:VOLTage:RAMP?	Returns voltage ramp configuration parameters: <From Voltage>, <To Voltage>, <Duration>, <HW/SW Trigger>	N
SOURce:VOLTage:SLEW <NRf>, <NRf>	Sets the slew rate for the output voltage in V/ms (first argument) or seconds (second argument).	N
SOURce:VOLTage:SLEW:MAXimum?	Returns the maximum slew rate possible for output voltage.	N
SOURce:VOLTage:SLEW:MINimum?	Returns the minimum slew rate possible for output voltage.	N
SOURce:VOLTage:SLEW?	Returns the slew rate for the output voltage.	N
SOURce:VOLTage:SOFT:LIMit:HIGH <NRf>	Sets the maximum soft limit for the output voltage (user limit).	N
SOURce:VOLTage:SOFT:LIMit:HIGH?	Returns the maximum soft limit for the output voltage.	N
SOURce:VOLTage:SOFT:LIMit:LOW <NRf>	Sets the minimum soft limit for the output voltage (user limit).	N
SOURce:VOLTage:SOFT:LIMit:LOW?	Returns the minimum soft limit for the output voltage.	N
SOURce:VOLTage?	Returns the set voltage value.	N

Table 9-7. Source SCPI Command Reference

9.5 PVSIM SCPI COMMAND SYSTEM

This section first presents a tree summary of the PVSIM commands and then provides a tabular description.

9.5.1 PVSIM SCPI COMMAND SUMMARY

```

SASimulator
  :CURVe
    :ADD
    :CATalogue?
    :DATA
      :CURRent
      :CURRent?
      :VOLTage
      :VOLTage?
    :INDEX
    :INDEX?
  :DELeTe
  :EN50530

```

```
SASimulator
:CURVe
:EN50530
:COEFFicients
:ALPHA
:MAXimum?
:MINimum?
:ALPHA?
:BETA
:MAXimum?
:MINimum?
:BETA?
:CG
:MAXimum?
:MINimum?
:CG?
:CR
:MAXimum?
:MINimum?
:CR?
:CV
:MAXimum?
:MINimum?
:CV?
:DEFaults
:FFI
:MAXimum?
:MINimum?
:FFI?
:FFU
:MAXimum?
:MINimum?
:FFU?
:VL2H
:MAXimum?
:MINimum?
:VL2H?
:MPPparams
:PMP
:MAXimum?
:MINimum?
:PMP?
:VMP
:MAXimum?
:MINimum?
:VMP?
```

```

SASimulator
  :CURVe
    :EN50530
      :SIMtype
        :TECHnology
        :TECHnology?
        :TESTtype
        :TESTtype?
      :SAVE
      :SElect
      :SElect?
      :SNL
        :BETAprams
          :P
            :MAXimum?
            :MINimum?
          :P?
          :V
            :MAXimum?
            :MINimum?
          :V?
        :FILLfactor
          :MAXimum?
          :MINimum?
          :STATE
          :STATE?
        :FILLfactor?
        :Kfactor
          :IRRadance
            :MAXimum?
            :MINimum?
          :IRRadance?
          :VOLTage
            :MAXimum?
            :MINimum?
          :VOLTage?
        :MPPparams
          :IMP
            :MAXimum?
            :MINimum?
          :IMP?
          :VMP
            :MAXimum?
            :MINimum?
          :VMP?
        :VIparams
          :ISC
            :MAXimum?
            :MINimum?

```

```

:ISC?
SASimulator
:CURVe
:SNL
:VIparams
:VOC
:MAXimum?
:MINimum?
:VOC?

:TYPE
:TYPE?
:MPP?
:OPERating
:MODE
:MODE?
:TYPE
:TYPE?
:PMP?
:SOURce
:EN50530
:POWer
:MAXimum?
:MINimum?
:POWer?
:SIMtype
:TECHnology
:TECHnology?
:TESTtype
:TESTtype?
:VOLTage
:MAXimum?
:MINimum?
:VOLTage?
:IRRadiance
:MAXimum?
:MINimum?
:IRRadiance?
:TEMPerature
:MAXimum?
:MINimum?
:TEMPerature?
:LOAD
:LOAD?
:STATUS?

```

9.5.2 PVSIM SCPI COMMAND REFERENCE

The letter “C” in the “SCPI” column means that the command syntax is SCPI compliant; an “N” in the “SCPI” column means that the command syntax is not part of the SCPI definition.

COMMAND	DESCRIPTION	SCPI
SASimulator:CURVe:ADD <string>	Creates the curve with provided file name in the selected curve type and operation type, mode, alphanumeric string	N
SASimulator:CURVe:CATalog ue?	Returns the curves present in selected SAS configuration	N
SASimulator:CURVe:DATA:VO LTage <NRf>, <NRf>, . . . , <NRf>	Sets the 1024 Voltage points of the selected IV Curve in the User Defined curve type in volts	N
SASimulator:CURVe:DATA:VO LTage?	Returns the 1024 Voltage points of Selected IV Curve in the User Defined curve type in volts	N
SASimulator:CURVe:DATA:CU RRent <NRf>, <NRf>, . . . , <NRf>	Sets the 1024 Current point of the selected IV Curve in the User Defined Curve type in amps	N
SASimulator:CURVe:DATA:CU RRent?	Returns the 1024 current points of the selected IV Curve in the User Defined Curve type in amps	N
SASimulator:CURVe:DATA:IN DEX <NR1>	Sets the Index value to get the next 25 points of IV Curve	N
SASimulator:CURVe:DATA:IN DEX?	Returns the Index value to get the next 25 points of IV Curve	N
SASimulator:CURVe:DELeTe	Deletes the selected IV Curve	N
SASimulator:CURVe:EN50530 :COEFFicients:ALPha <NRf>	Sets the ALPHA value in the EN50530 Curve	N
SASimulator:CURVe:EN50530 :COEFFicients:ALPha:MAXim um?	Returns the maximum ALPHA value that can be set	N
SASimulator:CURVe:EN50530 :COEFFicients:ALPha:MINim um?	Returns the minimum APLPA value that can be set	N
SASimulator:CURVe:EN50530 :COEFFicients:ALPha?	Returns the ALPHA Value of the EN50530 Curve	N
SASimulator:CURVe:EN50530 :COEFFicients:BEtA <NRf>	Sets the BETA value in the EN50530 Curve	N
SASimulator:CURVe:EN50530 :COEFFicients:BEtA:MAXimu m?	Returns the maximum BETA value that can be set	N
SASimulator:CURVe:EN50530 :COEFFicients:BEtA:MINimu m?	Returns the minimum BETA value that can be set	N

COMMAND	DESCRIPTION	SCPI
SASimulator:CURVe:EN50530:COEFFicients:BEtA?	Returns the BETA Value of the EN50530 Curve	N
SASimulator:CURVe:EN50530:COEFFicients:CG <NRf>	Sets the CG value in the selected EN50530 Curve	N
SASimulator:CURVe:EN50530:COEFFicients:CG:MAXimum?	Returns the maximum CG value that can be set	N
SASimulator:CURVe:EN50530:COEFFicients:CG:MINimum?	Returns the minimum CG value that can be set	N
SASimulator:CURVe:EN50530:COEFFicients:CR <NRf>	Sets the CR value in the EN50530 Curve	N
SASimulator:CURVe:EN50530:COEFFicients:CR:MAXimum?	Returns the maximum CR value that can be set	N
SASimulator:CURVe:EN50530:COEFFicients:CR:MINimum?	Returns the minimum CR value that can be set	N
SASimulator:CURVe:EN50530:COEFFicients:CR?	Returns the CR Value of the EN50530 Curve	N
SASimulator:CURVe:EN50530:COEFFicients:CV <NRf>	Sets the CV value in the EN50530 Curve	N
SASimulator:CURVe:EN50530:COEFFicients:CV:MAXimum?	Returns the maximum CV value that can be set	N
SASimulator:CURVe:EN50530:COEFFicients:CV:MINimum?	Returns the minimum CV value that can be set	N
SASimulator:CURVe:EN50530:COEFFicients:CG?	Returns the CV Value of the EN50530 Curve	N
SASimulator:CURVe:EN50530:COEFFicients:DEFaults	Sets the default values to the coefficients with respect to the technology type in EN50530 Curve	N
SASimulator:CURVe:EN50530:COEFFicients:FFI <NRf>	Sets the FFI value in the EN50530 Curve	N
SASimulator:CURVe:EN50530:COEFFicients:FFI:MAXimum?	Returns the maximum FFI value that can be set	N
SASimulator:CURVe:EN50530:COEFFicients:FFI:MINimum?	Returns the minimum FFI value that can be set	N
SASimulator:CURVe:EN50530:COEFFicients:FFI?	Returns the FFI Value of the EN50530 Curve	N
SASimulator:CURVe:EN50530:COEFFicients:FFU <NRf>	Sets the FFU value in the EN50530 Curve	N
SASimulator:CURVe:EN50530:COEFFicients:FFU:MAXimum?	Returns the maximum FFU value that can be set	N

COMMAND	DESCRIPTION	SCPI
SASimulator:CURVe:EN50530:COEFFicients:FFU:MINimum?	Returns the minimum FFU value that can be set	N
SASimulator:CURVe:EN50530:COEFFicients:FFU?	Returns the FFU Value of the EN50530 Curve	N
SASimulator:CURVe:EN50530:COEFFicients:VL2H <Nrf>	Sets the VL2H value in the EN50530 Curve	N
SASimulator:CURVe:EN50530:COEFFicients:VL2H:MAXimum?	Returns the maximum VL2H value that can be set	N
SASimulator:CURVe:EN50530:COEFFicients:VL2H:MINimum?	Returns the minimum VL2H value that can be set	N
SASimulator:CURVe:EN50530:COEFFicients:VL2H?	Returns the VL2H Value of the EN50530 Curve	N
SASimulator:CURVe:EN50530:MPPparams:Pmp <Nrf>	Sets the Power at maximum power point of EN50530 Curve in kW	N
SASimulator:CURVe:EN50530:MPPparams:Pmp:MAXimum?	Returns the maximum power value of maximum power point that can be set in kW	N
SASimulator:CURVe:EN50530:MPPparams:Pmp:MINimum?	Returns the minimum power value of maximum power point that can be set in kW	N
SASimulator:CURVe:EN50530:MPPparams:Pmp?	Returns the Power at maximum power point of EN50530 Curve in kW	N
SASimulator:CURVe:EN50530:MPPparams:Vmp <Nrf>	Sets the Voltage at maximum power point of EN50530 Curve in kW	N
SASimulator:CURVe:EN50530:MPPparams:Vmp:MAXimum?	Returns the maximum Voltage value of maximum power point that can be set in volts	N
SASimulator:CURVe:EN50530:MPPparams:Vmp:MINimum?	Returns the minimum Voltage value of maximum power point that can be set in volts	N
SASimulator:CURVe:EN50530:MPPparams:Vmp?	Returns the Voltage at maximum power point of EN50530 Curve in volts	N
SASimulator:CURVe:EN50530:SIMtype:TECHnology <CSI/0 ThinFlim/1>	Sets the Technology type of the EN50530 curve	N
SASimulator:CURVe:EN50530:SIMtype:TECHnology?	Returns the technology type of the EN50530 Curve 0 – CSI 1 – Thin Film	N
SASimulator:CURVe:EN50530:SIMtype:TESTtype <Static/0 Dynamic/1>	Sets the test type of the EN50530 Curve	N
SASimulator:CURVe:EN50530:SIMtype:TESTtype?	Returns the Test type of the EN50530 Curve 0 – Static 1 – Dynamic	N
SASimulator:CURVe:SAVE	Saves the selected IV Curve	N

COMMAND	DESCRIPTION	SCPI
SASimulator:CURVe:SElect <string>	Selects the curve with provided file name.	N
SASimulator:CURVe:SElect?	Returns the File name of the selected IV Curve	N
SASimulator:CURVe:SNL:BET Aparams:P <NRf>	Sets the BETA P Value to Selected SNL Curve	N
SASimulator:CURVe:SNL:BET Aparams:P:MAXimum?	Returns the maximum BETA P Value that can be set	N
SASimulator:CURVe:SNL:BET Aparams:P:MINimum?	Returns the minimum BETA P Value that can be set	N
SASimulator:CURVe:SNL:BET Aparams:P?	Returns the BETA P of the Selected SNL Curve	N
SASimulator:CURVe:SNL:BET Aparams:V <NRf>	Sets the BETA V Value to Selected SNL Curve	N
SASimulator:CURVe:SNL:BET Aparams:V:MAXimum?	Returns the maximum BETA V Value that can be set	N
SASimulator:CURVe:SNL:BET Aparams:V:MINimum?	Returns the minimum BETA V Value that can be set	N
SASimulator:CURVe:SNL:BET Aparams:V?	Returns the BETA V Value of the Selected SNL Curve	N
SASimulator:CURVe:SNL:FIL Lfactor <NRf>	Sets the Fill Factor Value to Selected SNL Curve	N
SASimulator:CURVe:SNL:FIL Lfactor:MAXimum?	Returns the maximum Fill Factor Value that can be set	N
SASimulator:CURVe:SNL:FIL Lfactor:MINimum?	Returns the minimum Fill Factor Value that can be set	N
SASimulator:CURVe:SNL:FIL Lfactor:STATe <Boolean>	Sets the state of the Fill Factor to the SNL Curve 0 - Fill Factor Value provided is not considered 1 – Fill Factor Value provided is considered	N
SASimulator:CURVe:SNL:FIL Lfactor:STATe?	Returns the State of the Fill Factor in the Selected SNL Curve. <0 1>	N
SASimulator:CURVe:SNL:FIL Lfactor?	Returns the Fill Factor Value of the Selected SNL Curve	N
SASimulator:CURVe:SNL:Kfa ctor:IRRadiance <NRf>	Sets the KFactor Irradiance Value to Selected SNL Curve	N
SASimulator:CURVe:SNL:Kfa ctor:IRRadiance:MAXimum?	Returns the maximum KFactor Irradiance Value that can be set	N
SASimulator:CURVe:SNL:Kfa ctor:IRRadiance:MINimum?	Returns the minimum KFactor Irradiance Value that can be set	N
SASimulator:CURVe:SNL:Kfa ctor:IRRadiance?	Returns the KFactor Irradiance Value of the Selected SNL Curve	N
SASimulator:CURVe:SNL:Kfa ctor:VOLTagE <NRf>	Sets the KFactor Voltage Value to Selected SNL Curve	N
SASimulator:CURVe:SNL:Kfa ctor:VOLTagE:MAXimum?	Returns the maximum KFactor Voltage Value that can be set in	N

COMMAND	DESCRIPTION	SCPI
SASimulator:CURVe:SNL:Kfactor:VOLTagE:MINimum?	Returns the minimum KFactor Voltage Value that can be set	N
SASimulator:CURVe:SNL:Kfactor:VOLTagE?	Returns the KFactor Voltage Value of the Selected SNL Curve	N
SASimulator:CURVe:SNL:MPPparams:Imp <Nrf>	Sets the Current at Maximum power point to Selected SNL Curve	N
SASimulator:CURVe:SNL:MPPparams:Imp:MAXimum?	Returns the Maximum Current Value at maximum power point in the SNL Curve type that can be set in amps	N
SASimulator:CURVe:SNL:MPPparams:Imp:MINimum?	Returns the Minimum Current Value at maximum power point in the SNL Curve type that can be set in amps	N
SASimulator:CURVe:SNL:MPPparams:Imp?	Returns the Current at Maximum power point of Selected SNL Curve in amps	N
SASimulator:CURVe:SNL:MPPparams:Vmp <Nrf>	Sets the Voltage at Maximum power point to Selected SNL Curve in volts	N
SASimulator:CURVe:SNL:MPPparams:Vmp:MAXimum?	Returns the Maximum Voltage Value at maximum power point in the SNL Curve type that can be set in volts	N
SASimulator:CURVe:SNL:MPPparams:Vmp:MINimum?	Returns the Minimum Voltage Value at maximum power point in the SNL Curve type that can be set in volts	N
SASimulator:CURVe:SNL:MPPparams:Vmp?	Returns the Voltage at Maximum power point of Selected SNL Curve in volts	N
SASimulator:CURVe:SNL:VIparams:Isc <Nrf>	Sets the Short Circuit Current to Selected SNL Curve in amps	N
SASimulator:CURVe:SNL:VIparams:Isc:MAXimum?	Returns the Maximum Short Circuit Current in the SNL Curve type that can be set in amps	N
SASimulator:CURVe:SNL:VIparams:Isc:MINimum?	Returns the Minimum Short Circuit current in the SNL Curve type that can be set in amps	N
SASimulator:CURVe:SNL:VIparams:Isc?	Returns the Short Circuit Current of Selected SNL Curve in amps	N
SASimulator:CURVe:SNL:VIparams:Voc <Nrf>	Sets the Open Circuit Voltage Selected SNL Curve in volts	N
SASimulator:CURVe:SNL:VIparams:Voc:MAXimum?	Returns the Maximum Open Circuit Voltage in the SNL Curve type that can be set in volts	N
SASimulator:CURVe:SNL:VIparams:Voc:MINimum?	Returns the Minimum Open Circuit voltage in the SNL Curve type that can be set in volts	N
SASimulator:CURVe:SNL:VIparams:Voc?	Returns the Open Circuit Voltage of Selected SNL Curve in volts	N
SASimulator:CURVe:TYPE <SNL/0 EN50530/1 Userdefined VI points/2>	Sets the Operating Curve type of the PV Simulator	N
SASimulator:CURVe:TYPE?	Returns the Selected curve type of PV Simulator 0 – SNL	N

COMMAND	DESCRIPTION	SCPI
	1 – EN50530 3 – User Defined Curve	
SASimulator:MPP?	Returns the MPPT Tracking efficiency of the UUT	N
SASimulator:OPERATING:MODE <Standard/0 Array/1>	Sets the Operating mode of the Curve type	N
SASimulator:OPERATING:MODE?	Returns the Selected operating mode of the curve type 0 – Standard 1 – Array	N
SASimulator:OPERATING:TYPE <Steadystate/0 profiles/1>	Sets the Operating type of the Selected Operating mode that PV Simulator operates	N
SASimulator:CURVe:TYPE?	Returns the operating type of the Selected Operating mode	N
SASimulator:PMP?	Returns the Calculated Maximum power at Maximum power point of Selected IV Curve in kW	N
SASimulator:SOURce:EN50530:POWer <Nrf>	Sets the Rated Power of Selected EN50530 Curve in kW	N
SASimulator:SOURce:EN50530:POWer:MAXimum?	Returns the Maximum Rated power Value that can be set in the EN50530 Curve in kW	N
SASimulator:SOURce:EN50530:POWer:MINimum?	Returns the Minimum Rated Power Value that can be sets in the EN50530 Curve in kW	N
SASimulator:SOURce:EN50530:POWer?	Returns the Rated Power Value of the selected EN50530 Curve in kW	N
SASimulator:SOURce:EN50530:SIMtype:TECHnology <CSI/0 ThinFlim/1>	Sets the Technology of the Selected EN50530 Curve	N
SASimulator:SOURce:EN50530:SIMtype:TECHnology?	Returns the Technology type of the EN50530 curve 0 – CSI Type 1 – Thin Film type	N
SASimulator<n>:SOURce:EN50530:SIMtype:TESTtype <Static/0 Dynamic/1>	Sets the Test Type of the EN50530 Curve	N
SASimulator<n>:SOURce:EN50530:SIMtype:TESTtype?	Returns the Test type of the EN50530 Curve 0 – Static 1 – Dynamic	N
SASimulator:SOURce:EN50530:VOLTage<Nrf>	Sets the Rated Voltage Value of the EN50530 Curve in volts	N
SASimulator:SOURce:EN50530:VOLTage:MAXimum?	Returns the Maximum Rated Voltage Value that can be set in the EN50530 Curve in volts	N
SASimulator:SOURce:EN50530:VOLTage:MINimum?	Returns the Minimum Rated Voltage Value that can be sets in the EN50530 Curve in volts	N
SASimulator:SOURce:EN50530:VOLTage?	Returns the Rated Voltage value of the selected EN50530 Curve in volts	N

COMMAND	DESCRIPTION	SCPI
SASimulator:SOURce:IRRadiance <NRf>	Sets the Irradiance of the Selected IV Curve	N
SASimulator:SOURce:IRRadiance:MAXimum?	Returns the Maximum Irradiance Value that can be set to the Curve	N
SASimulator:SOURce:IRRadiance:MINimum?	Returns the Minimum Irradiance Value that can be set to the curve	N
SASimulator:SOURce:IRRadiance?	Returns the Irradiance value of the selected Curve	N
SASimulator:SOURce:TEMPerature <NRf>	Sets the Temperature of the Selected IV Curve	N
SASimulator:SOURce:TEMPerature:MAXimum?	Returns the Maximum Temperature Value that can be set to the Curve	N
SASimulator:SOURce:TEMPerature:MINimum?	Returns the Minimum Temperature Value that can be set to the curve	N
SASimulator:SOURce:TEMPerature?	Returns the Temperature value of the selected Curve	N
SASimulator:STATUS?	Returns the status of the PV Simulator 0 – IDLE 1 – INITIALIZING 2 – INITIALIZED 3 – RUNNING 5 – ABORTED 6 – PAUSED 7 - TRIPPED	N
SASimulator:LOAD <0 1>	Loads the Selected IV Curve to PV Simulator 0 – Unloads the IV Curve 1 – Loads the Selected IV Curve	N
SASimulator:LOAD?	Returns the load status of the selected IV Curve to the PV Simulator 0 – Not Loaded 1 – Loaded	N
SASimulator:CLIPPED?	Return IV Curve status as CLIPPED – Curve is clipped, NOT CLIPPED – Curve is Not Clipped	N
SASimulator:CURVe:ADD <string>	Creates the curve with provided file name in the selected curve type and operation type, mode, alphanumeric string	N
SASimulator:CURVe:CATalogue?	Returns the curves present in selected SAS configuration	N
SASimulator:CURVe:DATA:VOLtage <NRf>, <NRf>, . . . , <NRf>	Sets the 1024 Voltage points of the selected IV Curve in the User Defined curve type in volts	N
SASimulator:CURVe:DATA:VOLtage?	Returns the 1024 Voltage points of Selected IV Curve in the User Defined curve type in volts	N
SASimulator:CURVe:DATA:CURRent	Sets the 1024 Current point of the selected IV Curve in the User Defined Curve type in amps	N

COMMAND	DESCRIPTION	SCPI
<NRf>, <NRf>, ..., <NRf>		
SASimulator:CURVe:DATA:CURRent?	Returns the 1024 current points of the selected IV Curve in the User Defined Curve type in amps	N
SASimulator:CURVe:DELeTe	Deletes the selected IV Curve	N
SASimulator:CURVe:EN50530:COEFFicients:ALPha <NRf>	Sets the ALPHA value in the EN50530 Curve	N
SASimulator:CURVe:EN50530:COEFFicients:ALPha:MAXimum?	Returns the maximum ALPHA value that can be set	N
SASimulator:CURVe:EN50530:COEFFicients:ALPha:MINimum?	Returns the minimum ALPHA value that can be set	N
SASimulator:CURVe:EN50530:COEFFicients:ALPha?	Returns the ALPHA Value of the EN50530 Curve	N
SASimulator:CURVe:EN50530:COEFFicients:BEtA <NRf>	Sets the BETA value in the EN50530 Curve	N
SASimulator:CURVe:EN50530:COEFFicients:BEtA:MAXimum?	Returns the maximum BETA value that can be set	N
SASimulator:CURVe:EN50530:COEFFicients:BEtA:MINimum?	Returns the minimum BETA value that can be set	N
SASimulator:CURVe:EN50530:COEFFicients:BEtA?	Returns the BETA Value of the EN50530 Curve	N
SASimulator:CURVe:EN50530:COEFFicients:CG <NRf>	Sets the CG value in the selected EN50530 Curve	N
SASimulator:CURVe:EN50530:COEFFicients:CG:MAXimum?	Returns the maximum CG value that can be set	N
SASimulator:CURVe:EN50530:COEFFicients:CG:MINimum?	Returns the minimum CG value that can be set	N
SASimulator:CURVe:EN50530:COEFFicients:CG?	Returns the CG Value of the EN50530 Curve	N
SASimulator:CURVe:EN50530:COEFFicients:CR <NRf>	Sets the CR value in the EN50530 Curve	N
SASimulator:CURVe:EN50530:COEFFicients:CR:MAXimum?	Returns the maximum CR value that can be set	N
SASimulator:CURVe:EN50530:COEFFicients:CR:MINimum?	Returns the minimum CR value that can be set	N
SASimulator:CURVe:EN50530:COEFFicients:CR?	Returns the CR Value of the EN50530 Curve	N
SASimulator:CURVe:EN50530:COEFFicients:CV <NRf>	Sets the CV value in the EN50530 Curve	N
SASimulator:CURVe:EN50530:COEFFicients:CV:MAXimum?	Returns the maximum CV value that can be set	N

COMMAND	DESCRIPTION	SCPI
SASimulator:CURVe:EN50530:COEFFicients:CV:MINimum?	Returns the minimum CV value that can be set	N
SASimulator:CURVe:EN50530:COEFFicients:CG?	Returns the CV Value of the EN50530 Curve	N
SASimulator:CURVe:EN50530:COEFFicients:DEFAULTS	Sets the default values to the coefficients with respect to the technology type in EN50530 Curve	N
SASimulator:CURVe:EN50530:COEFFicients:FFI <Nrf>	Sets the FFI value in the EN50530 Curve	N
SASimulator:CURVe:EN50530:COEFFicients:FFI:MAXimum?	Returns the maximum FFI value that can be set	N
SASimulator:CURVe:EN50530:COEFFicients:FFI:MINimum?	Returns the minimum FFI value that can be set	N
SASimulator:CURVe:EN50530:COEFFicients:FFI?	Returns the FFI Value of the EN50530 Curve	N
SASimulator:CURVe:EN50530:COEFFicients:FFU <Nrf>	Sets the FFU value in the EN50530 Curve	N
SASimulator:CURVe:EN50530:COEFFicients:FFU:MAXimum?	Returns the maximum FFU value that can be set	N
SASimulator:CURVe:EN50530:COEFFicients:FFU:MINimum?	Returns the minimum FFU value that can be set	N
SASimulator:CURVe:EN50530:COEFFicients:FFU?	Returns the FFU Value of the EN50530 Curve	N
SASimulator:CURVe:EN50530:COEFFicients:VL2H <Nrf>	Sets the VL2H value in the EN50530 Curve	N
SASimulator:CURVe:EN50530:COEFFicients:VL2H:MAXimum??	Returns the maximum VL2H value that can be set	N
SASimulator:CURVe:EN50530:COEFFicients:VL2H:MINimum?	Returns the minimum VL2H value that can be set	N
SASimulator:CURVe:EN50530:COEFFicients:VL2H?	Returns the VL2H Value of the EN50530 Curve	N
SASimulator:CURVe:EN50530:MPPparams:Pmp <Nrf>	Sets the Power at maximum power point of EN50530 Curve in kW	N
SASimulator:CURVe:EN50530:MPPparams:Pmp:MAXimum?	Returns the maximum power value of maximum power point that can be set in kW	N
SASimulator:CURVe:EN50530:MPPparams:Pmp:MINimum?	Returns the minimum power value of maximum power point that can be set in kW	N
SASimulator:CURVe:EN50530:MPPparams:Pmp?	Returns the Power at maximum power point of EN50530 Curve in kW	N
SASimulator:CURVe:EN50530:MPPparams:Vmp <Nrf>	Sets the Voltage at maximum power point of EN50530 Curve in kW	N

COMMAND	DESCRIPTION	SCPI
SASimulator:CURVe:EN50530:MPPparams:Vmp:MAXimum?	Returns the maximum Voltage value of maximum power point that can be set in volts	N
SASimulator:CURVe:EN50530:MPPparams:Vmp:MINimum?	Returns the minimum Voltage value of maximum power point that can be set in volts	N
SASimulator:CURVe:EN50530:MPPparams:Vmp?	Returns the Voltage at maximum power point of EN50530 Curve in volts	N
SASimulator:CURVe:EN50530:SIMtype:TECHnology<CSI/0 ThinFlim/1>	Sets the Technology type of the EN50530 curve	N
SASimulator:CURVe:EN50530:SIMtype:TECHnology?	Returns the technology type of the EN50530 Curve 0 – CSI 1 – Thin Film	N
SASimulator:CURVe:EN50530:SIMtype:TESTtype<Static/0 Dynamic/1>	Sets the test type of the EN50530 Curve	N
SASimulator:CURVe:EN50530:SIMtype:TESTtype?	Returns the Test type of the EN50530 Curve 0 – Static 1 – Dynamic	N
SASimulator:CURVe:SAVE	Saves the selected IV Curve	N
SASimulator:CURVe:SElect<string>	Selects the curve with provided file name.	N
SASimulator:CURVe:SElect?	Returns the File name of the selected IV Curve	N
SASimulator:CURVe:SNL:BET Aparams:P <NRf>	Sets the BETA P Value to Selected SNL Curve	N
SASimulator:CURVe:SNL:BET Aparams:P:MAXimum?	Returns the maximum BETA P Value that can be set	N
SASimulator:CURVe:SNL:BET Aparams:P:MINimum?	Returns the minimum BETA P Value that can be set	N
SASimulator:CURVe:SNL:BET Aparams:P?	Returns the BETA P of the Selected SNL Curve	N
SASimulator:CURVe:SNL:BET Aparams:V <NRf>	Sets the BETA V Value to Selected SNL Curve	N
SASimulator:CURVe:SNL:BET Aparams:V:MAXimum?	Returns the maximum BETA V Value that can be set	N
SASimulator:CURVe:SNL:BET Aparams:V:MINimum?	Returns the minimum BETA V Value that can be set	N
SASimulator:CURVe:SNL:BET Aparams:V?	Returns the BETA V Value of the Selected SNL Curve	N
SASimulator:CURVe:SNL:FIL Lfactor <NRf>	Sets the Fill Factor Value to Selected SNL Curve	N
SASimulator:CURVe:SNL:FIL Lfactor:MAXimum?	Returns the maximum Fill Factor Value that can be set	N
SASimulator:CURVe:SNL:FIL Lfactor:MINimum?	Returns the minimum Fill Factor Value that can be set	N

COMMAND	DESCRIPTION	SCPI
SASimulator:CURVe:SNL:FiLLfactor:STATE <Boolean>	Sets the state of the Fill Factor to the SNL Curve 0 – Fill Factor Value provided is not considered 1 – Fill Factor Value provided is considered	N
SASimulator:CURVe:SNL:FiLLfactor:STATE?	Returns the State of the Fill Factor in the Selected SNL Curve. <0 1>	N
SASimulator:CURVe:SNL:FiLLfactor?	Returns the Fill Factor Value of the Selected SNL Curve	N
SASimulator:CURVe:SNL:Kfactor:IRRadance <Nrf>	Sets the KFactor Irradiance Value to Selected SNL Curve	N
SASimulator:CURVe:SNL:Kfactor:IRRadance:MAXimum?	Returns the maximum KFactor Irradiance Value that can be set	N
SASimulator:CURVe:SNL:Kfactor:IRRadance:MINimum?	Returns the minimum KFactor Irradiance Value that can be set	N
SASimulator:CURVe:SNL:Kfactor:IRRadance?	Returns the KFactor Irradiance Value of the Selected SNL Curve	N
SASimulator:CURVe:SNL:Kfactor:VOLtage <Nrf>	Sets the KFactor Voltage Value to Selected SNL Curve	N
SASimulator:CURVe:SNL:Kfactor:VOLtage:MAXimum?	Returns the maximum KFactor Voltage Value that can be set in	N
SASimulator:CURVe:SNL:Kfactor:VOLtage:MINimum?	Returns the minimum KFactor Voltage Value that can be set	N
SASimulator:CURVe:SNL:Kfactor:VOLtage?	Returns the KFactor Voltage Value of the Selected SNL Curve	N
SASimulator:CURVe:SNL:MPPparams:Imp <Nrf>	Sets the Current at Maximum power point to Selected SNL Curve	N
SASimulator:CURVe:SNL:MPPparams:Imp:MAXimum?	Returns the Maximum Current Value at maximum power point in the SNL Curve type that can be set in amps	N
SASimulator:CURVe:SNL:MPPparams:Imp:MINimum?	Returns the Minimum Current Value at maximum power point in the SNL Curve type that can be set in amps	N
SASimulator:CURVe:SNL:MPPparams:Imp?	Returns the Current at Maximum power point of Selected SNL Curve in amps	N
SASimulator:CURVe:SNL:MPPparams:Vmp <Nrf>	Sets the Voltage at Maximum power point to Selected SNL Curve in volts	N
SASimulator:CURVe:SNL:MPPparams:Vmp:MAXimum?	Returns the Maximum Voltage Value at maximum power point in the SNL Curve type that can be set in volts	N
SASimulator:CURVe:SNL:MPPparams:Vmp:MINimum?	Returns the Minimum Voltage Value at maximum power point in the SNL Curve type that can be set in volts	N
SASimulator:CURVe:SNL:MPPparams:Vmp?	Returns the Voltage at Maximum power point of Selected SNL Curve in volts	N

COMMAND	DESCRIPTION	SCPI
SASimulator:CURVe:SNL:VIp arams:Isc <NRf>	Sets the Short Circuit Current to Selected SNL Curve in amps	N
SASimulator:CURVe:SNL:VIp arams:Isc:MAXimum?	Returns the Maximum Short Circuit Current in the SNL Curve type that can be set in amps	N
SASimulator:CURVe:SNL:VIp arams:Isc:MINimum?	Returns the Minimum Short Circuit current in the SNL Curve type that can be set in amps	N
SASimulator:CURVe:SNL:VIp arams:Isc?	Returns the Short Circuit Current of Selected SNL Curve in amps	N
SASimulator:CURVe:SNL:VIp arams:Voc <NRf>	Sets the Open Circuit Voltage Selected SNL Curve in volts	N
SASimulator:CURVe:SNL:Vip arams:Voc:MAXimum?	Returns the Maximum Open Circuit Voltage in the SNL Curve type that can be set in volts	N
SASimulator:CURVe:SNL:Vip arams:Voc:MINimum?	Returns the Minimum Open Circuit voltage in the SNL Curve type that can be set in volts	N
SASimulator:CURVe:SNL:Vip arams:Voc?	Returns the Open Circuit Voltage of Selected SNL Curve in volts	N
SASimulator:CURVe:TYPE <SNL/0 EN50530/1 Userdefi ned VI points/2>	Sets the Operating Curve type of the PV Simulator	N
SASimulator:CURVe:TYPE?	Returns the Selected curve type of PV Simulator 0 – SNL 1 – EN50530 3 – User Defined Curve	N
SASimulator:MPP?	Returns the MPPT Tracking efficiency of the UUT	N
SASimulator:OPERATING:MOD E <Standard/0 Array/1>	Sets the Operating mode of the Curve type	N
SASimulator:OPERATING:MOD E?	Returns the Selected operating mode of the curve type 0 – Standard 1 – Array	N
SASimulator:OPERATING:TYP E <Steadystate/0 profiles/1 >	Sets the Operating type of the Selected Operating mode that PV Simulator operates	N
SASimulator:CURVe:TYPE?	Returns the operating type of the Selected Operating mode	N
SASimulator:PMP?	Returns the Calculated Maximum power at Maximum power point of Selected IV Curve in kW	N
SASimulator:SOURce:EN5053 0:POWer <NRf>	Sets the Rated Power of Selected EN50530 Curve in kW	N
SASimulator:SOURce:EN5053 0:POWer:MAXimum?	Returns the Maximum Rated power Value that can be set in the EN50530 Curve in kw	N
SASimulator:SOURce:EN5053 0:POWer:MINimum?	Returns the Minimum Rated Power Value that can be sets in the EN50530 Curve in kW	N

COMMAND	DESCRIPTION	SCPI
SASimulator:SOURce:EN50530:POWer?	Returns the Rated Power Value of the selected EN50530 Curve in kW	N
SASimulator:SOURce:EN50530:SIMtype:TECHnology <CSI/0 ThinFlim/1>	Sets the Technology of the Selected EN50530 Curve	N
SASimulator:SOURce:EN50530:SIMtype:TECHnology?	Returns the Technology type of the EN50530 curve 0 – CSI Type, 1 – Thin Film type	N
SASimulator<n>:SOURce:EN50530:SIMtype:TESTtype <Static/0 Dynamic/1>	Sets the Test Type of the EN50530 Curve	N
SASimulator<n>:SOURce:EN50530:SIMtype:TESTtype?	Returns the Test type of the EN50530 Curve 0 – Static, 1 – Dynamic	N
SASimulator:SOURce:EN50530:VOLTage<NRf>	Sets the Rated Voltage Value of the EN50530 Curve in volts	N
SASimulator:SOURce:EN50530:VOLTage:MAXimum?	Returns the Maximum Rated Voltage Value that can be set in the EN50530 Curve in volts	N
SASimulator:SOURce:EN50530:VOLTage:MINimum?	Returns the Minimum Rated Voltage Value that can be sets in the EN50530 Curve in volts	N
SASimulator:SOURce:EN50530:VOLTage?	Returns the Rated Voltage value of the selected EN50530 Curve in volts	N
SASimulator:SOURce:IRRadiance <NRf>	Sets the Irradiance of the Selected IV Curve	N
SASimulator:SOURce:IRRadiance:MAXimum?	Returns the Maximum Irradiance Value that can be set to the Curve	N
SASimulator:SOURce:IRRadiance:MINimum?	Returns the Minimum Irradiance Value that can be set to the curve	N
SASimulator:SOURce:IRRadiance?	Returns the Irradiance value of the selected Curve	N
SASimulator:SOURce:TEMPerature <NRf>	Sets the Temperature of the Selected IV Curve	N
SASimulator:SOURce:TEMPerature:MAXimum?	Returns the Maximum Temperature Value that can be set to the Curve	N
SASimulator:SOURce:TEMPerature:MINimum?	Returns the Minimum Temperature Value that can be set to the curve	N
SASimulator:SOURce:TEMPerature?	Returns the Temperature value of the selected Curve	N
SASimulator:STATUS?	Returns the status of the PV Simulator 0 – IDLE 1 – INITIALIZING 2 – INITIALIZED 3 – RUNNING 5 – ABORTED 6 – PAUSED 7 – TRIPPED	N
SASimulator:LOAD <0 1>	Loads the Selected IV Curve to PV Simulator	N

COMMAND	DESCRIPTION	SCPI
	0 – Unloads the IV Curve, 1 – Loads the Selected IV Curve	
SASimulator:LOAD?	Returns the load status of the selected IV Curve to the PV Simulator 0 – Not Loaded ,1 – Loaded	N

Table 9-8: PVSIM SCPI Command reference

9.6 BATSIM SCPI COMMAND SYSTEM

This section first presents a tree summary of the Battery Simulator commands and then provides a tabular description

9.6.1 BATSIM SCPI COMMAND SUMMARY

```

BATTery
  :SIMulation
    :CAPacity
    :CAPacity
      :MAXimum?
      :MINimum?
    :CAPacity?
    :CHARge
      :CURRent
      :CURRent
        :MAXimum?
        :MINimum?
      :CURRent?
    :CURRent
      :MINimum?
      :MINimum?
    :CUTOFF
      :CAPacity
        :HIGH
        :HIGH?
        :LOW
        :LOW?
      :CAPacity
        :HIGH
          :MAXimum?
          :MINimum?
        :LOW
          :MAXimum?
          :MINimum?
    :SOC
      :HIGH
        :MAXimum?
  
```

```

BATTery
  :SIMulation
    :CUTOFF
      :SOC
        :HIGH
          :MINimum?
        :HIGH?
      :SOC
        :LOW
          :MAXimum?
          :MINimum?
        :LOW?
    :DISCharge
      :CURRent
        :MAXimum?
        :MINimum?
    :DISCharge
      :CURRent?
    :EMPTYVOLT
    :EMPTYVOLT?
    :FULLVOLT
    :FULLVOLT?
    :INITial
      :SOC
      :SOC?
    :PARALLEL
      :MAXimum?
      :MINimum?
    :PARALLEL?
    :PROFile
      :ADD
      :SAVE
      :SElect
      :SElect?
      :TYPE
      :TYPE?
    :PROFile
      :CATALOG?
      :DELeTe
        :ALL
      :LOAD
      :LOAD?
      :TABLE
        :DEFine
          :OCV
            :POINTS
            :POINTS?
          :RESistance
            :POINTS
            :POINTS?

```

```

BATTery
  :SIMulation
    :PROFile
      :TABLE
        :DEFine
          :SOC
            :POINTS
            :POINTS?
    :SERies
      :RESistance
      :RESistance?
    :SERies
      :MAXimum?
      :MINimum?
    :SERies
      :RESistance
        :MAXimum?
        :MINimum?
    :SERies?
    :SOC
      :MAXimum?
      :MINimum?
    :STATe
    :STATe?
    :STATUS?
    :TIME
      :ELAPSED?
    :TOTAL
    :PACK
      :CAPacity?
      :EMPTYVOLT?
      :ESR?
      :FULLVOLT?
    :VOLTage
      :MAXimum?
      :MINimum?

```

9.6.2 BATTSIM SCPI COMMAND REFERENCE

The letter “C” in the “SCPI” column means that the command syntax is SCPI compliant; an “N” in the “SCPI” column means that the command syntax is not part of the SCPI definition.

COMMAND	DESCRIPTION	SCPI
BATTery:SIMulation:CAPacity <NRf>	Sets the Capacity of the Battery in Ah to the Selected Battery Configuration profile	N
BATTery:SIMulation:CAPacity:MAXimum?	Returns the Maximum value of the capacity can be set for the Battery simulation in Ah	N
BATTery:SIMulation:CAPacity:MINimum?	Returns the Minimum value of the capacity can be set for the Battery simulation in Ah	N

COMMAND	DESCRIPTION	SCPI
BATTery:SIMulation:CAPacity?	Returns the Capacity value of the Selected Battery configuration profile in Ah	N
BATTery:SIM:CHARGE:CURRent <NRf>	Sets the charging current of the Selected battery configuring in Amps	N
BATTery:SIMulation:CHARge:CURRent:MAXimum?	Returns the maximum charging current of the battery configuration in Amps	N
BATTery:SIMulation:CHARge:CURRent:MINimum?	Returns the minimum charging current of the battery configuration in Amps	N
BATTery:SIMulation:CHARGE:CURRent?	Returns the charging current of the battery configuration in Amps	N
BATTery:SIMulation:CURRent:Maximum?	Returns the Maximum current that can be set to the battery simulator in Amps	N
BATTery:SIMulation:CURRent:MINimum?	Returns the Minimum Current that can be set to the battery simulator in Amps	N
BATTery:SIMulation:CUTOFF:CAPacity:HIGH <NRf>	Sets Capacity High cut off condition value at which battery turns off the output in Ah	N
BATTery:SIMulation:CUTOFF:CAPacity:HIGH:MAXimum?	Returns the Maximum capacity cutoff condition value of battery simulator in Ah	N
BATTery:SIMulation:CUTOFF:CAPacity:HIGH:MINimum?	Returns the minimum capacity high cut off condition value of battery simulator in Ah	N
BATTery:SIMulation:CUTOFF:CAPacity:HIGH?	Returns the capacity High Cut off condition value of battery simulator in Ah	N
BATTery:SIMulation:CUTOFF:CAPacity:LOW <NR1>	Sets the Capacity Low cut off condition value of battery simulator in Ah	N
BATTery:SIMulation:CUTOFF:CAPacity:LOW:MAXimum?	Returns the maximum capacity low of the battery simulator in Ah	N
BATTery:SIMulation:CUTOFF:CAPacity:LOW:MINimum?	Returns the minimum capacity low cut off that can be set to the battery simulator in Ah	N
BATTery:SIMulation:CUTOFF:CAPacity:LOW?	Returns the capacity Low Cut off value of the battery simulator in Ah	N
BATTery:SIMulation:CUTOFF:SOC:HIGH <NRf>	Sets the SOC High Cut Off value to the battery simulator in Ah	N
BATTery:SIMulation:CUTOFF:SOC:HIGH:MAXimum?	Returns the maximum SOC High Cut off Value that can be set to Battery simulator	N
BATTery:SIMulation:CUTOFF:SOC:HIGH:MINimum?	Returns the minimum SOC High Cut off Value that can be set to Battery simulator	N
BATTery:SIMulation:CUTOFF:SOC:HIGH?	Returns the SOC High Cut off Value of the Battery simulator	N
BATTery:SIMulation:CUTOFF:SOC:LOW <NRf>	Sets the SOC Low Cut Off value to the battery simulator	N
BATTery:SIMulation:CUTOFF:SOC:LOW:MAXimum?	Returns the maximum SOC Low Cut off Value that can be set to Battery simulator	N
BATTery:SIMulation:CUTOFF:SOC:LOW:MINimum?	Returns the minimum SOC Low Cut off Value that can be set to Battery simulator	N

COMMAND	DESCRIPTION	SCPI
BATTery:SIMulation:CUTOFF:SOC:LOW?	Returns the SOC Low Cut off Value of the Battery simulator	N
BATTery:SIMulation:DISCHARGE:CURRENT <NRf>	Sets the Discharge current to the Selected battery profile in Amps	N
BATTery:SIMulation:DISCHARGE:CURRENT:MAXimum?	Returns the maximum Discharge current that can be set to battery simulator in Amps	N
BATTery:SIMulation:DISCHARGE:CURRENT:MINimum?	Returns the minimum Discharge Current that can be set to the battery simulator in Amps	N
BATTery:SIMulation:DISCHARGE:CURRENT?	Returns the Discharge Current of the Selected Battery configuration in Amps	N
BATTery:SIMulation:EMPTYVOLT <NRf>	Sets the Empty Volt value to the selected battery configuration in Volts	N
BATTery:SIMulation:EMPTYVOLT?	Returns the Empty Volt Value of the selected battery configuration in Volts	N
BATTery:SIMulation:FULLVOLT <NRf>	Sets the Full Volt value to the selected battery configuration in Volts	N
BATTery:SIMulation:FULLVOLT?	Returns the Full Volt Value of the selected battery configuration in Volts	N
BATTery:SIMulation:INITial:SOC <NRf>	Sets the Initial SOC value to the selected battery configuration	N
BATTery:SIMulation:INITial:SOC?	Returns the Initial SOC Value of the selected battery configuration	N
BATTery:SIMulation:PARALLEL <NR1>	Sets the Number of batteries connected in parallel in battery pack of the selected battery configuration	N
BATTery:SIMulation:PARALLEL:MAXimum?	Returns the maximum Number of batteries connected in parallel in battery pack to the selected battery configuration	N
BATTery:SIMulation:PARALLEL:MINimum?	Returns the minimum Number of batteries connected in parallel in battery pack of the selected battery configuration	N
BATTery:SIMulation:PARALLEL?	Returns the Number of batteries connected in parallel in battery pack of the selected battery configuration	N
BATTery:SIMulation:PROF:ADD <string>	Creates the profile with file name in selected battery configuration	N
BATTery:SIMulation:PROF:SAVE	Saves the Selected battery profiles to device	N
BATTery:SIMulation:PROF:SEL <string>	Sets the battery profile file name to be selected	N
BATTery:SIMulation:PROF:SEL?	Returns the battery profile selected in the battery type configuration	N
BATTery:SIMulation:PROF:TYPE <Battery Model/0 Table Model/1>	Sets the Battery configuration type to the battery simulator	N

COMMAND	DESCRIPTION	SCPI
BATTery:SIMulation:PROF:TYPE?	Returns the Selected battery configuration of battery simulator 0 – Battery Model 1 – Table Model	N
BATTery:SIMulation:PROFILE:CATALOG?	Returns all the file names of battery profiles present in the selected battery configuration	N
BATTery:SIMulation:PROFILE:DEL <string>	Deletes the provided battery profile file in the selected battery configuration	N
BATTery:SIMulation:PROFILE:DEL:ALL	Deletes all the profiles present in the selected battery configuration	N
BATTery:SIMulation:PROFILE:LOAD <UNLOADED/0 LOADED/1>	Loads the selected battery profile to the battery simulator	N
BATTery:SIMulation:PROFILE:LOAD?	Returns the Load status of the battery simulator 0 – UNLOADED 1 – LOADED	N
BATTery:SIMulation:PROFILE:TABLE:DEF:OCV:POINTS <Nrf>, <Nrf>, . . . , <Nrf>	Sets the Open circuit voltage points of the battery to the selected battery profile in Volts. Number of points provided to be same as provided table size	N
BATTery:SIMulation:PROFILE:TABLE:DEF:OCV:POINTS?	Returns the opens circuit voltage points of the selected battery profile in Volts	N
BATTery:SIMulation:PROFILE:TABLE:DEF:POINTS:SIZE <NR1>	Sets the table size to the selected battery profile in the table mode	N
BATTery:SIMulation:PROFILE:TABLE:DEF:RESistance:POINTS <Nrf>, <Nrf>, . . . , <Nrf>	Sets the Series resistance points in ohms to selected battery profile in the table mode configuration	N
BATTery:SIMulation:PROFILE:TABLE:DEF:RES:POINTS?	Return the series resistance points in ohms of the selected battery profile in the table mode configuration	N
BATTery:SIMulation:PROFILE:TABLE:DEF:SOC:POINTS <Nrf>, <Nrf>, . . . , <Nrf>	Sets the State of Charge points of the battery to selected battery profile. 1 st point of the table must be “0”. And last point in the table must be “100”.	N
BATTery:SIMulation:PROFILE:TABLE:DEF:SOC:POINTS?	Returns the State of Charge points of the selected battery profile	N
BATTery:SIMulation:SER:RES <Nrf>	Sets the Series resistance of the battery to the selected battery profile in the Battery model type in ohms	N
BATTery:SIMulation:SERies:RESistance:MAXimum?	Returns the Maximum Series resistance of the battery that can be set in the Battery model type in ohms	N
BATTery:SIMulation:SERies:RESistance:MINimum?	Returns the Minimum Series resistance of the battery that can be set in the Battery model type in ohms	N

COMMAND	DESCRIPTION	SCPI
BATTery:SIMulation:SER:RES?	Returns the Series resistance of the battery to the selected battery profile in the Battery model type in ohms	N
BATTery:SIMulation:SERIES <NR1>	Sets the number of batteries connected in series in the battery pack to the selected Battery profile	N
BATTery:SIMulation:SERIES:MAXimum?	Returns the Maximum number of batteries connected in series in the battery pack that can be set to battery simulator	N
BATTery:SIMulation:SERIES:MINimum?	Returns the Minimum number of batteries connected in series in the battery pack that can be set to battery simulator	N
BATTery:SIMulation:SERIES?	Returns the number of batteries connected in series in the battery pack to the selected Battery profile	N
BATTery:SIMulation:SOC:MAXimum?	Returns maximum state of charge of the battery that can be set	N
BATTery:SIMulation:SOC:MINimum?	Returns minimum state of charge of the battery that can be set	N
BATTery:SIMulation:STATE <Abort/0 RUN/1 PAUSE/2 RESUME/3 TRIPPED/4 IDLE/5 INIT/6>	Sets the operation state of the battery simulator	N
BATTery:SIMulation:STATE?	Returns the operation state of the battery simulator 0 – Abort (Simulation Aborted) 1 – RUN (Simulation Running) 2 – PAUSE (Simulation paused) 3 – RESUME (Simulation resumed) 4 – TRIPPED 5 – IDLE 6 – INIT (Simulation Initialized)	N
BATTery:SIMulation:STATUS?	Returns the Status of the Battery simulator 0 – IDLE 1 – INITIALIZING 2 – INITIALIZED 3 – RUNNING 5 – ABORTED 6 – PAUSED 7 – TRIPPED	N
BATTery:SIMulation:TIME:ELAPSED?	Returns the time elapsed in the RUN state of battery simulator in seconds	N
BATTery:SIMulation:TOTAL:CAPACITY?	Returns the Total Calculated capacity of the battery pack in Ah	N
BATTery:SIMulation:TOTAL:EMPTYVOLT?	Returns the Total Empty Voltage of the battery pack in volts	N

COMMAND	DESCRIPTION	SCPI
BATTery:SIMulation:TOTAL:FULLVOL T?	Returns the Total Full Voltage of battery pack in volts	N
BATTery:SIMulation:TOTAL:ESR?	Returns the Total series resistance of the battery pack in Ohms	N
BATTery:SIMulation:VOLTage:MAXim um?	Returns the maximum voltage value that can be set in the battery simulator in volts	N
BATTery:SIMulation:VOLTage:MINim um?	Returns the minimum voltage value that can be set in the battery simulator in volts	N

Table 9-9: BATSIM SCPI Command reference

9.7 BATTEST SCPI COMMAND SYSTEM

This section first presents a tree summary of the Battery Test commands and then provides a tabular description.

9.7.1 BATTEST SCPI COMMAND SUMMARY

```

BATTery
  :TEST
    :CHARge
      :CURRent
      :CURRent?
      :STOP
      :CAPacity
      :CAPacity?
      :VOLTage
      :VOLTage?
      :TYPE
      :TYPE?
      :VOLTage
      :LIMit
      :LIMit?
    :CONFigure
      :ADD
      :CAPacity
      :LIMit
      :LIMit?
      :CATalogue?
      :CAPacity
      :MAXimum?
      :MINimum?

```

```
BATTeRy
:TEST
:CONFiGure
:  CHARge
:    CURRent
:      LIMit
:      LIMit?
:DELeTe
:DISCHARge
:  CURRent
:    LIMit
:    LIMit?
:LOAD
:LOAD?
:SAVE
:SELeCt
:SELeCt?
:VOLTagE
:  MAXimum
:  MAXimum?
:  MINimum
:  MINimum?
:DISCHARge
:  CURRent
:  CURRent?
:  STOP
:    CAPacity
:    CAPacity?
:    VOLTagE
:    VOLTagE?
:VOLTagE
:  LIMit
:  LIMit?
:INITIAL
:  CAPacity
:  CAPacity?
:MODE
:MODE?
:OPERATION
:  TYPE
:  TYPE?
:STATe
:STATe?
:STATUS?
:STOP
:  TIME
:    MAXimum?
:    MINimum?
:  TIME?
```

```

BATTery
  :TEST
    :TERMination
      :CURRent
      :CURRent?
    :TIME
      :ELAPSED?

```

9.7.2 BATEST SCPI COMMAND REFERENCE

The letter “C” in the “SCPI” column means that the command syntax is SCPI compliant; an “N” in the “SCPI” column means that the command syntax is not part of the SCPI definition.

COMMAND	DESCRIPTION	SCPI
BATTery:TEST:CHARGE:CURRent <NRf>	Sets the Charging Current value to battery tester in Amps	N
BATTery:TEST:CHARGE:CURRENT?	Returns the Charging Current value of battery tester in amps	N
BATTery:TEST:CHARGE:TYPE <0 1>	Sets the Charging type value to the Selected Battery tester profile	N
BATTery:TEST:CHARGE:TYPE?	Returns the Charging type in the selected battery tester profile 0 – CC 1 – CC/CV	N
BATTery:TEST:CHARGE:STOP:CAPacity <NRf>	Sets the Stop Capacity Value to the battery tester at which System turns the Output OFF in Ah	N
BATTery:TEST:CHARGE:STOP:CAPacity?	Returns the Stop Capacity Value of the battery tester in Ah	N
BATTery:TEST:CHARGE:STOP:VOLTage <NRf>	Sets the Stop Voltage Value in volts to the battery tester at which System turns the Output OFF	N
BATTery:TEST:CHARGE:STOP:VOLTage?	Returns the Stop Voltage Value of the battery tester in volts	N
BATTery:TEST:CHARGE:VOLTage:LIMIT <NRf>	Sets the Charging Voltage Limit value to the Selected Battery tester profile in volts	N
BATTery:TEST:CHARGE:VOLTage:LIMIT?	Returns the Charging Voltage Limit value of the selected battery tester profile in volts	N
BATTery:TEST:CONFIG:ADD <String>	Creates the Battery tester profile with provided file name	N
BATTery:TEST:CONFIG:CAPacity:LIMIT <NRf>	Sets the Capacity Limit Value that the user can set to Selected battery tester profile in Ah	N
BATTery:TEST:CONFIG:CAPacity:LIMIT?	Returns the Capacity Limit Value set in the selected battery tester profile in Ah	N

COMMAND	DESCRIPTION	SCPI
BATTery:TEST:CONFIG:CAT?	Returns all profile file names present in the selected Battery tester operating type	N
BATTery:TEST:CONFIG:CAPacity:MAXimum?	Returns the maximum capacity that can be set to the battery tester in Ah	N
BATTery:TEST:CONFIG:CAPacity:MINimum?	Returns the minimum capacity that can be set to the battery tester in Ah	N
BATTery:TEST:CONFIG:CHARGE:CURRENT:LIMit <NRf>	Sets the charging current limit that can be set to selected battery tester profile in amps	N
BATTery:TEST:CONFIG:CHARGE:CURRENT:LIMit?	Returns the charging current limit of the selected battery tester profile in amps	N
BATTery:TEST:CONFIG:DElete <String>	Deletes the profile with the provided file name from the Selected battery tester operation type	N
BATTery:TEST:CONFIG:DISCHARGE:CURRENT:LIMit <NRf>	Sets the Discharging current limit to the selected battery tester profile in amps	N
BATTery:TEST:CONFIG:DISCHARGE:CURRENT:LIMit?	Returns the Discharging Current limit value from the selected battery tester profile in amps	N
BATTery:TEST:CONFIG:LOAD <UNLOAD/0 LOAD/1>	Loads the selected battery profile	N
BATTery:TEST:CONFIG:LOAD?	Returns the load status of the battery tester 0 – UNLOADED 1 – LOADED	N
BATTery:TEST:CONFIG:SAVE	Saves the Selected Battery tester profile	N
BATTery:TEST:CONFIG:SElect <string>	Selects the battery tester profile with the provided file name	N
BATTery:TEST:CONFIG:SElect?	Returns the Selected battery tester profile	N
BATTery:TEST:CONFIG:VOLTage:MAXimum <NRf>	Sets the Maximum Voltage that can be set by the user in volts	N
BATTery:TEST:CONFIG:VOLTage:MAXimum?	Returns the Maximum Voltage Value that can be set by the user in the battery tester in volts	N
BATTery:TEST:CONFIG:VOLTage:MINimum <NRf>	Sets the Minimum Voltage value that can be set by the user in Battery tester in volts	N
BATTery:TEST:CONFIG:VOLTage:MINimum?	Returns the Minimum Voltage value that can be set by the user in Battery tester in volts	N
BATTery:TEST:DISCHARGE:CURRENT <NRf>	Sets the Discharging current Value to battery tester in amps	N
BATTery:TEST:DISCHARGE:CURRENT?	Returns the Discharging Current Value to battery tester in amps	N

COMMAND	DESCRIPTION	SCPI
BATTer:TEST:DISCHARGE:STOP:CAPacity <Nrf>	Sets the Stop Capacity value in Ah at which the system stops the discharging by turning the system off	N
BATTery:TEST:DISCHARGE:STOP:CAPacity?	Returns the stop Capacity value of the discharging operation type in Ah	N
BATTery:TEST:DISCHARGE:STOP:VOLTage <Nrf>	Sets the Stop Voltage value in volts, at which the system stops the discharging by turning the system off	N
BATTery:TEST:DISCHARGE:STOP:VOLTage?	Returns the Stop Voltage Value of the discharging operation type in volts	N
BATTery:TEST:DISCHARGE:VOLTage:LIMIT <Nrf>	Sets the Discharging voltage limit value to the selected battery tester profile.	N
BATTery:TEST:DISCHARGE:VOLTage:LIMIT?	Returns the Discharging voltage limit value from the selected battery tester profile in volts	N
BATTery:TEST:INITIAL:CAPACITY <Nrf>	Sets the Initial Capacity of the battery to the selected battery tester profile in Ah	N
BATTery:TEST:INITIAL:CAPACITY?	Returns the Initial Capacity of the battery to the selected battery tester profile in Ah	N
BATTery:TEST:MODE <0 1>	Sets the Operation Mode of the battery tester	N
BATTery:TEST:MODE?	Returns the operation Mode of the battery tester 0 – Steady State 1 – Sequence	N
BATTery:TEST:OPERATION:TYPE <0 1>	Sets the Operation type of the battery tester	N
BATTery:TEST:OPERATION:TYPE?	Returns the operation type of the battery tester 0 – Charging 1 – Discharging	N
BATTery:TEST:STATE <Abort/0 RUN/1 PAUSE/2 RESUME/3 TRIPPED/4 IDLE/5>	Sets the State of the battery tester	N
BATTery:TEST:STATE?	Returns the state of the Battery tester 0 – Abort 1 – RUN 2 – PAUSE 3 – RESUME 4 – IDLE 5 – INIT	N

COMMAND	DESCRIPTION	SCPI
BATtery:TEST:STATUS?	Returns the status of the battery tester 0 – IDLE 1 – INITIALIZING 2 – INITIALIZED 3 – RUNNING 5 - ABORTED 6 – PAUSED 7 – TRIPPED	N
BATtery:TEST:STOP:TIME <NR1>	Sets the stop time in seconds, the system will turn output off after the provided period of seconds	N
BATtery:TEST:STOP:TIME:MAXimum?	Returns the maximum stop time in seconds that can be set by the user	N
BATtery:TEST:STOP:TIME:MINimum?	Returns the minimum stop time in seconds that can be set by the user	N
BATtery:TEST:STOP:TIME?	Returns the stop time in seconds	N
BATtery:TEST:TERMination:CURRent <NRf>	Sets the termination current in amps to the battery tester profile. The Output of the system will turn off when the charging current reaches the termination current	N
BATtery:TEST:TERMination:CURRent?	Returns the termination current from the selected battery tester profile	N
BATtery:TEST:TIME:ELAPSED?	Returns the elapsed run time in seconds	N

Table 9-10: BATTEST SCPI Command reference

9.8 CALIBRATION INIT AND PONS SCPI COMMAND SUBSYSTEM

This section first presents a tree summary of the Calibration commands and then provides a tabular description.

9.8.1 CALIBRATION INIT AND PONS SCPI COMMAND SUMMARY

```

CALibrate
  :INITial
  :AC
    :INPUT
      :CONFigure
      :CONFigure?
  :CHASSIS
    :ADDRESS
    :ADDRESS?
  :CURRent <fval>

```



```
CALibrate
  :INITial
    :CURRent
      :MAXimum?
      :MINimum?
      :MONitor
      :MONitor
        :FSC <NRf>
        :FSC?
      :NEGative
        :LIMit
        :LIMit?
        :LIMit
          :MAXimum?
          :MINimum?
      :POSitive
        :LIMit
        :LIMit?
        :LIMit
          :MAXimum?
          :MINimum?
      :PROG
        :FSC <NRf>
        :FSC?
        :FSCR <NRf>
        :FSCR?
        :SOURce
        :SOURce?
      :PROGrama?
      :SLEW
        :TYPE
        :TYPE?
      :SLEW?
      :SOFT
        :LIMit
          :HIGH
          :HIGH?
          :LOW
          :LOW?
    :CURRent
      :PROTection
        :NEGative <fval>
        :NEGative
          :MAXimum?
          :MINimum?
        :NEGative?
        :POSitive <fval>
```

CALibrate

```

:INITial
  :CURRent
    :PROTection
      :POSitive
        :MAXimum?
        :MINimum?
      :POSitive?
  :CURRent?
  :MEAS
    :CURRent
      :AVERAGE
      :AVERAGE?
    :VOLTage
      :AVERAGE
      :AVERAGE?
  :OPERating
    :MODE <SOUR | ELOAD | DTEST | BATSIM | PVSIM | BATTEST>
    :MODE?
  :OUTPut
    :ISOLation?
    :PROG
      :TYPE <ival>
      :TYPE?
    :PROTection
      :DELAY
      :DELAY?
      :FOLD <ival>
      :FOLD?
    :SENSE
    :SENSE?
  :PONS
    :DEFAULT
  :POWer <fval>
  :POWER
    :MAXimum?
    :MINimum?
  :POWer
    :NEGative
      :LIMit
      :LIMit?
      :MAXimum?
      :MINimum?
    :POSitive
      :LIMit
      :LIMit?
      :LIMit
      :MAXimum?
      :MINimum?

```

```

CALibrate
  :INITial
    :POWer
      :PROTection
        :NEGative <fval>
        :NEGative?
        :NEGative
          :MAXimum?
          :MINimum?
        :POSitive <fval>
        :POSitive?
        :POSitive
          :MAXimum?
          :MINimum?
      :SLEW
        :TYPE
        :TYPE?
      :SLEW?
      :SOFT
        :LIMit
          :HIGH
          :HIGH?
          :LOW
          :LOW?
    :POWer?
    :REMote
      :INHIBIT
        :INPUT
          :STATe
          :STATe?
          :TYPE
          :TYPE?
        :MODE
        :MODE?
    :SERIES
      :RESistance
        :MAXimum?
        :MINimum?
      :RESistance?
    :SINK
      :RESistance
      :RESistance
        :MAXimum?
        :MINimum?
      :RESistance?
    :VOLTage <fval>
    :VOLTage?

```

```

CALibrate
  :INITial
    :VOLtage
      :HIGH
        :LIMit
        :LIMit?
      :LOW
        :LIMit
        :LIMit?
      :MAXimum?
      :MINimum?
      :MONitor
        :FSC <NRf>
        :FSC?
      :PROG <NR1>
      :PROG
        :FSC <NRf>
        :FSC?
        :FSCR <NRf>
        :FSCR?
        :SOUR
        :SOUR?
      :PROgram?
      :PROtection <fval>
      :PROtection?
      :PROtection
        :FSC
        :FSC?
        :PROgram
        :PROgram?
      :SLEW
        :TYPE
        :TYPE?
      :SLEW?
      :SOFT
        :HIGH
          :LIMit
          :LIMit?
        :LOW
          :LIMit
          :LIMit?

```

9.8.2 CALIBRATION INIT AND PONS SCPI COMMAND

REFERENCE

The letter “C” in the “SCPI” column means that the command syntax is SCPI compliant; an “N” in the “SCPI” column means that the command syntax is not part of the SCPI definition.

COMMAND	DESCRIPTION	SCPI
CALibrate:INITial:AC:INPUT:CO NFigure <0 1>	Changes the power-on AC input settings. Valid arguments are: 0 – High Line (380 – 480 V Nominal) 1 – Low Line (200 – 240 V Nominal).	N
CALibrate:INITial:AC:INPUT:CO NFigure?	Returns the AC input settings.	N
CALibrate:INITial:CHASSIS:ADD RESS <NR1>	Sets the power-on default chassis address.	N
CALibrate:INITial:CHASSIS:ADD RESS?	Returns the power-on default chassis address.	N
CALibrate:INITial:CURRent <NRf>	Sets the power-on value of current.	N
CALibrate:INITial:CURRent?	Returns the value of power-on current.	N
CALibrate:INITial:CURRent:MAX imum?	Returns the power-on value of maximum current that can be set.	N
CALibrate:INITial:CURRent:MIN imum?	Returns the power-on value of minimum current that can be set.	N
CALibrate:INITial:CURRent:MON itor <NRf>	Initializes the current monitor (IMON) signal calibration.	N
CALibrate:INITial:CURRent:MON itor:FSC <NRf>	Sets the power-on default voltage on IMON signal for full scale output current.	N
CALibrate:INITial:CURRent:MON itor:FSC?	Returns the power-on default full scale voltage value on IMON signal.	N
CALibrate:INITial:CURRent:NEG ative:LIMit <NRf>	Sets the power-on default value for negative current limit.	N
CALibrate:INITial:CURRent:NEG ative:LIMit?	Returns the power-on default value for negative current limit.	N
CALibrate:INITial:CURRent:NEG ative:LIMit:MAXimum?	Returns the power-on default value for maximum level of negative current limit.	N
CALibrate:INITial:CURRent:NEG ative:LIMit:MINimum?	Returns the power-on default value for minimum level of negative current limit.	N
CALibrate:INITial:CURRent:POS itive:LIMit <NRf>	Sets the power-on default value for positive current limit.	N
CALibrate:INITial:CURRent:POS itive:LIMit?	Returns the power-on default value for positive current limit.	N
CALibrate:INITial:CURRent:POS itive:LIMit:MAXimum?	Returns the power-on default value for maximum level of positive current limit.	N
CALibrate:INITial:CURRent:POS itive:LIMit:MINimum?	Returns the power-on default value for minimum level of positive current limit.	N
CALibrate:INITial:CURRent:PRO Gram:FSC <NRf>	Sets the power-on default full-scale voltage value for rated current from external analog programming.	N
CALibrate:INITial:CURRent:PRO Gram:FSC?	Returns the power-on default full scale voltage value for rated current from external analog programming.	N

COMMAND	DESCRIPTION	SCPI
CALibrate:INITial:CURRent:PROGram:FSCR <NRf>	Sets the power-on default full-scale resistance value for rated current from external analog programming.	N
CALibrate:INITial:CURRent:PROGram:FSCR?	Returns the power-on default full scale resistance value for rated current from external analog programming.	N
CALibrate:INITial:CURRent:SLEW <NRf>, <NRf>	Sets the power-on default slew rate for current.	N
CALibrate:INITial:CURRent:SLEW:TYPE <0 1>	Changes the power-on default slew type for current. Valid arguments are: 0 – Slew in A/ms 1 – Slew in seconds.	N
CALibrate:INITial:CURRent:SLEW:TYPE?	Returns the power-on default slew type for current.	N
CALibrate:INITial:CURRent:SLEW?	Returns the power-on default slew rate for current.	N
CALibrate:INITial:CURRent:SOFT:LIMit:HIGH <NRf>	Sets the power-on default value for maximum soft-limit of current.	N
CALibrate:INITial:CURRent:SOFT:LIMit:HIGH?	Returns the power-on default value for maximum soft-limit of current.	N
CALibrate:INITial:CURRent:SOFT:LIMit:LOW <NRf>	Sets the power-on default value for minimum soft-limit of current.	N
CALibrate:INITial:CURRent:SOFT:LIMit:LOW?	Returns the power-on default value for minimum soft-limit of current.	N
CALibrate:INITial:CURRent <NRf>	Sets the power-on default value of current.	N
CALibrate:INITial:CURRENT:PROTECTION:NEGative <NRf>	Sets the power-on default overcurrent protection limit for negative current.	N
CALibrate:INITial:CURRENT:PROTECTION:NEGative?	Returns the power-on default overcurrent protection limit for negative current.	N
CALibrate:INITial:CURRENT:PROTECTION:NEGative:MAXimum?	Returns the power-on default maximum value of negative overcurrent protection that can be set.	N
CALibrate:INITial:CURRENT:PROTECTION:NEGative:MINimum?	Returns the power-on default minimum value of negative overcurrent protection that can be set.	N
CALibrate:INITial:CURRENT:PROTECTION:POSitive <NRf>	Sets the power-on default positive overcurrent protection value.	N
CALibrate:INITial:CURRENT:PROTECTION:POSitive:MAXimum?	Returns the power-on default maximum value of positive overcurrent protection that can be set.	N
CALibrate:INITial:CURRENT:PROTECTION:POSitive:MINimum?	Returns the power-on default minimum value of positive overcurrent protection that can be set.	N
CALibrate:INITial:CURRENT:PROTECTION:POSitive?	Returns the power-on default power-on default positive overcurrent protection value.	N

COMMAND	DESCRIPTION	SCPI
CALibrate:INITial:MEAS:CURRent:AVERAGE <NR1>	Sets the number of readings to average together when returning the current value with the MEAS:CURR? command to reduce noise in the readback readings. Enter a value of 3 to 9, with the value of 3 (factory default) providing the fastest response time in the readings, but less rejection of noise.	N
CALibrate:INITial:MEAS:CURRent:AVERAGE?	Returns the number 3 to 9 to indicate the number of readings to average together when taking a current reading.	N
CALibrate:INITial:MEAS:VOLTag:e:AVERAGE <NR1>	Sets the number of readings to average together when returning the voltage value with the MEAS:VOLT? command to reduce noise in the readback readings. Enter a value of 1 to 10, with the value of 1 (factory default) providing the fastest response time in the readings, but less rejection of noise.	N
CALibrate:INITial:MEAS:VOLTag:e:AVERAGE?	Returns the number 1 to 10 to indicate the number of readings to average together when taking a current reading.	N
CALibrate:INITial:OPERating:MODE <SOUR ELOAD BIDIR BATSIM PVSI M BATTEST>	Changes the power-on default operating mode.	N
CALibrate:INITial:OPERating:MODE?	Returns the power-on default operating mode.	N
CALibrate:INITial:OUTPut:ISOLation <0 1>	Changes the power-on default state for output isolation relays.	N
CALibrate:INITial:OUTPut:ISOLation?	Returns the power-on default state for output isolation relays.	N
CALibrate:INITial:OUTPut:PROG ram:TYPE <0 1>	Changes the Output Programming type, valid arguments are: 0 – Voltage Programming type 1 – Current Programming type	N
CALibrate:INITial:OUTPut:PROG ram:TYPE?	Returns the Output Programming type	N
CALibrate:INITial:OUTPut:PROT ection:DELAY <NRf>	Sets the power-on default delay time for the protection.	N
CALibrate:INITial:OUTPut:PROT ection:DELAY?	Returns the power-on default delay time for the protection.	N
CALibrate:INITial:OUTPut:PROT ection:FOLD <NR1>	Sets the power-on default foldback protection setting. Valid arguments are same as for OUTP:PROT:FOLD.	N
CALibrate:INITial:OUTPut:PROT ection:FOLD?	Returns the power-on default setting of foldback protection.	N

COMMAND	DESCRIPTION	SCPI
CALibrate:INITial:OUTPut:SENS E <0/LOCAL 1/REMOTE>	Changes the power-on default method for sensing. Valid arguments are: 0 – Local sense 1 – Remote sense.	N
CALibrate:INITial:OUTPut:SENS E?	Returns the power-on default method for sensing.	N
CALibrate:INITial:PONS:DEFAUL T	Sets all the values to factory default.	N
CALibrate:INITial:POWER:MAXim um?	Returns the power-on default Maximum power that can be programmed with given Input voltage conditions.	N
CALibrate:INITial:POWER:MINim um?	Returns the power-on default Minimum power that can be programmed with given Input voltage conditions.	N
CALibrate:INITial:POWER:NEGat ive:LIMit <Nrf>	Sets the power-on default negative power limit.	N
CALibrate:INITial:POWER:NEGat ive:LIMit?	Returns the power-on default negative power limit.	N
CALibrate:INITial:POWER:NEGat ive:LIMit:MAXimum?	Returns the power-on default maximum value that the user can set for negative power limit.	N
CALibrate:INITial:POWER:NEGat ive:LIMit:MINimum?	Returns the power-on default minimum value that the user can set for negative power limit.	N
CALibrate:INITial:POWER:POSit ive:LIMit <Nrf>	Sets the power-on default positive power limit	N
CALibrate:INITial:POWER:POSit ive:LIMit?	Returns the power-on default positive power limit.	N
CALibrate:INITial:POWER:POSit ive:LIMit:MAXimum?	Returns the power-on default maximum value that the user can set for positive power limit.	N
CALibrate:INITial:POWER:POSit ive:LIMit:MINimum?	Returns the power-on default minimum value that the user can set for positive power limit.	N
CALibrate:INITial:POWER:PROTe ction:NEGat ive <Nrf>	Sets the power-on default negative overpower protection limit.	N
CALibrate:INITial:POWER:PROTe ction:NEGat ive?	Returns the power-on default negative overpower protection limit.	N
CALibrate:INITial:POWER:PROTe ction:NEGat ive:MAXimum?	Returns the power-on default maximum possible value for the negative overpower protection limit.	N
CALibrate:INITial:POWER:PROTe ction:NEGat ive:MINimum?	Returns the power-on default minimum possible value for the negative overpower protection limit.	N
CALibrate:INITial:POWER:PROTe ction:POSit ive <Nrf>	Sets the power-on default positive overpower protection limit.	N
CALibrate:INITial:POWER:PROTe ction:POSit ive?	Returns the power-on default positive overpower protection limit.	N
CALibrate:INITial:POWER:PROTe ction:POSit ive:MAXimum?	Returns the power-on default maximum possible value for the positive overpower protection limit.	N

COMMAND	DESCRIPTION	SCPI
CALibrate:INITial:POWer:PROTection:POSitive:MINimum?	Returns the power-on default minimum possible value for the positive overpower protection limit.	N
CALibrate:INITial:POWer:SLEW <Nrf>, <Nrf>	Sets the power-on default slew rate for the output power in terms of W/ms (first argument) or time in s (second argument).	N
CALibrate:INITial:POWer:SLEW:TYPE <0 1>	Sets the power-on default slew type for power.	N
CALibrate:INITial:POWer:SLEW:TYPE?	Returns the power-on default slew type for power.	N
CALibrate:INITial:POWer:SLEW?	Returns the slew rate set for the output power.	N
CALibrate:INITial:POWer:SOFT:LIMit:HIGH <Nrf>	Sets the power-on default higher power limit. For Example: In CV/CP mode, the value set for the higher power to regulate once the output power reaches this value.	N
CALibrate:INITial:POWer:SOFT:LIMit:HIGH?	Returns the power-on default higher power limit.	N
CALibrate:INITial:POWer:SOFT:LIMit:LOW <Nrf>	Sets the power-on default soft limit for lower power. For Example: In CP/CC mode, the maximum value that can be set for the output power to regulate.	N
CALibrate:INITial:POWer:SOFT:LIMit:LOW?	Returns the power-on default soft limit for lower power.	N
CALibrate:INITial:POWer?	Returns the power-on default power set to regulate.	N
CALibrate:INITial:REMOte:INHIBIT:INPUT:STATE <0/OFF 1/ON>	Sets the power-on default state for remote inhibit. Valid arguments are: 0 - OFF 1 - ON.	N
CALibrate:INITial:REMOte:INHIBIT:INPUT:STATE?	Returns the power-on default state for remote inhibit.	N
CALibrate:INITial:REMOte:INHIBIT:INPUT:TYPE <0/Contact Closure 1/Active SOurve>	Sets the power-on default type for remote inhibit. Valid arguments are: 0 - Contact Closure 1 - Active Source.	N
CALibrate:INITial:REMOte:INHIBIT:INPUT:TYPE?	Returns the power-on default type for remote inhibit.	N
CALibrate:INITial:REMOte:INHIBIT:MODE <0/OFF 1/LIVE 2/LATCHING>	Sets the power-on default mode for remote inhibit. Valid arguments are: 0 - OFF 1 - LIVE 2 - LATCH.	N
CALibrate:INITial:REMOte:INHIBIT:MODE?	Returns the power-on default mode for remote inhibit.	N

COMMAND	DESCRIPTION	SCPI
CALibrate:INITial:SERIES:RESISTANCE <Nrf>	Sets the power-on default series resistance.	N
CALibrate:INITial:SERIES:RESISTANCE:MAXimum?	Returns the power-on default maximum possible value for series resistance.	N
CALibrate:INITial:SERIES:RESISTANCE:MINimum?	Returns the power-on default minimum possible value for series resistance.	N
CALibrate:INITial:SERIES:RESISTANCE?	Returns the power-on default value for series resistance.	N
CALibrate:INITial:SINK:RESISTANCE <Nrf>	Sets the power-on default sink resistance value for which the unit behaves as constant resistive load (in eLoad Mode).	N
CALibrate:INITial:SINK:RESISTANCE:MAXimum?	Returns the power-on default value of maximum sink resistance possible.	N
CALibrate:INITial:SINK:RESISTANCE:MINimum?	Returns the power-on default value of minimum sink resistance possible.	N
CALibrate:INITial:SINK:RESISTANCE?	Returns the power-on default sink resistance value.	N
CALibrate:INITial:VOLTage <Nrf>	Sets the power-on default output voltage to be regulated.	N
CALibrate:INITial:VOLTage?	Returns the power-on default output voltage to be regulated.	N
CALibrate:INITial:VOLTage:HIGH:LIMit <Nrf>	Sets the power-on default higher limit of voltage. For Example: In CC/CV mode, the higher side voltage to be regulated once the output voltage reaches this value.	N
CALibrate:INITial:VOLTage:HIGH:LIMit?	Returns the power-on default higher limit of voltage	N
CALibrate:INITial:VOLTage:LOW:LIMit <Nrf>	Sets the power-on default lower limit of voltage. For Example: In CC/CV mode, the lower side voltage to be regulated once the output voltage reaches this value.	N
CALibrate:INITial:VOLTage:LOW:LIMit?	Returns the power-on default lower side voltage limit value set by the user.	N
CALibrate:INITial:VOLTage:MAXimum?	Returns the power-on default maximum voltage of the unit.	N
CALibrate:INITial:VOLTage:MINimum?	Returns the power-on default minimum voltage of the unit.	N
CALibrate:INITial:VOLTage:MONitor:FSC <Nrf>	Sets power-on default Full-scale voltage on voltage monitor pin (VMON), when power supply is producing full scale output voltage.	N
CALibrate:INITial:VOLTage:MONitor:FSC?	Returns the power-on default full-scale voltage set for Voltage monitor pin (VMON)	N

COMMAND	DESCRIPTION	SCPI
CALibrate:INITial:VOLTage:PROGram:FSC <NRf>	Sets the power-on default Full-scale voltage, at which Rated Voltage will be programmed in external Voltage programming Mode with voltage as programming source. Valid Range is from 5 to 10 V.	N
CALibrate:INITial:VOLTage:PROGram:FSC?	Returns the power-on default Full-scale Voltage, at which Rated Voltage will be programmed.	N
CALibrate:INITial:VOLTage:PROGram:FSCR <NRf>	Sets the power-on default Full-scale resistance, at which Rated Voltage will be programmed in external Voltage programming Mode with Current (Resistance) as programming source. Valid Range is from 5 to 10 kOhm.	N
CALibrate:INITial:VOLTage:PROGram:FSCR?	Returns the power-on default Full-scale Resistance, at which Rated Voltage will be programmed.	N
CALibrate:INITial:VOLTage:PROGram:SOUR <0 1>	Changes the power-on default source for the external analog voltage programming. Valid arguments are: 0 - voltage source 1 - Resistance source.	N
CALibrate:INITial:VOLTage:PROGram:SOUR?	Returns the power-on default selected source for the external analog voltage programming.	N
CALibrate:INITial:VOLTage:PROGram <0/INT 1/EXT>	Changes the power-on default Voltage programming mode of the supply. Valid arguments are: INT/0 - Internal Digital Voltage programming EXT/1 - External analog Voltage programming.	N
CALibrate:INITial:VOLTage:PROGram?	Returns the power-on default setting of Voltage programming mode.	N
CALibrate:INITial:VOLTage:PROTectioN <NRf>	Sets the power-on default overvoltage protection trip point in volts.	N
CALibrate:INITial:VOLTage:PROTectioN?	Returns the power-on default set overvoltage protection trip point in volts.	N
CALibrate:INITial:VOLTage:PROTectioN:FSC <NRf>	Sets the power-on default Full-scale voltage, at which Rated Overvoltage will be programmed in external Overvoltage programming Mode with voltage as programming source. Valid Range is from 5 to 10V.	N
CALibrate:INITial:VOLTage:PROTectioN:FSC?	Returns the power-on default Full-scale Voltage, at which Rated Overvoltage will be programmed.	N
CALibrate:INITial:VOLTage:PROTectioN:PROGram < 0/INT 1/EXT>	Changes the power-on default Overvoltage programming mode of the supply. Valid arguments are: INT/0 - Internal Digital Voltage programming EXT/1 - External analog Voltage programming.	N

COMMAND	DESCRIPTION	SCPI
CALibrate:INITial:VOLTage:PROtection:PROGram?	Returns the power-on default setting of Overvoltage programming mode.	N
CALibrate:INITial:VOLTage:SLEW <NRf>, <NRf>	Sets the power-on default slew rate for the output voltage in V/ms (first argument) or seconds (second argument).	N
CALibrate:INITial:VOLTage:SLEW:TYPE <0 1>	Sets the power-on default type of slew rate for the output voltage. 0 - V/ms 1 - second.	N
CALibrate:INITial:VOLTage:SLEW:TYPE?	Returns the power-on default type of slew rate for the output voltage.	N
CALibrate:INITial:VOLTage:SLEW?	Returns the power-on default slew rate for the output voltage.	N
CALibrate:INITial:VOLTage:SOFT:HIGH:LIMit <NRf>	Sets the power-on default maximum soft limit for the output voltage. For Example: In CV mode, the maximum possible voltage that can be set.	N
CALibrate:INITial:VOLTage:SOFT:HIGH:LIMit?	Returns the power-on default maximum soft limit for the output voltage.	N
CALibrate:INITial:VOLTage:SOFT:LOW:LIMit <NRf>	Sets the power-on default minimum soft limit for the output voltage. For Example: In CV mode, the maximum possible voltage that can be set.	N
CALibrate:INITial:VOLTage:SOFT:LOW:LIMit?	Returns the power-on default minimum soft limit for the output voltage.	N

Table 9-11. Cal INIT and PONS SCPI Command Reference

9.9 CALIBRATION SCPI COMMAND SUBSYSTEM

This section first presents a tree summary of the Calibration commands and then provides a tabular description.

9.9.1 CALIBRATION SCPI COMMAND SUMMARY

```

CALibrate
  :CURRent
  :CALCulate
  :ISOLation
  :VOLTage
  :SENSE
    :CALCulate
    :FIVEPOINT?
    :FIVEPOINT1 fval
    :FIVEPOINT2 fval
    :FIVEPOINT3 fval
    :FIVEPOINT4 fval

```

```

CALibrate
  :ISOLation
    :VOLTage
      :SENSE
        :FIVEPOINT5 fval
        :GAIN
        :GAIN?
        :OFFSet
        :OFFSet?
  :LOCK
  :MODule
    :CONFigure
    :CONFigure?
    :COUNT
      :CONFigure
      :CONFigure?
    :CURRent
      :LIMit
      :LIMit?
    :LASTCALDATE MM DD YYYY
    :LASTCALDATE?
    :MOD
      :SNUM?
    :POWER
      :DERating <fval>
      :DERating?
    :POWER
      :LIMit
      :LIMit?
    :SNUM
    :VOLTage
      :LIMit
      :LIMit?
  :MODule
    :CURRent?
    :NEXTCALDATE MM DD YYYY
    :NEXTCALDATE?
    :VOLTage
      :PROTection?
    :VOLTage?
  :OUTPut
    :CURRent
      :EXTI
        :GAIN
        :GAIN?
        :OFFSet
        :OFFSet?
      :EXTV
        :GAIN
        :GAIN?

```

```

CALibrate
:OUTPut
  :CURRent
    :EXTV
      :OFFSet
      :OFFSet?
      :POINT1
      :POINT2
      :POINTS?
    :FIVEPOINT1 fval
    :FIVEPOINT2 fval
    :FIVEPOINT3 fval
    :FIVEPOINT4 fval
    :FIVEPOINT5 fval
    :FIVEPOINT5?
    :GAIN
    :GAIN?
    :MONitor
      :FSC
      :FSC?
      :OFFSet
      :OFFSet?
    :OFFSet
    :OFFSet?
    :PERcentage <NR1>
    :PERcentage?
    :PROtection
      :NEGative
        :PERcentage
        :PERcentage <NR1>
      :POSitive
        :PERcentage
        :PERcentage <NR1>
  :OVERVOLTage
    :EXTV
      :FSC
      :GAIN?
      :OFFSet
      :OFFSet?
  :VOLTage
    :EXTI
      :FSC
      :GAIN?
      :OFFSet
      :OFFSet?
    :EXTV
      :FSC <NRf>
      :GAIN? fval
      :OFFSet
      :OFFSet?

```

```

CALibrate
  :OUTPut
    :VOLTage
      :FIVEPOINT1 fval
      :FIVEPOINT2 fval
      :FIVEPOINT3 fval
      :FIVEPOINT4 fval
      :FIVEPOINT5 fval
      :FIVEPOINTS?
      :GAIN
      :GAIN?
      :MONitor
        :FSC
        :FSC?
        :OFFS
        :OFFS?
      :OFFSet
      :OFFSet?
  :REMOTE
    :OUTPut
      :VOLTage
        :GAIN
        :GAIN?
        :OFFSet
        :OFFSet?
  :STORE
  :UNLock
  :VOLTage
    :CALCulate

```

9.9.2 CALIBRATION SCPI COMMAND REFERENCE

The letter “C” in the “SCPI” column means that the command syntax is SCPI compliant; an “N” in the “SCPI” column means that the command syntax is not part of the SCPI definition.

COMMAND	DESCRIPTION	SCPI
CALibrate:CURRENT:CALCulate	Calculates the value of gain and offset for the Current sense	N
CALibrate:ISOLATION:VOLTage:SENSE:CALCulate	Calculates the value of the gain and offset for isolated voltage sense.	N
CALibrate:ISOLATION:VOLTage:SENSE:FIVEPOINT?	Returns the entered values for 5-point calibration for isolated voltage sense.	N
CALibrate:ISOLATION:VOLTage:SENSE:FIVEPOINT1 <NRf>	Sets isolated voltage value for calibration point 1	N
CALibrate:ISOLATION:VOLTage:SENSE:FIVEPOINT2 <NRf>	Sets isolated voltage value for calibration point 2	N
CALibrate:ISOLATION:VOLTage:SENSE:FIVEPOINT3 <NRf>	Sets isolated voltage value for calibration point 3	N

COMMAND	DESCRIPTION	SCPI
CALibrate:ISOLATION:VOLTage:SENSE:FIVEPOINT4 <NRf>	Sets isolated voltage value for calibration point 4	N
CALibrate:ISOLATION:VOLTage:SENSE:FIVEPOINT5 <NRf>	Sets isolated voltage value for calibration point 5	N
CALibrate:ISOLATION:VOLTage:SENSE:GAIN <NRf>	Sets the value of the gain for the isolated voltage sense	N
CALibrate:ISOLATION:VOLTage:SENSE:GAIN?	Returns the value of the gain for the isolated voltage sense	N
CALibrate:ISOLATION:VOLTage:SENSE:OFFSET <NRf>	Sets the value of the offset for the isolated voltage sense.	N
CALibrate:ISOLATION:VOLTage:SENSE:OFFSET?	Returns the value of the offset for the isolated voltage sense.	N
CALibrate:LOCK	Disables access to the non-volatile memory. Prevents attempts to store calibration values. (Issue after CAL:UNLock and CAL:STORE commands).	N
CALibrate:MODule:CONFigure <0 1>	Configures the modules inside the chassis as parallel or series. Valid arguments are: 0 - Parallel 1 - Series.	N
CALibrate:MODule:CONFigure?	Returns the module configuration.	N
CALibrate:MODule:COUNT:CONFIGure <NR1>	Sets the number of modules present in the chassis (Maximum of 3).	N
CALibrate:MODule:COUNT:CONFIGure?	Returns the number of modules present in the chassis.	N
CALibrate:MODule:CURRent:LI Mit <NRf>	Sets the rated current limit of the modules.	N
CALibrate:MODule:CURRent:LI Mit?	Returns the rated current limit of the modules.	N
CALibrate:MODule:LASTCALDATE <MM DD YYYY>	Assigns the last calibration date; format: MM DD YYYY (space after MM and DD required)	N
CALibrate:MODule:LASTCALDATE?	Returns the last calibration date.	N
CALibrate:MOD:SNUM?	Returns the serial number of the module.	N
CALibrate:MODule:POWer:DERating <NRf>	Sets the power derating factor for the LOW_LINE AC input. For Low Line operation, output power is derated by 0.5.	N
CALibrate:MODule:POWer:DERating?	Returns the power derating factor.	N
CALibrate:MODule:POWer:LIMit <NRf>	Sets the rated power limit of the modules.	N
CALibrate:MODule:POWer:LIMit?	Returns the rated power limit of the modules.	N
CALibrate:MOD:SNUM <string>	Assigns the serial number of the module.	N
CALibrate:MODule:VOLTage:LI Mit <NRf>	Sets the rated voltage limit of the modules.	N

COMMAND	DESCRIPTION	SCPI
CALibrate:MODule:VOLTage:LI Mit?	Returns the rated voltage limit of the modules.	N
CALibrate:MODule:CURRent?	Returns the maximum current of the module.	N
CALibrate:MODule:NEXTCALDAT E <MM DD YYYY>	Sets the date next calibration is required; format: MM DD YYYY (space after MM and DD required)	N
CALibrate:MODule:NEXTCALDAT E?	Returns the date next calibration is required.	N
CALibrate:MODule:VOLTage:PR Otection?	Returns the maximum rated voltage of the module.	N
CALibrate:MODule:VOLTage?	Sets the maximum rated voltage of the module.	N
CALibrate:OUTPut:CURRent:EX TI:GAIN <NRf>	Sets the calibration full-scale point for current programming from external resistance source.	N
CALibrate:OUTPut:CURRent:EX TI:GAIN?	Returns the calibration full-scale point for current programming from external resistance source.	N
CALibrate:OUTPut:CURRent:EX TI:OFFSet <NRf>	Sets the calibration Offset point for current programming from external resistance source.	N
CALibrate:OUTPut:CURRent:EX TI:OFFSet?	Returns the calibration Offset point for current programming from external resistance source.	N
CALibrate:OUTPut:CURRent:EX TV:GAIN <NRf>	Sets the calibration Gain point for current programming from external voltage source.	N
CALibrate:OUTPut:CURRent:EX TV:GAIN?	Returns the calibration full-scale point for current programming from external voltage source.	N
CALibrate:OUTPut:CURRent:EX TV:OFFSet <NRf>	Sets the calibration Gain point for current programming from external voltage source.	N
CALibrate:OUTPut:CURRent:EX TV:OFFSet?	Returns the calibration Offset point for current programming from external voltage source.	N
CALibrate:OUTPut:CURRent:EX TV:POINT1 <NRf>	Sets the external voltage value-1 for current calibration.	N
CALibrate:OUTPut:CURRent:EX TV:POINT2 <NRf>	Sets the external voltage value-2 for current calibration.	N
CALibrate:OUTPut:CURRent:EX TV:POINTS?	Returns the external voltage value-1 for current calibration.	N
CALibrate:OUTPut:CURRent:FI VEPOINT1 <NRf>	Sets output current value for calibration point 1.	N
CALibrate:OUTPut:CURRent:FI VEPOINT2 <NRf>	Sets output current value for calibration point 2.	N
CALibrate:OUTPut:CURRent:FI VEPOINT3 <NRf>	Sets output current value for calibration point 3.	N
CALibrate:OUTPut:CURRent:FI VEPOINT4 <NRf>	Sets output current value for calibration point 4.	N
CALibrate:OUTPut:CURRent:FI VEPOINT5 <NRf>	Sets output current value for calibration point 5.	N
CALibrate:OUTPut:CURRent:FI VEPOINT?	Returns the entered values for 5-point calibration for current sense.	N

COMMAND	DESCRIPTION	SCPI
CALibrate:OUTPut:CURRent:GA IN <NRf>	Sets the value of the gain for the output current sense.	N
CALibrate:OUTPut:CURRent:GA IN?	Returns the value of the gain for the output current sense.	N
CALibrate:OUTPut:CURRent:MO Nitor:FSC <NRf>	Sets the calibration full-scale point for current monitor signal.	N
CALibrate:OUTPut:CURRent:MO Nitor:FSC?	Returns the calibration full-scale point for current monitor signal.	N
CALibrate:OUTPut:CURRent:MO Nitor:OFFSet <NRf>	Sets the calibration Offset point for current monitor signal.	N
CALibrate:OUTPut:CURRent:MO Nitor:OFFSet?	Returns the calibration Offset point for current monitor signal.	N
CALibrate:OUTPut:CURRent:OF FSet <NRf>	Sets the calibration Offset point for output current.	N
CALibrate:OUTPut:CURRent:OF FSet?	Returns the calibration Offset point for output current.	N
CALibrate:OUTPut:CURRent:PE Rcentage <NR1>	Sets the percentage of output current set for calibration.	N
CALibrate:OUTPut:CURRent:PE Rcentage?	Returns the percentage of output current set for calibration.	N
CALibrate:OUTPut:CURRent:PR OTection:NEGative:PERcentag e?	Returns the negative current protection limit in percentage during calibration.	N
CALibrate:OUTPut:CURRent:PR OTection:NEGative:PERcentag e <NR1>	Sets the negative current protection limit in percentage during calibration.	N
CALibrate:OUTPut:CURRent:PR OTection:POSitive:PERcentag e?	Returns the positive current protection limit in percentage during calibration.	N
CALibrate:OUTPut:CURRent:PR OTection:POSitive:PERcentag e <NR1>	Sets the positive current protection limit in percentage during calibration.	N
CALibrate:OUTPut:OVERVOLTag e:EXTV:FSC <NRf>	Sets the calibration full-scale point for overvoltage programming from external voltage source.	N
CALibrate:OUTPut:OVERVOLTag e:EXTV:GAIN?	Returns the gain for overvoltage programming from external voltage source.	N
CALibrate:OUTPut:OVERVOLTag e:EXTV:OFFSet <NRf>	Sets the offset for overvoltage programming from external voltage source.	N
CALibrate:OUTPut:OVERVOLTag e:EXTV:OFFSet?	Returns the offset for overvoltage programming from external voltage source.	N
CALibrate:OUTPut:VOLTag:e:EX TI:FSC <NRf>	Sets the calibration full-scale point for voltage programming from external resistance source.	N
CALibrate:OUTPut:VOLTag:e:EX TI:GAIN?	Returns the gain for voltage programming from external resistance source.	N

COMMAND	DESCRIPTION	SCPI
CALibrate:OUTPut:VOLTage:EX TI:OFFSet <NRf>	Sets the calibration full-scale point for voltage programming from external resistance source.	N
CALibrate:OUTPut:VOLTage:EX TI:GAIN?	Returns the gain for voltage programming from external resistance source.	N
CALibrate:OUTPut:VOLTage:EX TV:FSC <NRf>	Sets the calibration full-scale point for voltage programming from external voltage source.	N
CALibrate:OUTPut:VOLTage:EX TV:GAIN?	Returns the gain for voltage programming from external voltage source.	N
CALibrate:OUTPut:VOLTage:EX TV:OFFSet <NRf>	Sets the calibration full-scale point for voltage programming from external voltage source.	N
CALibrate:OUTPut:VOLTage:EX TV:OFFSet?	Returns the gain for voltage programming from external voltage source.	N
CALibrate:OUTPut:VOLTage:FI VEPOINT1 <NRf>	Sets output voltage value for calibration point 1.	N
CALibrate:OUTPut:VOLTage:FI VEPOINT2 <NRf>	Sets output voltage value for calibration point 2.	N
CALibrate:OUTPut:VOLTage:FI VEPOINT3 <NRf>	Sets output voltage value for calibration point 3.	N
CALibrate:OUTPut:VOLTage:FI VEPOINT4 <NRf>	Sets output voltage value for calibration point 4.	N
CALibrate:OUTPut:VOLTage:FI VEPOINT5 <NRf>	Sets output voltage value for calibration point 5.	N
CALibrate:OUTPut:CURRent:FI VEPOINT?	Returns the entered values for 5-point calibration for voltage sense.	N
CALibrate:OUTPut:VOLTage:GA IN <NRf>	Sets the value of the gain for the output voltage sense.	N
CALibrate:OUTPut:VOLTage:GA IN?	Returns the value of the gain for the output voltage sense.	N
CALibrate:OUTPut:VOLTage:MO Nitor:FSC <NRf>	Sets the calibration full-scale point for voltage monitor signal.	N
CALibrate:OUTPut:VOLTage:MO Nitor:FSC?	Returns the calibration full-scale point for voltage monitor signal.	N
CALibrate:OUTPut:VOLTage:MO Nitor:OFFS <NRf>	Sets the calibration Offset point for voltage monitor signal.	N
CALibrate:OUTPut:VOLTage:MO Nitor:OFFS?	Returns the calibration Offset point for voltage monitor signal.	N
CALibrate:OUTPut:VOLTage:OF FSet <NRf>	Sets the calibration Offset point for output voltage.	N
CALibrate:OUTPut:VOLTage:OF FSet?	Returns the calibration Offset point for output voltage.	N
CALibrate:REMOTE:OUTPut:VOL Tage:GAIN <NRf>	Sets the value of the gain for the output voltage at remote sense terminal.	N
CALibrate:REMOTE:OUTPut:VOL Tage:GAIN?	Returns the value of the gain for the output voltage at remote sense terminal.	N

COMMAND	DESCRIPTION	SCPI
CALibrate:REMOTE:OUTPut:VOL Tage:OFFSet <NRf>	Sets the value of the offset for the output voltage at remote sense terminal.	N
CALibrate:REMOTE:OUTPut:VOL Tage:OFFSet?	Returns the value of the offset for the output voltage at remote sense terminal.	N
CALibrate:STORe	Stores the calibration constants in non-volatile memory.	N
CALibrate:UNLock <string>	Sets the non-volatile memory available to store calibration constants. The access string is "6867".	N
CALibrate:VOLTage:CALCulate	Calculates the gain and offset for the voltage sense	N

Table 9-12. Calibration SCPI Command Reference

9.10 LIST SCPI COMMAND SUBSYSTEM

This section first presents a tree summary of the LIST commands and then provides a tabular description.

9.10.1 LIST SCPI COMMAND SUMMARY

```

LIST
  : "ADD <""filename29char"">"
  : CATalog?
  : COUNT
  : COUNT?
  : CURRent
  : CURRent
    : POINTS?
  : DElete
    : ALL
  : DWELL
    : POINTS?
  : DWELL <NRf+>
  : FILTER
    : SELECT
    : SELECT?
  : FILTER?
  : LINK
    : POINTS?
  : POINTS
    : COUNT
    : COUNT?
  : REPeat
    : POINTS?
  : RESISTANCE
    : POINTS?
  : SAVE
  : SELECT <""filename29char"">

```

```

LIST
  :SELECT?
  :STATE
  :STATE?
  :STATUS?
  :STEP
  :STEP?
  :TRIGGER
    :TYPE
    :TYPE?
  :TTLTRG
    :POINTS?
  :VOLTage
  :VOLTage
    :POINTS?

```

9.10.2 LIST SCPI COMMAND REFERENCE

The letter “C” in the “SCPI” column means that the command syntax is SCPI compliant; an “N” in the “SCPI” column means that the command syntax is not part of the SCPI definition.

COMMAND	DESCRIPTION	SCPI
LIST:ADD <string>	Creates the list with provided file name, file name can be alphanumeric up to 29 characters	N
LIST:CATalog?	Returns all the list file names present in the selected regulation and programming type	N
LIST:COUNT <NR1>	Sets the count value, i.e. Number of the times the selected list to be executed, Maximum value that can be entered is 65535, if the count value is -1, the list will be executed indefinite times	N
LIST:COUNT?	Returns the List count value	N
LIST:CURREnt <NRf>,<NRf>,...,<NRf>	Sets the values to the List Current points in amps	N
LIST:CURREnt:POINTS?	Returns the values of list current points in amps	N
LIST:DEL <String>	Deletes the provided list file name from the device	N
LIST:DEL:ALL	Deletes all the profiles present in the selected programming and output type	N
LIST:DWELL <NRf>,<NRf>,...,<NRf>	Sets the values to dwell points of the list in seconds	N
LIST:DWELL:POINTS?	Returns the dwell points of the selected list file in seconds	N
LIST:LINK <NR1>,<NR1>,...,<NR1>	Sets the values to link points of the list in the selected list file	N
LIST:LINK:POINTS?	Returns the link points of the selected list file	N
LIST:POINTS:COUNT <NR1>	Sets the value to number of points in the list file, maximum number of link points that can be set by the user are 50	N

COMMAND	DESCRIPTION	SCPI
LIST:POINTS:COUNT?	Returns the value of points count from the selected list file	N
LIST:REPeat <NR1>,<NR1>,...,<NR1>	Sets the values to the repeat count of each point	N
LIST:REPeat:POINTS?	Returns the values of the repeat count point of the selected list file	N
LIST:RESISTANCE <NR1>,<NR1>,...,<NR1>	Sets the values to series resistance points in the selected list file	N
LIST: RESISTANCE:POINTS?	Returns the values of the series resistance points in the selected list file	N
LIST:SAVE	Saves the selected list file to device	N
LIST:SELECT <string>	Selects the list file with provided file name	N
LIST:SELECT?	Returns the file name of the selected list file	N
LIST:STATE <IDLE/0 LOAD/1 RUN/3 Abort/4>	Sets the value to list state, RUN can be set only after the list file has been loaded and validated	N
LIST:STATE?	Returns the value of the list state 0 – Idle, 1 – Load, 3 – Run, 4 - Abort	N
LIST:STATUS?	Returns the status of the list. 0 – Idle, 1- Initializing, 2 – waiting for trigger, 3 – running, 4 – complete, 5 – Abort	N
LIST:STEP <0 1>	Sets the value to List step in the selected list file 0 – Auto Trigger 1 – Once Trigger	N
LIST:STEP?	Returns the value of the list step in the selected list file	N
LIST:TRIGGER:TYPE <0 1>	Sets the value to trigger type of the list in the selected list file 0 – Software trigger 1 – Hardware trigger	N
LIST:TRIGGER:TYPE?	Returns the value of the type of trigger in the selected list file	N
LIST:TTLTRG <0 1>,<0 1>,,,<0 1>	Sets the values to the output trigger points for each list data point. 0 – Trigger out disabled for the data point 1 – Trigger Out enabled for the data point	N
LIST:TTLTRG:POINTS?	Returns the values of the output trigger of each data in the selected list file	N
LIST:VOLTagE <NRf>,<NRf>,...,<NRf>	Sets the value to the voltage points of selected list file in volts	N
LIST:VOLTagE:POINTS?	Returns the Values of the voltage points in the selected list file in volts	N

Table 9-13. List SCPI Command Reference

9.11 MEASURE SCPI COMMAND SUBSYSTEM

This section first presents a tree summary of the Measure commands and then provides a tabular description.

9.11.1 MEASURE SCPI COMMAND SUMMARY

```

MEASure<n>
  :AHO?
  :ALL?
  :CURRent
    :average <val>
    :average?
    :PROGram?
    :TOTAL?
  :CURRent?
  :POWer
    :PROGram?
    :TOTAL?
  :POWer?
  :SOC?
  :VOLTage
    :average <val>
    :average?
    :PROGram?
    :PROTection
      :PROGram?
  :VOLTage?
  :WHO?

```

9.11.2 MEASURE SCPI COMMAND REFERENCE

The letter “C” in the “SCPI” column means that the command syntax is SCPI compliant; an “N” in the “SCPI” column means that the command syntax is not part of the SCPI definition.

COMMAND	DESCRIPTION	SCPI
MEASure:AHO?	Returns the floating value of Capacity in Ah	N
MEASure:ALL?	Returns Output Voltage in Volts, Output Current in Amps, Output Power in kW, MPPT Efficiency, Present SOC of the battery, Present Capacity of the battery in Ah, Energy in Wh	N
MEASure:CURRent:average <NR1>	Sets the number of readings to average together when returning the current value with the MEASure:CURRent? command to reduce noise in the readback readings. Enter a value of 1 to 10, with the value of 1 (factory default) providing the fastest response time in the readings, but less rejection of noise.	N

COMMAND	DESCRIPTION	SCPI
MEASure:CURRent:average?	Returns the number 1 to 10 to indicate the number of readings to average together when taking a current reading.	N
MEASure:CURRent:PROGram?	Returns the programmed output current from external Analog current programming feature.	N
MEASure:CURRent:TOTAL?	Returns the sum of all currents when multiple chassis are connected in parallel in amps	N
MEASure:POWer:PROGram?	Returns the programmed output power from external Analog current programming feature.	N
MEASure:POWer:TOTAL?	Returns the sum of power from individual chassis when multiple chassis are connected in parallel in amps	N
MEASure:CURRent?	Returns the floating-point value of the DC output current in amps.	C
MEASure:POWer?	Returns the floating-point value of the measured output power in kilowatts.	C
MEASure:SOC?	Returns the floating-point value of state of charge of the battery	N
MEASure:VOLtage:average <NR1>	Sets the number of readings to average together when returning the voltage value with the MEASure:Voltage? command to reduce noise in the readback readings. Enter a value of 1 to 10, with the value of 1 (factory default) providing the fastest response time in the readings, but less rejection of noise.	N
MEASure:VOLtage:average?	Returns the number 1 to 10 to indicate the number of readings to average together when taking a current reading.	N
MEASure:VOLtage:PROGram?	Returns the programmed output voltage from external Analog current programming feature.	N
MEASure:VOLtage:PROtection:PROGram?	Returns the programmed Over voltage trip point from external Analog over voltage programming feature.	N
MEASure:VOLtage?	Returns the floating-point value of the DC output voltage in volts.	C
MEASure:WHO?	Returns the floating-point value of the energy in watt-hour	N

Table 9-14. Measure SCPI Command Reference

9.12 OUTPUT SCPI COMMAND SUBSYSTEM

This section first presents a tree summary of the Output commands and then provides a tabular description.

9.12.1 OUTPUT SCPI COMMAND SUMMARY

OUTP

```

:ISOLation bval
:ISOLation?
:POLarity bval
:POLarity?
:PROGram
  :TYPE
  :TYPE?
:PROTection
  :CLEAR
  :DELAY fval
  :DELAY?
  :FOLD <ival>
  :FOLD?
:REMote
  :INHIBIT
    :INPUT
      :STATE
      :STATE?
      :TYPE
      :TYPE?
    :MODE
    :MODE?
:SENSe <remote
:SENSe?
:STATe?
:STATe bval
:TRIP?

```

9.12.2 OUTPUT SCPI COMMAND REFERENCE

The letter “C” in the “SCPI” column means that the command syntax is SCPI compliant; an “N” in the “SCPI” column means that the command syntax is not part of the SCPI definition.

COMMAND	DESCRIPTION	SCPI
OUTP:ISOLation <OPEN/0 CLOSED/1>	Sets the rear panel isolation relay control signal ON or OFF. Valid arguments are 1/ON or 0/OFF.	N
OUTP:ISOLation?	Returns the state of the rear panel isolation relay control signal: 0 – OFF 1 – ON	N
OUTPut:POLarity<NORM/0/OFF INV/1/ON>	Changes the state of the polarity relay signal. This command requires that the isolation relay be open beforehand	C
OUTPut:POLarity?	Returns the state of the polarity relay: <NORM INV>	C
OUTPut:PROGram:TYPE <VOLT/0 CURR/1>	Sets the Output programming type. Valid arguments are 1/Current and 0/Voltage	N
OUTPut:PROGram:TYPE?	Returns the output programming type:<VOLT CURR>	N
OUTPut:PROTection:CLEAR	Clears the faults occurred due to protection settings	N

COMMAND	DESCRIPTION	SCPI
OUTPut:PROTection:DELaY <NRf>	Sets the programmable time delay executed by the supply before reporting output protection conditions after a new output voltage or current is specified.	N
OUTPut:PROTection:DELaY?	Returns the time delay to be executed by the supply..	
OUTPut:PROTection:FOLD <NR1>	Sets the Foldback setting of the supply, valid arguments are 0 to 12	N
OUTPut:PROTection:FOLD?	Returns the Foldback setting of the supply	N
OUTPut:REMOte:INHIBIT:INPUt:STA TE <0 1>	Sets the input state of the remote inhibit, valid arguments are 0(Open) or 1(Close)	N
OUTPut:REMOte:INHIBIT:INPUt:STA TE?	Returns the input state of the remote inhibit :<Open Close>	N
OUTPut:REMOte:INHIBIT:INPUt:TYP E <0 1>	Sets the input type of the remote inhibit, valid arguments are 0(Contact Closure) or 1(Active Source)	N
OUTPut:REMOte:INHIBIT:INPUt:TYP E?	Returns the input state of the remote inhibit :<Contact Closure Active Source>	N
OUTPut:REMOte:INHIBIT:MODE <OFF/0 LIVE/1 LATCHING/2>	Sets the mode of the remote inhibit. Valid Arguments are 0 – OFF, 1 – LIVE, 2 - LATCHING	N
OUTPut:REMOte:INHIBIT:MODE?	Returns the mode of remote inhibit.	N
OUTPut:SENSe <REMOTE/0 LOCAL/1>	Sets the output voltage sense signal setting. Valid arguments are 1/REMOTE or 0/LOCAL. When REMOTE option is selected, voltage sense signal must be connected at RVS connector at the rear side of power supply.	N
OUTPut:SENSe?	Returns the setting of the output voltage sense signal.	N
OUTPut:STATe <Boolean>	Sets the output to zero or the programmed value; opens or closes the isolation relay. Valid arguments are 1/ON or 0/OFF. *RST state value is ON.	C
OUTPut:STATe?	Returns the state of the output: 1 - ON 0 - OFF	C
OUTPut:TRIP?	Returns the integer value 1 - TRIPPED or 0 - UNTRIPPED state of the output.	N

Table 9-15. Output SCPI Command Reference

9.13 TRIGGER SCPI COMMAND SUBSYSTEM

This section first presents a tree summary of the Trigger commands and then provides a tabular description.

9.13.1 TRIGGER SCPI COMMAND SUMMARY

```
TRIGer<n>
    :ABORT
    :SOFT
```

9.13.2 TRIGGER SCPI COMMAND REFERENCE

The letter “C” in the “SCPI” column means that the command syntax is SCPI compliant; an “N” in the “SCPI” column means that the command syntax is not part of the SCPI definition.

COMMAND	DESCRIPTION	SCPI
TRIGer:SOFT	Sets the Software trigger for RAMP and LIST functions.	N
TRIG:abort	Stops the Ramp and List function, sets the output voltage or current to present value based on the output regulation type.	N

Table 9-16. Trigger SCPI Command Reference

9.14 STATUS SCPI COMMAND SUBSYSTEM

This section first presents a tree summary of the Status commands and then provides a tabular description.

9.14.1 STATUS SCPI COMMAND SUMMARY

```
STATUS<n>
    :FAULT
        :CHASSIS?
        :STATUS?
    :MODule<n>
        :FAULT?
```

9.14.2 STATUS SCPI COMMAND REFERENCE

The letter “C” in the “SCPI” column means that the command syntax is SCPI compliant; an “N” in the “SCPI” column means that the command syntax is not part of the SCPI definition.

COMMAND	DESCRIPTION	SCPI
STATUS:FAULT:CHASSIS?	Returns the fault status of all chassis connected in parallel, each bit represents the fault status of each individual chassis	N
STATUS:FAULT:STATUS?	Returns the System faults	N
STATUS:MODULE<1 2 3>:FAULT?	Returns the status of faults of the specified module	N

Table 9-17. Status SCPI Command Reference

9.15 SYSTEM SCPI COMMAND SUBSYSTEM

This section first presents a tree summary of the System commands and then provides a tabular

description.

9.15.1 SYSTEM SCPI COMMAND SUMMARY

```

SYSTem<n>
  :CHASSIS
    :ADDRESS?
  :ENUM
    :COUNT?
  :FAULT
    :STATUS?
  :MODULE
    :COUNT?
  :MODULE<n>
    :STATUS?
      :TEMPerature
        :FAULT
          :STATUS?
  :OPERATING
    :MODE
    :MODE?
  :OUTPut
    :REGULATION
    :FAULT?
  :REV?
  :ERRor?
  :LOCAL <boolean>
  :LOCAL?
  :NET
    :AUTOIP <boolean>
    :AUTOIP?
    :DESC <string>
    :DESC?
    :DHCPMODE <boolean>
    :DHCPMODE?
    :DNS <string>
    :DNS?
    :GATE <string>
    :GATE?
    :HOST <string>
    :HOST?
    :IP <string>
    :IP?
    :LANLED <boolean>
    :LANLED?
    :MAC?
    :MASK <string>
    :MASK?
    :NETBUTTON <string>
    :PORT <NRf>
    :PORT?

```

```

SYSTEM<n>
  :NET
    :TERM <NRf>
    :TERM?

```

9.15.2 SYSTEM SCPI COMMAND REFERENCE

The letter “C” in the “SCPI” column means that the command syntax is SCPI compliant; an “N” in the “SCPI” column means that the command syntax is not part of the SCPI definition.

COMMAND	DESCRIPTION	SCPI
SYSTEM:CHASSIS:ADDRESS?	Returns the chassis address	N
SYSTEM:ENUM:COUNT?	Returns number of chassis connected in parallel	N
SYSTEM:FAULT:STATUS?	Returns the system fault status	N
SYSTEM:MODULE:COUNT?	Returns the number of modules present inside the chassis	
SYSTEM<n>:MODULE<1 2 3>:TEMPerature:FAULT:STATUS?	Returns the temperature fault status of specified module	N
SYSTEM:OPERATING:MODE <SOUR ELOAD BIDIR BATSIM PVSIM BATTEST>	Sets the operating mode of the system	N
SYSTEM:OPERATING:MODE?	Returns the operating mode of the system: :<0/SOUR 1/BIDIR 2/ELOAD 3/BATSIM 4/PVSIM 5/BATTEST>	N
SYSTEM<n>:OUTPut:REGULATION:FAULT?	Returns the foldback faults of the system	N
SYSTEM<n>:REV?	Returns the firmware revision number of the all the controller	N
SYSTEM:ERRor?	Queries Error Queue for next error/event entry (first in, first out). Entries contain an error number and descriptive text. A 0-return value indicates no error occurred; negative numbers are reserved by SCPI. The maximum return string length is 255 characters. The queue holds up to 10 error/entries. All entries are cleared by the *CLS command.	C
SYSTEM:LOCAL <boolean>	Forces the supply to local or remote state. <ON> or <1> sets operation to local mode. <OFF> or <0> sets the operation to remote mode.	N
SYSTEM:LOCAL?	Returns ON or 1 if in local mode. Returns OFF or 0 if in remote mode.	N
SYST:NET:AUTOIP <boolean>	Sets the network Auto IP mode in the Primary configuration without affecting the Secondary configuration. 0 - disable AutoIP; 1 - enable AutoIP	N
SYST:NET:AUTOIP?	Returns 1 if AutoIP is enabled in the Primary configuration. Returns 0 if AutoIP is disabled in the Primary configuration.	N

COMMAND	DESCRIPTION	SCPI
SYST:NET:DESC <string>	Set the network Description, a 36-character alphanumeric string	N
SYST:NET:DESC?	Returns the network Description.	N
SYST:NET:DHCPMODE <boolean>	Sets the network DHCP Mode in the Primary configuration without affecting the Secondary configuration. 0 - disable DHCP; 1 - enable DHCP	N
SYST:NET:DHCPMODE?	Returns 1 if DHCP Mode is enabled in the Primary configuration. Returns 0 if DHCP mode is disabled in the Primary configuration.	N
SYST:NET:DNS <string>	Sets the network DNS IP address for the device. String is in the format "NNN.NNN.NNN.NNN" where "NNN" = 0 through 255, inclusive.	N
SYST:NET:DNS?	Returns the network DNS address for the device.	N
SYST:NET:GATE <string>	Sets the network gateway IP address for the device. String is in the format "NNN.NNN.NNN.NNN" where "NNN" = 0 through 255, inclusive.	N
SYST:NET:GATE?	Returns the network gateway IP address for the device.	N
SYST:NET:HOST <string>	Set the network Host Name, a 15-character (maximum) alphanumeric string. (Must be limited to 15 characters for LXI compliance)	N
SYST:NET:HOST?	Returns the network Host Name	N
SYST:NET:IP <string>	Sets the Primary configuration to STATICIP mode and sets the network IP address for the device. String is in the format "NNN.NNN.NNN.NNN" where "NNN" = 0 through 255, inclusive.	N
SYST:NET:IP?	Returns two IP addresses: the first is the IP address set to be used when the system boots up; the second is the IP address presently in use by the power supply. (The first address will either be 0.0.0.0. if the Primary configuration is DHCP or DHCP+AUTOIP, or it will be the static IP last specified).	N
SYST:NET:LANLED:BLINK <string>	ON changes front panel screen to device identify. OFF changes to dashboard screen.	N
SYST:NET:MAC?	Returns the network MAC address. xx:xx:xx:xx:xx:xx (Hexadecimal digit pairs)	N
SYST:NET:MASK <string>	Set the network Subnet Mask for the device. String is in the format "NNN.NNN.NNN.NNN" where "NNN" = 0 through 255, inclusive.	N
SYST:NET:MASK?	Returns the network Subnet Mask for the device.	N

COMMAND	DESCRIPTION	SCPI
SYST:NET:NETBUTTON <string>	Returns configuration parameters to factory default. (Software equivalent of pressing the Reset switch on the rear panel of the power supply). You must cycle the power to effect the change. The access string is "6867."	N
SYST:NET:PORT <Nrf>	Set the network TCP/IP socket listening port. Valid values are 1025 to 65535.	N
SYST:NET:PORT?	Returns the network TCP/IP socket listening port.	N
SYST:NET:TERM <Nrf>	Sets the incoming string termination character to be used by the device. Factory set to 3. The valid range is 1-4. Values indicate the following terminator(s): 1 - 0x0d only (CR), 2 - 0x0a only (LF), 3 - 0x0d 0x0a (CR LF), 4 - 0x0a 0x0d (LF CR)	N
SYST:NET:TERM?	Returns the string terminators to be used by the device.	N

Table 9-18. System SCPI Command Reference

This page intentionally left blank

10

CALIBRATION

This chapter provides the procedures required to calibrate the Mi-Beam power supply. It is recommended that calibration should be performed at 12-month intervals, or following service if subassemblies are replaced. The procedures are performed using SCPI commands through the remote digital interface using either the Virtual Panels GUI program or another suitable communication program.

10.1 CALIBRATION EQUIPMENT



Table 10-1 lists the equipment needed to conduct the calibration procedure.

EQUIPMENT	MODEL
DMM	Fluke 8558A
Data Acquisition/Switch UUT	Agilent 34980A with 34980A Multiplexer
Oscilloscope	Tektronix MDO34 3-BW-200
Shunt High Accuracy	100A (Guildline 9230A-100)
AC Source 45kVA	AMETEK SQ0045C1D1-000000
DC Power Supply Bidirectional	ITECH IT6018C-2250-25
DC Hi-pot Tester	0-3100Vdc, 2 mA trip current
Computer Controller	RS232, USB, and Ethernet cards
Final Test Fixture	5580240-01R
Differential probe	Tektronix, THDP0100

Table 10-1. Calibration Equipment

10.2 CALIBRATION PROCEDURES

10.2.1 PREPARATION FOR CALIBRATION

	<p>WARNING!</p> <p>Hazardous voltages exist at the rear side of the power supply; avoid contact with the AC input and AC/DC output terminals and be aware that filter capacitors store potentially dangerous energy for some time after power is removed.</p>
	<p>TECHNICIAN SYMBOL</p> <p>Only qualified personnel should perform maintenance or service tasks.</p>

The calibration procedures require precision instrumentation to measure voltage and current; when substituting for the recommended test equipment, ensure that the accuracy is adequate so

that excessive error is not incurred, compared to the specifications of the parameters that are to be calibrated. To set up the alignment procedures, perform the following initial steps:

- a) Disconnect the UUT AC input power.
- b) Disconnect all loads from the UUT's output terminals.
- c) Connect the UUT sense lines to the output terminals.
- d) Connect the DVM to the UUT output terminals.
- e) Set the UUT to REMOTE mode by the rear panel Remote or Local Configuration Switch.
- f) Perform one of the following:
 - For **RS232**: Connect the RS232 controller to the rear panel of the UUT using the RS232 null modem cable.
 - For **Ethernet**: Set up the Ethernet communication by connecting the Ethernet cable to the rear panel of the UUT.
- g) Reconnect the AC input power. Turn the unit ON and allow the unit to warm up for at least 30 minutes.

10.2.2 LOCAL SENSE VOLTAGE PROGRAMMING CALIBRATION

- a) Perform the calibration in no load condition.
- b) Configure the UUT to Voltage programming type and regulation into CV by sending the command:
 - OUTP: PROG: TYPE VOLT
 - OUTP: PROT: FOLD CV
- c) Set the current and over voltage protection value to 100%, and sense to local by sending the SCPI commands:

```
OUTP: SENS 0
CAL: OUTP: CURR: PROT: POS: PER 100
CAL: OUTP: CURR: PROT: NEG: PER 100
CAL: OUTP: VOLT: PROT: PER 100
```

- d) Enable the Output of the UUT:
 - OUTP: STAT 1
- e) Set the voltage value to 5% by sending the SCPI command:

```
CAL: OUTP: VOLT: PER 5
```

- f) Measure the output voltage using a DMM. It should be approximately 5% of the rated output voltage. Set the 1st point of the calibration by sending the command:

```
CAL: OUTP: VOLT: FIVEPOINT 1 <data>
```

NOTE: where '<data>' is the measured output voltage from the DMM.

- g) Set the voltage value to 25% by sending the SCPI command:

```
CAL: OUTP: VOLT: PER 25
```

- h) Measure the output voltage using a DMM. It should be approximately 25% of the rated output voltage. Set the 2nd point of the calibration by sending the command:

```
CAL: OUTP: VOLT: FIVEPOINT 2 <data>
```

NOTE: where '<data>' is the measured output voltage from the DMM.

- i) Set the voltage value to 50% by sending the SCPI command:

```
CAL: OUTP: VOLT: PER 50
```

- j) Measure the output voltage using a DMM. It should be approximately 50% of the rated output voltage. Set the 3rd point of the calibration by sending the command:

```
CAL: OUTP: VOLT: FIVEPOINT 3 <data>
```

NOTE: where '<data>' is the measured output voltage from the DMM.

- k) Set the voltage value to 75% by sending the SCPI command:

```
CAL: OUTP: VOLT: PER 75
```

- l) Measure the output voltage using a DMM. It should be approximately 75% of the rated output voltage. Set the 4th point of the calibration by sending the command:

```
CAL: OUTP: VOLT: FIVEPOINT 4 <data>
```

NOTE: where '<data>' is the measured output voltage from the DMM.

- m) Set the voltage value to 100% by sending the SCPI command:

```
CAL: OUTP: VOLT: PER 100
```

- n) Measure the output voltage using a DMM. It should be approximately 100% of the rated output voltage. Set the 5th point of the calibration by sending the command:

```
CAL: OUTP: VOLT: FIVEPOINT 5 <data>
```

NOTE: where '<data>' is the measured output voltage from the DMM.

- o) Set the voltage DAC to zero and store the calibrated value by sending the following SCPI commands:

```
CAL: OUTP: VOLT: PER 0
CAL: OUTP: VOLT: FIVEPOINT?
OUTP: STAT 0
CAL: OUTP: VOLT: CALC
CAL: UNLOCK "6867"
CAL: STORE
CAL: LOCK
```

- p) Program the DC bidirectional power supply output voltage to 0 V and disable the output.

10.2.3 REMOTE SENSE VOLTAGE PROGRAMMING CALIBRATION

- a) Perform the calibration in no load condition.
- b) Configure the UUT to Voltage programming type and regulation into CV by sending the commands:

```
OUTP: PROG: TYPE VOLT
OUTP: PROT: FOLD CV
```

- c) Set the current and over voltage protection value to 100%, and sense to remote by sending the SCPI commands:

```
OUTP: SENS 1
CAL: OUTP: CURR: PROT: POS: PER100
CAL: OUTP: CURR: PROT: NEG: PER100
CAL: OUTP: VOLT: PROT: PER 100
```

- d) Enable the Output of the UUT:

```
OUTP: STAT 1
```

- e) Set the voltage value to 5% by sending the SCPI command:

```
CAL: OUTP: VOLT: PER 5
```

- f) Measure the output voltage using a DMM. It should be approximately 5% of the rated output voltage. Set the 1st point of the calibration by sending the command:

```
CAL: OUTP: VOLT: FIVEPOINT 1 <data>
```

NOTE: where '<data>' is the measured output voltage from the DMM.

- g) Set the voltage value to 25% by sending the SCPI command:

```
CAL: OUTP: VOLT: PER 25
```

- h) Measure the output voltage using a DMM. It should be approximately 25% of the rated output voltage. Set the 2nd point of the calibration by sending the command:

```
CAL: OUTP: VOLT: FIVEPOINT 2 <data>
```

NOTE: where '<data>' is the measured output voltage from the DMM.

- i) Set the voltage value to 50% by sending the SCPI command:

```
CAL: OUTP: VOLT: PER 50
```

- j) Measure the output voltage using a DMM. It should be approximately 50% of the rated output voltage. Set the 3rd point of the calibration by sending the command:

```
CAL: OUTP: VOLT: FIVEPOINT 3 <data>
```

NOTE: where '<data>' is the measured output voltage from the DMM.

- k) Set the voltage value to 75% by sending the SCPI command:

```
CAL: OUTP: VOLT: PER 75
```

- l) Measure the output voltage using a DMM. It should be approximately 75% of the rated output voltage. Set the 4th point of the calibration by sending the command:

```
CAL: OUTP: VOLT: FIVEPOINT 4 <data>
```

NOTE: where '<data>' is the measured output voltage from the DMM.

- m) Set the voltage value to 100% by sending the SCPI command:

```
CAL: OUTP: VOLT: PER 100
```

- n) Measure the output voltage using a DMM. It should be approximately 100% of the rated output voltage. Set the 5th point of the calibration by sending the command:

```
CAL: OUTP: VOLT: FIVEPOINT 5 <data>
```

NOTE: where '<data>' is the measured output voltage from the DMM.

- o) Set the voltage DAC to zero and store the calibrated value by sending following SCPI commands:

```
CAL: OUTP: VOLT: PER 0  
CAL: OUTP: VOLT: FIVEPOINT?  
OUTP: STAT 0  
CAL: OUTP: VOLT: CALC  
CAL: UNLOCK "6867"  
CAL: STORE  
CAL: LOCK
```

p) Program the DC bidirectional power supply output voltage to 0 V and disable the output.

10.2.4 CURRENT PROGRAMMING CALIBRATION

a) Connect the DC bidirectional power supply (ITECH) as load to the output of the UUT and Current Shunt in series.

b) Connect the DMM to the sense terminals of the Current Shunt.

c) Configure the DC bidirectional power supply to voltage priority and set Positive current limit, Negative current limit, and voltage as follows:

- Set Current positive = 101% FSC of the UUT
- Set Current negative = - 101% FSC of the UUT
- Set Voltage = 30% of the UUT rated

d) Configure the UUT programming type into Current and regulation settings into CC/CV.

```
OUTP: PROG: TYPE CURR
OUTP: PROT: FOLD CCCV
```

e) Set the DAC value of the over voltage to 35% of the rated voltage, enable the output of the UUT by sending the SCPI commands:

```
CAL: OUTP: VOLT: PROT: PER 35
CAL: OUTP: CURR: PROT: POS: PER 100
CAL: OUTP: CURR: PROT: NEG: PER 100
OUTP: STAT 1
```

f) Set the output current to -90% for the 1st Point, by sending SCPI command:

```
CAL: OUTP: CURR: PER -90
```

g) Measure the output voltage of the shunt using the DMM and calculate output current, Set the 1st point of the calibration by sending the command:

```
CAL: OUTP: CURR: FIVEPOINT 1 <data>
```

NOTE: where '<data>' is the calculated output current from DMM value.

h) Set the output current to -40% for the 2nd Point, by sending SCPI command:

```
CAL: OUTP: CURR: PER -40
```

i) Measure the output voltage of the shunt using the DMM and calculate output current, Set the 2nd point of the calibration by sending the command:

```
CAL: OUTP: CURR: FIVEPOINT 2 <data>
```

NOTE: where '<data>' is the calculated output current from DMM value.

- j) Set the resistance for the 3rd Point and current DAC value to 0%, by sending SCPI command:

```
CAL: OUTP: CURR: PER 0
```

- k) Measure the output voltage of the shunt using the DMM and calculate output current, Set the 3rd point of the calibration by sending the command:

```
CAL: OUTP: CURR: FIVEPOINT 3 <data>
```

NOTE: where '<data>' is the calculated output current from DMM value.

- l) Set the resistance for the 4th Point and current DAC value to 30%, by sending SCPI command:

```
CAL: OUTP: CURR: PER 30
```

- m) Measure the output voltage of the shunt using the DMM and calculate output current, Set the 4th point of the calibration by sending the command:

```
CAL: OUTP: CURR: FIVEPOINT 4 <data>
```

NOTE: where '<data>' is the calculated output current from DMM value.

- n) Set the resistance for the 5th Point and current DAC value to 90%, by sending SCPI command:

```
CAL: OUTP: CURR: PER 90
```

- o) Measure the output voltage of the shunt using the DMM and calculate output current, Set the 5th point of the calibration by sending the command:

```
CAL: OUTP: CURR: FIVEPOINT 5 <data>
```

NOTE: where '<data>' is the calculated output current from DMM value.

- p) Set the current DAC to zero and store the calibrated value by sending the following SCPI commands:

```
CAL: OUTP: CURR: PER 0
CAL: OUTP: CURR: CALC
CAL: OUTP: CURR: FIVEPOINT?
OUTP: STAT 0
CAL: UNLOCK "6867"
CAL: STORE
CAL: LOCK
```

- q) Program the DC bidirectional power supply output voltage to 0V and disable the output

10.2.5 ANALOG PROGRAM ADJUSTMENT

Analog programming ports can be calibrated with set of commands as described in below section. For detailed Pin description of the Analog programming connector and connection diagram, Refer to Section 8.2.

a) Preparation:

- Power down the Unit Under Test (UUT) and remove the input power for safety.
- Allow 5 minutes for the energy in the output to bleed down to a safe level.
- Locate the Analog Programming connector at the rear end of the power supply.

Connect a DC voltage source to PIN numbers required for the Calibration procedure that is to be performed or connect Resistor as a load for 1mA constant current source if the selected calibration procedure is on Resistance programming.

10.2.5.1 VOLTAGE PROGRAMMING – 10 V RANGE VOLTAGE SOURCE CALIBRATION

- a) Configure the voltage programming mode to internal, reference source as voltage and FSC to 10V by send the following SCPI commands:

```
OUTP:STAT OFF
SOUR:VOLT:PROG INT
SOUR:VOLT:PROG:SOUR VOLT
SOUR:VOLT:PROG:FSC 10
```

- b) Apply zero volts across rear panel DB26 connector pin VPRG_VOLT and return (pin 1 and 6) and send below command to calibrate the offset.

```
CAL:OUTP:VOLT:EXTV:OFFS
```

- c) Apply 10 volts across rear panel DB26 connector pin VPRG_VOLT and return (pin 1 and 6) and send below command to calibrate the gain).

```
CAL:OUTP:VOLT:EXTV:FSC
```

- d) Store the calibration by sending the below commands.

```
CAL:UNLOCK "6867"
CAL:STORE
```



```
CAL:LOCK
```

10.2.5.2 VOLTAGE PROGRAMMING – 5V RANGE VOLTAGE REFERENCE SOURCE CALIBRATION

- a) Configure the voltage programming mode to internal, reference source as voltage and FSC to 10V by send the following SCPI commands:

```
OUTP:STAT OFF  
SOUR:VOLT:PROG INT  
SOUR:VOLT:PROG:SOUR VOLT  
SOUR:VOLT:PROG:FSC 5
```

- b) Apply zero volts across rear panel DB26 connector pin VPRG_VOLT and return (pin 1 and 6) and send below command to calibrate the offset.

```
CAL:OUTP:VOLT:EXTV:OFFS
```

- c) Apply 5 volts across rear panel DB26 connector pin VPRG_VOLT and return (pin 1 and 6) and send below command to calibrate the gain).

```
CAL:OUTP:VOLT:EXTV:FSC
```

- d) Store the calibration by sending the below commands.

```
CAL:UNLOCK "6867"  
CAL:STORE  
CAL:LOCK
```

10.2.5.3 VOLTAGE PROGRAMMING – CURRENT SOURCE 10K OHMS RANGE (RESISTANCE PROGRAMMING) CALIBRATION

- a) Configure the voltage programming mode to internal, reference source as current and FSCR to 10K Ohms by send the following SCPI commands:

```
OUTP:STAT OFF  
SOUR:VOLT:PROG INT  
SOUR:VOLT:PROG:SOUR CURR
```

```
SOUR:VOLT:PROG:FSCR 10
```

- b) Connect a zero-ohm resistor across rear panel DB26 connector pin VPRG_CURR and return (pin 2 and 6) and send below command to calibrate the offset.

```
CAL:OUTP:VOLT:EXTI:OFFS
```

- c) Connect a 10.0K ohms resistor across rear panel DB26 connector pin VPRG_CURR CURR and return (pin 2 and 6) and send the command below to calibrate the gain.

- d) Send the commands:

```
CAL:OUTP:VOLT:EXTI:FSC
```

- e) Store the calibration by sending the below commands.

```
CAL:UNLOCK "6867"  
CAL:STORE  
CAL:LOCK
```

10.2.5.4 OVER-VOLTAGE PROGRAMMING – 10 V VOLTAGE SOURCE CALIBRATION

- a) Configure the over voltage programming mode to internal and FSC to 10V by send the following SCPI commands:

```
OUTP:STAT OFF  
SOUR:VOLT:PROT:PROG INT  
SOUR:VOLT:PROT:PROG:FSC 10
```

- b) Apply zero volts across rear panel DB26 connector pin OVPPRG_VOLT and return (pin 5 and 6) and send below command to calibrate the offset.

```
CAL:OUTP:OVERVOLT:EXTV:OFFS
```

- c) Apply 10.0 volts across rear panel DB26 connector pin OVPPRG_VOLT and return (pin 5 and 6) and send below command to calibrate the gain.

```
CAL:OUTP:OVERVOLT:EXTV:FSC
```

- d) Store the calibration by sending the below commands.

```
CAL:UNLOCK "6867"  
CAL:STORE  
CAL:LOCK
```

10.2.5.5 OVER-VOLTAGE PROGRAMMING – 5V VOLTAGE SOURCE CALIBRATION

- a) Configure the over voltage programming mode to internal and FSC to 5V by send the following SCPI commands:

```
OUTP:STAT OFF  
SOUR:VOLT:PROT:PROG INT  
SOUR:VOLT:PROT:PROG:FSC 5
```

- b) Apply zero volts across rear panel DB26 connector pin OVPPRG_VOLT and return (pin 5 and 6) and send below command to calibrate the offset.

```
CAL:OUTP:OVERVOLT:EXTV:OFFS
```

- c) Apply 5.0 volts across rear panel DB26 connector pin OVPPRG_VOLT and return (pin 5 and 6) and send below command to calibrate the gain.

```
CAL:OUTP:OVERVOLT:EXTV:FSC
```

- d) Store the calibration by sending the below commands.

```
CAL:UNLOCK "6867"  
CAL:STORE  
CAL:LOCK.
```

10.2.5.6 CURRENT PROGRAMMING – 10V RANGE VOLTAGE SOURCE

- a) Configure the current programming mode to internal, reference source as voltage and FSC to 10V by send the following SCPI commands:

```
OUTP:STAT OFF  
SOUR:CURR:PROG INT  
SOUR:CURR:PROG:SOUR VOLT
```

```
SOUR:CURR:PROG:FSC 10
```

- b) Apply -10 volts across rear panel DB26 connector pin IPRG_VOLT and return (pin 3 and 6) and send the command below to calibrate the offset.

```
CAL:OUTP:CURR:EXTV:POINT1 -10
```

- c) Apply 10.0 volts across rear panel DB26 connector pin IPRG_VOLT and return (pin 3 and 6) and send the command below to calibrate the gain.

```
CAL:OUTP:CURR:EXTV:POINT2 10
```

- d) Store the calibration by sending the below commands.

```
CAL:UNLOCK "6867"  
CAL:STORE  
CAL:LOCK
```

10.2.5.7 CURRENT PROGRAMMING – 5V RANGE VOLTAGE SOURCE

- a) Configure the current programming mode to internal, reference source as voltage and FSC to 5V by send the following SCPI commands:

```
OUTP:STAT OFF  
SOUR:CURR:PROG INT  
SOUR:CURR:PROG:SOUR VOLT  
SOUR:CURR:PROG:FSC 10
```

- b) Apply -5 volts across rear panel DB26 connector pin IPRG_VOLT and return (pin 3 and 6) and send the command below to calibrate the offset.

```
CAL:OUTP:CURR:EXTV:POINT1 -10
```

- c) Apply 5.0 volts across rear panel DB26 connector pin IPRG_VOLT and return (pin 3 and 6) and send the command below to calibrate the gain.

```
CAL:OUTP:CURR:EXTV:POINT1 10
```

- d) Store the calibration by sending the below commands.

```
CAL:UNLOCK "6867"  
CAL:STORE  
CAL:LOCK
```

10.2.5.8 CURRENT PROGRAMMING – 10k CURRENT SOURCE CALIBRATION

- a) Configure the UUT mode of operation as source, current programming mode to internal, reference source as current and FSCR to 10K Ohms by send the following SCPI commands:

```
OUTP:STAT OFF  
SOUR:CURR:PROG:SOUR CURR  
SOUR:CURR:PROG INT
```

- b) Connect a zero-ohm resistor across rear panel DB26 connector pin IPRGM_CURR and return (pin 4 and 6) and send below command to calibrate the offset.

```
CAL:OUTP:CURR:EXTI:OFFS
```

- c) Connect a 5.0K ohms resistor across rear panel DB26 connector pin IPRGM_CURR and return (pin 4 and 6) and send below command to calibrate the gain.

```
CAL:OUTP:CURR:EXTI:FSC  
STAT:MOD:STATUS? //Check for no faults.
```

- d) Store the calibration by sending the below commands.

```
CAL:UNLOCK "6867"  
CAL:STORE  
CAL:LOCK
```

10.2.6 REMOTE MONITOR OUTPUTS CALIBRATION

Remote Monitor output signals can be calibrated with set of commands as described in below section. For detailed Pin description of the Remote Monitor Outputs and connection diagram, Refer Section 8.2.1.

10.2.6.1 VOLTAGE MONITOR (VMON) TESTS

- a) Set the voltage to 0, current to maximum and enable the output by send the following SCPI commands:

```
SOUR:VOLT:0
SOUR:CURR <MAX Value>
OUTP:STAT 1
CAL:INIT:VOLT:MON
```

- b) Measure the voltage across VMON (pin 7 and 9) using DMM and send below command to calibrate the offset.

```
CAL:OUTP:VOLT:MON:OFFS <data> ,
```

NOTE: where '<data>' is the measured output voltage from the DMM.

- c) Set the voltage to 80% of the Full-Scale Voltage by sending the command below;

```
SOUR:VOLT <80% Full Scale Voltage >
```

- d) Measure the voltage across VMON (pin 7 and 9) using DMM and send below command to calibrate the FSC.

```
CAL:OUTP:VOLT:MON:FSC <measured VMON voltage>
```

- e) Store the calibration by sending the below commands.

```
CAL:UNLOCK "6867"
CAL:STORE
CAL:LOCK
```

10.2.6.2 CURRENT MONITOR (IMON) TESTS

- a) Connect the DC bidirectional power supply (ITECH) as load to the output of the UUT and Current Shunt in series. Connect the DMM to the sense terminals of the Current Shunt.
- b) Configure the DC bidirectional power supply to voltage priority and set Positive current, Negative current and voltage as below:

- If the UUT is with Auto Ranging option, configure as
 - Set Current positive = FSC
 - Set Current negative = 0
 - Set Voltage = Maximum rated power / Current rating

- If the UUT is Fixed Ranging option, configure as
 - Set Current = FSC
 - Set Current negative = 0
 - Set Voltage = Full scale rated voltage
 - Configure the UUT programming type into Current and regulation settings into CC/CV.

- c) Set the load current to zero amps.

- d) Set the voltage to maximum, current to 0 and enable the output by send the following SCPI commands:

```
SOUR:VOLT <MAX Value>
SOUR:CURR 0
OUTP:STAT 1
CAL:INIT:CURR:MON
```

- e) Measure the voltage at IMON (pin 8 and 9) using DMM and send below command to calibrate the offset.

```
CAL:OUTP:VOLT:MON:OFFS <measured IMON voltage>
```

- f) Set the voltage to 80% of the Full-Scale Voltage by sending the command below;

```
SOUR:CURR <80% full scale current>
```

- g) Set the load current to 100% output current using step b.

- h) Measure the voltage at IMON using DMM and send below command to calibrate the FSC.

```
CAL:OUTP:CURR:MON:FSC <measured IMON voltage>
```

- i) Store the calibration by sending the below commands.

```
CAL:UNLOCK "6867"
CAL:STORE
CAL:LOCK
```

This page intentionally left blank