



California Instruments

**CSW Series
SCPI Programming Manual**

SCPI Programming Reference Manual

CSW series AC/DC Power Systems

About AMETEK

AMETEK Programmable Power, Inc., a Division of AMETEK, Inc., is a global leader in the design and manufacture of precision, programmable power supplies for R&D, test and measurement, process control, power bus simulation and power conditioning applications across diverse industrial segments. From bench top supplies to rack-mounted industrial power subsystems, AMETEK Programmable Power is the proud manufacturer of Elgar, Sorensen, California Instruments and Power Ten brand power supplies.

AMETEK, Inc. is a leading global manufacturer of electronic instruments and electromechanical devices with annualized sales of \$2.5 billion. The Company has over 11,000 colleagues working at more than 80 manufacturing facilities and more than 80 sales and service centers in the United States and around the world.

Trademarks

AMETEK is a registered trademark of AMETEK, Inc. California Instruments is a trademark owned by AMETEK, Inc. Other trademarks, registered trademarks, and product names are the property of their respective owners and are used herein for identification purposes only.

Notice of Copyright

CSW Series Programming Manual © 2020 AMETEK Programmable Power, Inc. All rights reserved.

Exclusion for Documentation

UNLESS SPECIFICALLY AGREED TO IN WRITING, AMETEK PROGRAMMABLE POWER, INC. ("AMETEK"):

- (a) MAKES NO WARRANTY AS TO THE ACCURACY, SUFFICIENCY OR SUITABILITY OF ANY TECHNICAL OR OTHER INFORMATION PROVIDED IN ITS MANUALS OR OTHER DOCUMENTATION.
- (b) ASSUMES NO RESPONSIBILITY OR LIABILITY FOR LOSSES, DAMAGES, COSTS OR EXPENSES, WHETHER SPECIAL, DIRECT, INDIRECT, CONSEQUENTIAL OR INCIDENTAL, WHICH MIGHT ARISE OUT OF THE USE OF SUCH INFORMATION. THE USE OF ANY SUCH INFORMATION WILL BE ENTIRELY AT THE USER'S RISK, AND
- (c) REMINDS YOU THAT IF THIS MANUAL IS IN ANY LANGUAGE OTHER THAN ENGLISH, ALTHOUGH STEPS HAVE BEEN TAKEN TO MAINTAIN THE ACCURACY OF THE TRANSLATION, THE ACCURACY CANNOT BE GUARANTEED. APPROVED AMETEK CONTENT IS CONTAINED WITH THE ENGLISH LANGUAGE VERSION, WHICH IS POSTED AT WWW.PROGRAMMABLEPOWER.COM.

Date and Revision

March 2020 Revision Rev E

Part Number

M162084-03

Contact Information

Telephone: 800 733 5427 (toll free in North America)
858 450 0085 (direct)



Fax: 858 458 0267

Email: sales.ppd@ametek.com
service.ppd@ametek.com

Web: www.powerandtest.com

Important Safety Instructions

Before applying power to the system, verify that your product is configured properly for your particular application.

 WARNING	<p>Hazardous voltages may be present when covers are removed. Qualified personnel must use extreme caution when servicing this equipment. Circuit boards, test points, and output voltages also may be floating above (below) chassis ground.</p>
 WARNING	<p>The equipment used contains ESD sensitive parts. When installing equipment, follow ESD Safety Procedures. Electrostatic discharges might cause damage to the equipment.</p>

Only *qualified personnel* who deal with attendant hazards in power supplies, are allowed to perform installation and servicing.

Ensure that the AC power line ground is connected properly to the Power Rack input connector or chassis. Similarly, other power ground lines including those to application and maintenance equipment *must* be grounded properly for both personnel and equipment safety.













Always ensure that facility AC input power is de-energized prior to connecting or disconnecting any cable.

In normal operation, the operator does not have access to hazardous voltages within the chassis. However, depending on the user's application configuration, **HIGH VOLTAGES HAZARDOUS TO HUMAN SAFETY** may be normally generated on the output terminals. The customer/user must ensure that the output power lines are labeled properly as to the safety hazards and that any inadvertent contact with hazardous voltages is eliminated.

Guard against risks of electrical shock during open cover checks by not touching any portion of the electrical circuits. Even when power is off, capacitors may retain an electrical charge. Use safety glasses during open cover checks to avoid personal injury by any sudden component failure.

Neither AMETEK Programmable Power Inc., San Diego, California, USA, nor any of the subsidiary sales organizations can accept any responsibility for personnel, material or inconsequential injury, loss or damage that results from improper use of the equipment and accessories.

SAFETY SYMBOLS

 WARNING Risk of Electrical Shock	 CAUTION Refer to Accompanying Documents
 Off (Supply)	 Direct Current (DC)
 Standby (Supply)	 Alternating Current (AC)
 On (Supply)	 Three-Phase Alternating Current
 Protective Conductor Terminal	 Earth (Ground) Terminal
 Fuse	 Chassis Ground

Product Family: CSW Series AC Power Source**Warranty Period: 1 Year****WARRANTY TERMS**

AMETEK Programmable Power, Inc. (“AMETEK”), provides this written warranty covering the Product stated above, and if the Buyer discovers and notifies AMETEK in writing of any defect in material or workmanship within the applicable warranty period stated above, then AMETEK may, at its option: repair or replace the Product; or issue a credit note for the defective Product; or provide the Buyer with replacement parts for the Product.

The Buyer will, at its expense, return the defective Product or parts thereof to AMETEK in accordance with the return procedure specified below. AMETEK will, at its expense, deliver the repaired or replaced Product or parts to the Buyer. Any warranty of AMETEK will not apply if the Buyer is in default under the Purchase Order Agreement or where the Product or any part thereof:

- is damaged by misuse, accident, negligence or failure to maintain the same as specified or required by AMETEK;
- is damaged by modifications, alterations or attachments thereto which are not authorized by AMETEK;
- is installed or operated contrary to the instructions of AMETEK;
- is opened, modified or disassembled in any way without AMETEK’s consent; or
- is used in combination with items, articles or materials not authorized by AMETEK.

The Buyer may not assert any claim that the Products are not in conformity with any warranty until the Buyer has made all payments to AMETEK provided for in the Purchase Order Agreement.

PRODUCT RETURN PROCEDURE

Request a Return Material Authorization (RMA) number from the repair facility (**must be done in the country in which it was purchased**):

- **In the USA**, contact the AMETEK Repair Department prior to the return of the product to AMETEK for repair:
Telephone: 800-733-5427, ext. 2295 or ext. 2463 (toll free North America)
858-450-0085, ext. 2295 or ext. 2463 (direct)
- **Outside the United States**, contact the nearest Authorized Service Center (ASC). A full listing can be found either through your local distributor or our website, www.powerandtest.com, by clicking Support and going to the Service Centers tab.

When requesting an RMA, have the following information ready:

- Model number
- Serial number
- Description of the problem

NOTE: Unauthorized returns will not be accepted and will be returned at the shipper’s expense.

NOTE: A returned product found upon inspection by AMETEK, to be in specification is subject to an evaluation fee and applicable freight charges.

Table of Contents

1.	Introduction	10
1.1	Documentation Summary.....	10
1.2	External References.....	10
1.3	Introduction to Programming.....	11
2.	Introduction to SCPI.....	13
2.1	Conventions Used in This Manual	13
2.2	The SCPI Commands and Messages.....	13
2.3	Using Queries.....	16
2.4	Structure of a SCPI Message.....	16
2.5	SCPI Data Formats	20
3.	System Considerations and Interface Setup	21
3.1	Assigning the IEEE-488 Address	21
3.2	GPIB Controllers	21
3.3	RS232C Interface	23
3.4	USB Interface	25
3.5	LAN Interface Option.....	34
4.	SCPI Command Reference	37
4.1	Introduction.....	37
4.2	Calibration Subsystem	38
4.3	Display Subsystem.....	46
4.4	Instrument Subsystem	48
4.5	Array Measurement Subsystem.....	50
4.6	Current Measurement Subsystem	57
4.7	Frequency Measurement Subsystem	61
4.8	Phase Measurement Subsystem	62
4.9	Power Measurement Subsystem	63
4.10	Voltage Measurement Subsystem	65
4.11	Output Subsystem.....	68
4.12	Source Subsystem - Current.....	73
4.13	Source Subsystem - Frequency.....	75
4.14	Source Subsystem - Function	78
4.15	Source Subsystem - Limit	80
4.16	Sense Subsystem - Sweep.....	82
4.17	Source Subsystem - List	84
4.18	Source Subsystem - Mode.....	92
4.19	Source Subsystem - Phase.....	93
4.20	Source Subsystem - PONSetup.....	94
4.21	Source Subsystem - Pulse.....	98
4.22	Source Subsystem - Voltage.....	101
4.23	Status Subsystem Commands.....	106
4.24	System Commands.....	110
4.25	Trace Subsystem Commands.....	116
4.26	Trigger Subsystem	118
5.	Common Commands.....	123
5.1	*CLS	124
5.2	*ESE.....	125
5.3	*ESR?.....	125
5.4	*IDN?.....	126
5.5	*OPC	126
5.6	*OPT?.....	127

5.7	*PSC	129
5.8	*RCL.....	129
5.9	*RST.....	130
5.10	*SAV.....	131
5.11	*SRE	131
5.12	*STB?.....	132
5.13	*TRG	133
5.14	*WAI.....	133
6.	Programming Examples	134
6.1	Introduction	134
6.2	Programming the Output.....	135
6.3	Coupled Commands	140
6.4	Programming Output Transients.....	141
6.5	Triggering Output Changes.....	146
6.6	Acquiring Measurement Data	149
6.7	Controlling the Instantaneous Voltage and Current Data Buffers.....	155
6.8	Trigger System Summary	157
7.	Status Registers	158
7.1	Power-On Conditions	158
7.2	Operation Status Group.....	158
7.3	Questionable Status Group.....	161
7.4	Standard Event Status Group	162
7.5	Status Byte Register	162
7.6	Examples	163
7.7	SCPI Command Completion.....	164
8.	Option Commands.....	165
8.1	Introduction	165
8.2	IEC 1000-4-11 (-411).....	166
8.3	IEC 1000-4-13 (-413).....	170
8.4	RTCA/DO-160D (-160)	183
8.5	MIL-STD 704E (-704).....	184
8.6	Airbus ABD0100.1.8 Test Option (-ABD).....	184
8.7	Airbus A350 ABD0100.1.8.1 Test Option (-A350)	184
8.8	Airbus AMD24 Test Option (-AMD).....	184
8.9	Boeing B787-0147 Test Option (-B787)	184
8.10	Watt Hour Meter (-WHM).....	184
	Appendix A: SCPI Command tree	186
	Appendix B: SCPI Conformance Information.....	192
	Appendix C: Error Messages	193
	Index.....	199

Table of Figures

Figure 2-1 : Partial Command Tree	14
Figure 2-2: Command Message Structure.....	17
Figure 3-1: DB25 to DB9 Adaptor pinout	24
Figure 3-2: Windows XP Device Manager - USB Port.....	28
Figure 3-3: Windows XP Device Manager – Virtual Com Port.....	32
Figure 3-4: Gui Interface Settings for use of USB port.	33
Figure 3-5: Pinging AC Source LAN IP address.	36
Figure 6-1: Output transient system	142
Figure 6-2: Transient Trigger System Model	146
Figure 6-3: Measurement Acquisition Trigger Model	153
Figure 6-4: Pre-event and Post-event Triggering.....	156
Figure 6-5: Trigger system block diagram	157
Figure 7-1: Status System Model	159

Table of Tables

Table 4-1 : PULSe:HOLD = WIDTH parameters.....	99
Table 4-2 : PULSe:HOLD = DCYClE parameters	99
Table 5-1 : *RST default parameter values	130
Table 7-1: Operation Status Register	158
Table 7-2: Configuration of Status Register.....	160
Table 7-3: Questionable Status Register	161
Table 8-4 : Error Messages	198

1. Introduction

This manual contains programming information for the CSW Power Sources. This manual contains the following chapters:

Chapter 1	Introduction
Chapter 2	Introduction to SCPI
Chapter 3	System Considerations and Interface Setup
Chapter 4	SCPI Command Reference
Chapter 5	Common Commands
Chapter 6	Programming Examples
Chapter 7	Status Registers
Chapter 8	Option Commands
Appendix A	SCPI command tree.
Appendix B	SCPI conformance information.
Appendix C	Error messages

1.1 Documentation Summary

This SCPI programming manual covers the California Instruments CSW AC/DC power sources. A separate User Manual is also supplied with all models in this product series. For front panel operation and general service and calibration information on these products, please refer to the User Manual. The programming manual covers issue related to operating the CSW Series remotely using an instrument controller.

The following documents are related to this Programming Manual and contain additional helpful information for using these products in a remote control environment.

- User Manual . Includes specifications and supplemental characteristics, how to use the front panel, how to connect to the instrument, and calibration procedures. Distributed on the same CD as the programming manual.

1.2 External References

SCPI References

The following documents will assist you with programming in SCPI:

- Beginner's Guide to SCPI.

Highly recommended for anyone who has not had previous experience programming with SCPI.

IEEE-488 References

The most important IEEE-488 documents are your controller programming manuals -IEEE-488 Command Library for Windows®, etc. Refer to these for all non-SCPI commands (for example: Local Device Clear and Group Execute Trigger bus commands.)

- IEEE-488 command library for Windows®.
- IEEE-488 controller programming

The following are two formal documents concerning the IEEE-488 interface:

- ANSI/IEEE Std. 488.1-1987 IEEE Standard Digital Interface for Programmable Instrumentation. Defines the technical details of the IEEE-488 interface. While much of

the information is beyond the need of most programmers, it can serve to clarify terms used in this guide and in related documents.

- ANSI/IEEE Std. 488.2-1987 IEEE Standard Codes, Formats, Protocols, and Common Commands. Recommended as a reference only if you intend to do fairly sophisticated programming. Helpful for finding precise definitions of certain types of SCPI message formats, data types, or common commands.

The above two documents are available from the IEEE (Institute of Electrical and Electronics Engineers), 345 East 47th Street, New York, NY 10017, USA.

1.3 Introduction to Programming

This section provides some general information regarding programming instrumentation and available interface types.

1.3.1 IEEE-488 Capabilities of the AC/DC Source

All AC/DC source functions are programmable over the IEEE-488 or RS232C interface bus. Newer models also offer USB and Ethernet (LAN). The IEEE 488.2 capabilities of the AC/DC source are listed in appendix A of the User's Guide.

IEEE-488 Address

The AC/DC source operates from a single IEEE-488 address that may be set from the front panel or programmatically through the IEEE-488 bus. To set the IEEE-488 address from the front panel, select the Utility entry from the menu screen. Care must be used when setting the IEEE-488 address programmatically since the next statement sent to the source must reflect the new address.

1.3.2 USB Capabilities of the AC source

All AC source functions are programmable over the USB interface. The USB capabilities of the AC source are listed in Chapter 2 of the User's Manual. Some capabilities support on the GPIB interface such as ATN, GET and SRQ interrupts do not apply to the USB interface. The USB interface operates internally at a fixed baudrate of 460800 baud but USB 2.0 burst transfer rates are supported.

To set up the USB interface on a Windows XP PC, refer to section 3.4, "USB Interface".

The USB interface may be used to install updated firmware for the controller if needed. Firmware updates and a Flash Loader utility program and instructions are available from the AMETEK Programmable Power website for this purpose. (www.programmablepower.com)

Multiple USB connections to same PC:

The Windows driver used to interface to the power source's USB port emulates a serial com port. This virtual com port driver is unable to reliably differentiate between multiple units however so the use of more than one AC power source connected to the same PC via USB is not recommended. Use of the GPIB interface is recommended for these situations.

1.3.3 LAN Capabilities of the AC source

All AC source functions are programmable over the LAN (Ethernet) interface if the –LAN option is installed. The LAN capabilities of the AC source are listed in Chapter 2 of the User's Manual. Some capabilities support on the GPIB interface such as ATN, GET and SRQ interrupts do not apply to the LAN interface. The LAN interface operates internally at a fixed baudrate of 460800 baud but autodetection of 10Base-T, 100Base-T and 1000Base-T is supported.

To set up the LAN interface on a Windows XP PC, refer to section 3.5, “LAN Interface Option”.

1.3.4 **RS232C Capabilities of the AC source**

All AC source functions are programmable over the RS232C interface. The RS232C capabilities of the AC source are listed in Chapter 2 of the User's Manual. Some capabilities support on the GPIB interface such as ATN, GET and SRQ interrupts do not apply to the RS232C interface. Baudrates from 9600 to 115200 are supported on units that have both USB and RS232. For units with only RS232, the maximum baudrate is 38400.

To set up the RS232C interface, refer to section 3.3, “RS232C Interface”.

The RS232C interface may be used to install updated firmware for the controller if needed. Firmware updates and a Flash Loader utility program and instructions are available from the AMETEK Programmable Power website for this purpose. (www.programmablepower.com)

2. Introduction to SCPI

SCPI (Standard Commands for Programmable Instruments) is a programming language for controlling instrument functions over the IEEE-488. SCPI is layered on top of the hardware-portion of IEEE 488.1. The same SCPI commands and parameters control the same functions in different classes of instruments. For example, you would use the same MEAS:VOLT? command to measure the AC/DC source output voltage or the output voltage measured using a SCPI-compatible multimeter.

2.1 Conventions Used in This Manual

Angle brackets<>	Items within angle brackets are parameter abbreviations. For example, <NR1> indicates a specific form of numerical data.
Vertical bar	Vertical bars separate alternative parameters. For example, FIX STEP indicates that either "FIX" or "STEP" can be used as a parameter.
Square Brackets []	Items within square brackets are optional. The representation [SOURce:]LIST means that SOURce: may be omitted.
Braces	Braces indicate parameters that may be repeated zero or more times. It is used especially for showing arrays. The notation <A> <,B> shows that parameter "A" must be entered, while parameter "B" may be omitted or may be entered one or more times.
Boldface font	Boldface font is used to emphasize syntax in command definitions. TRIGger:SOURCe<NRf> shows a command definition.
Computer font	Computer font is used to show program lines in text. TRIGger:SOURCe INT shows a program line.

2.2 The SCPI Commands and Messages

This paragraph explains the syntax difference between SCPI Commands and SCPI messages.

2.2.1 Types of SCPI Commands

SCPI has two types of commands, common and subsystem.

- Common commands are generally not related to specific operations but to controlling overall AC source functions such as reset, status and synchronization. All common commands consist of a three-letter mnemonic preceded by an asterisk:
 - *RST
 - *IDN?
 - *SRE 256
- Subsystem commands perform specific AC/DC source functions. They are organized into an inverted tree structure with the "root" at the top. Some are single commands while others are grouped within specific subsystems.

Refer to appendix A for the AC source SCPI tree structure.

2.2.2 Types of SCPI Messages

There are two types of SCPI messages, program and response.

- A program message consists of one or more properly formatted SCPI commands sent from the controller to the AC/DC source. The message, which may be sent at any time, requests the AC/DC source to perform some action.
- A response message consists of data in a specific SCPI format sent from the AC source to the controller. The AC source sends the message only when commanded by a program message called a "query."

2.2.3 The SCPI Command Tree

As previously explained, the basic SCPI communication method involves sending one or more properly formatted commands from the SCPI command tree to the instrument as program messages. The following figure shows a portion of a subsystem command tree, from which you access the commands located along the various paths (you can see the complete tree in appendix A).

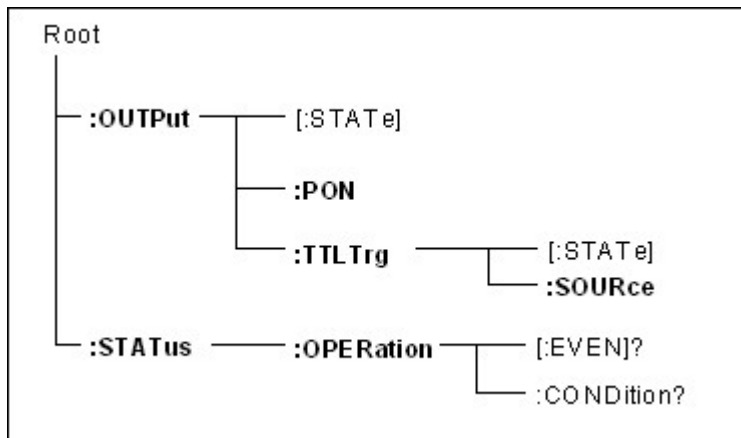

Figure 2-1 : Partial Command Tree

The Root Level

Note the location of the ROOT node at the top of the tree. Commands at the root level are at the top level of the command tree. The SCPI interface is at this location when:

- The AC/DC source is powered on
- A device clear (DCL) is sent to the AC source
- The SCPI interface encounters a message terminator
- The SCPI interface encounters a root specifier

Active Header Path

In order to properly traverse the command tree, you must understand the concept of the active header path. When the AC/DC source is turned on (or under any of the other conditions listed above), the active path is at the root. That means the SCPI interface is ready to accept any command at the root level, such as SOURCe or MEASurement

If you enter SOURCe the active header path moves one colon to the right. The interface is now ready to accept :VOLTage :FREQuency, or :CURRent as the next header. You must include the colon, because it is required between headers.

If you now enter :VOLTage, the active path again moves one colon to the right. The interface is now ready to accept either :RANGe or :LEVel as the next header.

If you now enter :RANGe you have reached the end of the command string. The active header path remains at :RANGe. If you wished, you could have entered :RANGe 135 ;LEVel 115 and it would be accepted as a compound message consisting of:

```
SOURce:VOLTage:RANGe 156.
```

```
SOURce:VOLTage:LEVel 115.
```

The entire message would be:

```
SOURce:VOLTage:RANGe 156;LEVel 115
```

The message terminator after LEVel 115 returns the path to the root.

The Effect of Optional Headers

If a command includes optional headers, the interface assumes they are there. For example, if you enter [SOURce]:VOLTage 115, the interface recognizes it as [SOURce]:VOLTage:LEVel 115. This returns the active path to the root (:VOLTage). But if you enter [SOURce]:VOLTage:LEVel 115 then the active path remains at :LEVel. This allows you to send

```
[SOURce]:VOLTage:LEVel 115;RANGe 156
```

in one message. If you did not send LEVel you are allowed to send the following command:

```
[SOURce]:VOLTage 115;FREQuency 60
```

The optional header [SOURce] precedes the current, frequency, function, phase, pulse, list, and voltage subsystems. This effectively makes :CURRent, :FREQuency, :FUNctIon, :PHASe, :PULSe, :LIST, and :VOLTage root-level commands.

Moving Among Subsystems

In order to combine commands from different subsystems, you need to be able to restore the active path to the root. You do this with the root specifier (:). For example, you could open the output relay and check the status of the Operation Condition register as follows:

```
OUTPut:STATe ON
```

```
STATus:OPERation:CONDition?
```

Because the root specifier resets the command parser to the root, you can use the root specifier and do the same thing in one message:

```
OUTPut on; :STATus:OPERation:CONDition?
```

The following message shows how to combine commands from different subsystems as well as within the same subsystem:

```
VOLTage:RANGe 156;LEVel 115;:CURRent 10;PROTection:STATe ON
```

Note the use of the optional header LEVel to maintain the correct path within the voltage and current subsystems and the use of the root specifier to move between subsystems. The "Enhanced Tree Walking Implementation" given in appendix A of the IEEE 488.2 standard is not implemented in the AC/DC source.

Including Common Commands

You can combine common commands with system commands in the same message. Treat the common command as a message unit by separating it with a semicolon (the message unit separator). Common commands do not affect the active header path; you may insert them anywhere in the message.

```
VOLTage:TRIGger 7.5;*TRG
OUTPut OFF;OUTPut ON;*RCL 2
```

2.3 Using Queries

Observe the following precautions with queries:

- Set up the proper number of variables for the returned data.
- Read back all the results of a query before sending another command to the AC source. Otherwise a Query Interrupted error will occur and the unreturned data will be lost.

2.4 Structure of a SCPI Message

SCPI messages consist of one or more message units ending in a message terminator. The terminator is not part of the syntax, but implicit in the way your programming language indicates the end of a line (such as a newline or end-of-line character).

2.4.1 The Message Unit

The simplest SCPI command is a single message unit consisting of a command header (or keyword) followed by a message terminator.

```
FREQuency?<newline>
VOLTage?<newline>
```

The message unit may include a parameter after the header. The parameter usually is numeric, but it can be a string:

```
VOLTage 20<newline>
VOLTage MAX<newline>
```

2.4.2 Combining Message Units

The following command message is briefly described here, with details in subsequent paragraphs.

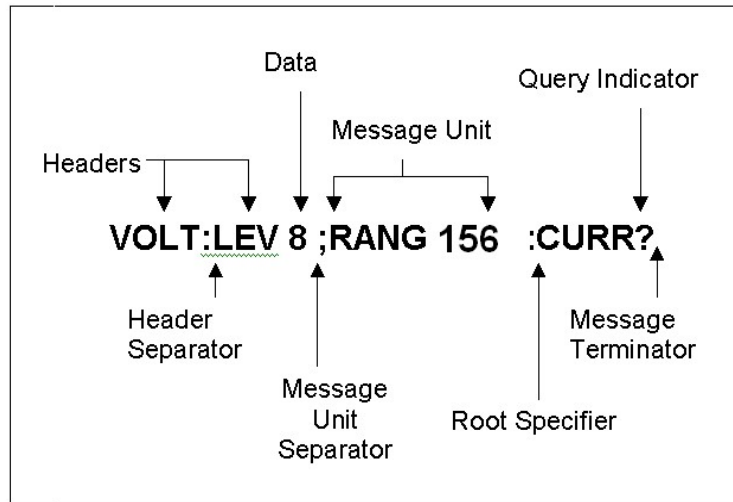

Figure 2-2: Command Message Structure

The basic parts of the above message are:

<u>Message Component</u>	<u>Example</u>
Headers	VOLT LEV RANG CURR
Header Separator	The colon in VOLT:LEV
Data	8 156
Data Separator	The space in VOLT 8 and RANG 156
Message Units	VOLT:LEV 8 RANG 156 CURR?
Message Unit Separator	The semicolons in VOLT:LEV 8; and RANG 156;
Root Specifier	The colon in RANG 156;:CURR?
Query Indicator	The question mark in CURR?
Message Terminator	The <NL> (newline) indicator. Terminators are not part of the SCPI syntax

2.4.3 Headers

Headers are instructions recognized by the AC/DC source. Headers (which are sometimes known as "keywords") may be either in the long form or the short form.

Long Form	The header is completely spelled out, such as VOLTAGE, STATUS, and OUTPUT.
Short Form	The header has only the first three or four letters, such as VOLT, STAT, and OUTP.

The SCPI interface is not sensitive to case. It will recognize any case mixture, such as TRIGGER, Trigger, TRIGger. Short form headers result in faster program execution.

Header Convention

In the command descriptions in Chapter 3.4 of this manual, headers are emphasized with boldface type. The proper short form is shown in upper-case letters, such as DELay.

Header Separator

If a command has more than one header, you must separate them with a colon (VOLT:LEVel
OUTPut:RELAy ON).

Optional Headers

The use of some headers is optional. Optional headers are shown in brackets, such as OUTPut[:STATe] ON. As previously explained under "The Effect of Optional Headers", if you combine two or more message units into a compound message, you may need to enter the optional header.

2.4.4 Query Indicator

Following a header with a question mark turns it into a query (VOLTage?, VOLTage:RANGe?). If a query contains a parameter, place the query indicator at the end of the last header (VOLTage:LEVel? MAX).

2.4.5 Message Unit Separator

When two or more message units are combined into a compound message, separate the units with a semicolon (STATus:OPERation?;QUESTionable?).

2.4.6 Root Specifier

When it precedes the first header of a message unit, the colon becomes the root specifier. It tells the command parser that this is the root or the top node of the command tree. Note the difference between root specifiers and header separators in the following examples:

<code>CURRent:PROTection:DELaY .1</code>	All colons are header separators
<code>:CURRent:PROTection:DELaY .1</code>	Only the first colon is a root specifier
<code>CURRent:PROTection:DELaY .1;:VOLTagE 12.5</code>	Only the third colon is a root specifier

You do not have to precede root-level commands with a colon; there is an implied colon in front of every root-level command.

2.4.7 Message Terminator

A terminator informs SCPI that it has reached the end of a message. Three permitted message terminators are:

- newline (<NL>), which is ASCII decimal 10 or hex 0A.
- end or identify (<END>)
- both of the above (<NL><END>).

In the examples of this manual, there is an assumed message terminator at the end of each message. If the terminator needs to be shown, it is indicated as <NL> regardless of the actual terminator character.

2.5 SCPI Data Formats

All data programmed to or returned from the AC source is in ASCII. The data type may be numerical or character string.

2.5.1 Numerical Data Formats

<u>Symbol</u>	<u>Data Form</u>
Talking Formats	
<NR1>	Digits with an implied decimal point assumed at the right of the least-significant digit. Example: 273
<NR2>	Digits with an explicit decimal point. Example:.0273
<NR3>	Digits with an explicit decimal point and an exponent. Example: 2.73E+2
<Bool>	Boolean Data. Example: 0 1 or ON OFF
Listening Formats	
<Nrf>	Extended format that includes <NR1>, <NR2> and <NR3>. Examples: 273 273.0 2.73E2
<Nrf+>	Expanded decimal format that includes <Nrf> and MIN, MAX. Examples: 273, 273.0, 2.73E2, MAX. MIN and MAX are the minimum and maximum limit values that are implicit in the range specification for the parameter.
<Bool>	Boolean Data Example: 0 1

2.5.2 Character Data

Character strings returned by query statements may take either of the following forms, depending on the length of the returned string:

<CRD>	Character Response Data. Permits the return of character strings.
<AARD>	Arbitrary ASCII Response Data. Permits the return of undelimited 7-bit ASCII. This data type has an implied message terminator.
<SRD>	String Response Data. Returns string parameters enclosed in double quotes.

3. System Considerations and Interface Setup

This chapter addresses some system issues concerning programming. These are AC/DC Source addressing and the use of the following IEEE-488 system interface controllers:

- National Instruments PCI-GPIB controller with the Windows® gpib-32.dll driver.
- Agilent 82350 PCI GPIB Controller using the SICL driver library.

3.1 Assigning the IEEE-488 Address

The AC/DC source address can be set remotely or locally. All CSW Series AC/DC source are shipped with the IEEE-488 address set to 1 from the factory. Once the address is set, you can assign it inside programs. Note that some PC IEEE-488 controller interface cards may require you to run a setup utility to assign the AC/DC source address. In most cases however, the instrument address can be set from the application program.

For systems using the National Instruments driver, the address of the IEEE-488 controller is specified in the software configuration program located in the Windows 95® control panel. This is not the instrument address. The controller often uses 0 as its own address so the use of 0 as an instrument address should be avoided. The AC/DC source address can be assigned dynamically in the application program. (see the National Instruments GP-IB documentation supplied with the controller card).

3.2 GPIB Controllers

The HP 82350 and National Instruments PCI-GPIB are two popular GPIB controllers for the PC platform. Each is briefly described here. See the software documentation supplied with the controller card for more details.

3.2.1 Agilent 82350 Driver

The Agilent 82350 supports either the VISA or SICL instrument driver I/O library which provides software compatibility across all Agilent GPIB controllers. We recommend you use this driver to develop your code.

3.2.2 National Instruments GP-IB Driver

Your program must include the National Instruments header file for C programs or the VBIB.BAS and VBIB-32.BAS modules for Visual Basic. If you are using LabView™ or LabWindows™, make sure to select the correct controller when installing the IDE program. Prior to running any applications programs, you must set up the GPIB controller hardware with the configuration program located in the Windows Control Panel. For plug and play versions of the AT/GPIB-TNT, the setup will be performed when the card is first detected.

Regardless of the GPIB interface controller used, the power supply expects a message termination on EOI or line feed, so set EOI w/last byte of Write. It is also recommended that you set Disable Auto Serial Polling.

All function calls return the status word IBSTA%, which contains a bit (ERR) that is set if the call results in an error. When ERR is set, an appropriate code is placed in variable IBERR%. Be sure to check IBSTA% after every function call. If it is not equal to zero, branch to an error handler that reads IBERR% to extract the specific error.

Error Handling

If there is no error-handling code in your program, undetected errors can cause unpredictable results. This includes "hanging up" the controller and forcing you to reset the system. Both of the above libraries have routines for detecting program execution errors.

Important: Use error detection throughout your application program.

3.3 RS232C Interface

CSW power sources that have an RS232 interface but no USB interface use a special cable to connect to a 9 pin PC serial port. The cable is marked "SOURCE" on one end and "PC" on the other end and the orientation of the cable is important. The required serial cable is supplied with the source. If you are unable to locate this cable, you need to use a cable that conforms to the wiring diagram shown in **Error! Reference source not found.**

CSW power source that have both RS232 and USB interface use a standard straight through DB9 to DB9 serial cable. The orientation of the cable is not important. This cable (CI P/N 250709) is also supplied with the power source.

Note: *If a USB cable is plugged into the USB interface connector of the power source, the RS232 interface will be disabled. Remove any USB connection to use the RS232 port.*

3.3.1 Serial Communication Test Program

The following sample program written in GW-BASIC can be used to check communication to the CSW Series source over the RS232C serial interface.

```
'California Instruments CSW Series RS232C Communication Demo Program
'(c) 1995-2002 Copyright California Instruments, All Rights Reserved
'This program is for demonstration purposes only and is not to be
'used for any commercial application
'=====
'OPEN COM2. Replace with COM1, COM3 or COM4 for Com port used
'The input and output buffers are set to 2K each although
'this is not required for most operations.
OPEN "COM2:9600,n,8,1,BIN,TB2048,RB2048" FOR RANDOM AS #1
CLS
PRINT "**** INTERACTIVE MODE ****"
'Enter and endless loop to accept user entered commands
DO
    INPUT "Enter AC Source Command ('quit' to exit)--> ", cmd$
    IF cmd$ <> "QUIT" AND cmd$ <> "quit" THEN
        PRINT #1, cmd$ + CHR$(10);
        IF INSTR(cmd$, "?") THEN
            PRINT #1, CHR$(4);
            LINE INPUT #1, response$
            PRINT response$
        END IF
        'Check for Errors after each command is issued
        PRINT #1, "*ESR?" + CHR$(10);
        PRINT #1, CHR$(4);
        LINE INPUT #1, esr$
        esr% = VAL(esr$) AND 60
        IF esr% AND 4 THEN
            PRINT "**** Query Error Reported by AC Source ****"
        END IF
        IF esr% AND 8 THEN
            PRINT "**** Instrument Dependent Error Reported by AC Source ****"
        END IF
        IF esr% AND 16 THEN
            PRINT "**** Command Execution Error Reported by AC Source ****"
        END IF
        IF esr% AND 32 THEN
            PRINT "**** Command Syntax Error Reported by AC Source ****"
        END IF
    END IF
LOOP UNTIL cmd$ = "QUIT" OR cmd$ = "quit"
'Close COM port on exit
CLOSE #1
END
```

3.3.2 Serial Cable Diagram

All CSW units without LAN have a RS232 interface. The RS232 cable must be of the "Null Modem" type, straight through. Refer to the CSW User Manual, M162084-01, for additional cable information.

If the controller or PC only has a 25 pin D sub COM port, a 25 to 9 pin adaptor is required to use the serial cable supplied with the CSW. These small triangular shape adaptors can be purchased at most computer stores or outlets like Radio Shack. If none can be found, one can be constructed using the diagram shown below.

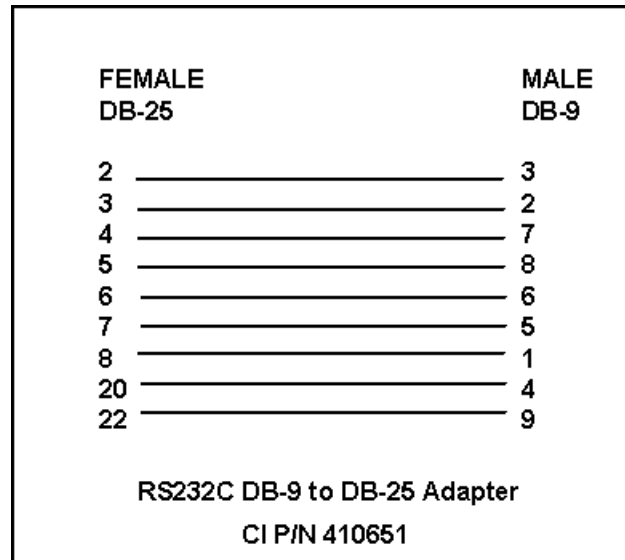

Figure 3-1: DB25 to DB9 Adaptor pinout

3.4 USB Interface

A standard USB Series B device connector is located on the rear panel for remote control. A standard USB cable between the AC Source and a PC or USB Hub may be used. Refer to user manual M162084-01 for connector pin out information.

Unlike RS232, there are no generic drivers available as a rule for use in programming environments such as LabView, LabWindows/CVI or Visual Basic. However, support for USB is included under VISA and may be used to interface to the power source using the USB interface.

A virtual serial port utility is provided on CD ROM CIC496, which ships with the power source. This utility will provide a virtual COM port on a PC under Windows XP. This allows programs to use the USB port as though it is a regular serial port on the PC. The baud rate for this mode of operation is fixed at 460,800. The USB-Serial Adaptor installation must be run to install the virtual com port driver. This option is only supported under Windows XP at this time.

Note: *Use of the USB port to control more than one power source from a single PC is not recommended, as communication may not be reliable. Use GPIB interface for multiple power source control.*

3.4.1 USB Driver Installation

When connecting the AC source through the USB interface to Windows XP PC, the presence of a new USB device will be detected. Windows will display a dialog after a short delay prompting the user to install the USB device drivers. There are two steps to this process.

The first one installs the USB device itself. The second step allows installation of the USB to COM virtual port driver. This driver will allow access to the AC source USB interface using a virtual COM port. Many programming environments support RS232 access but not USB. The USB-to-COM virtual port driver is distributed on the CIC496 CD ROM.

Step 1: USB Device Driver installation



When the “Found New Hardware Wizard” dialog appears, select the “No, not this time.” option. The drivers are not available on line. Click on Next button to continue.

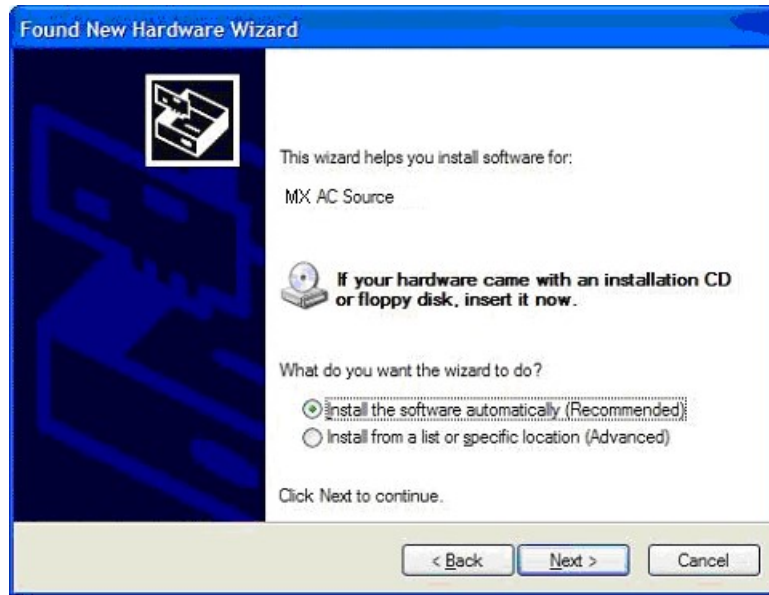

The next dialog will ask you to install the software for the CSW AC Source. Select the “Install the software automatically (Recommended)” option and click on Next to continue. If you are prompted for a file path, browse to the CD root drive and then USB_Inf (eg. D:\USB_Inf).



The USB device drivers have not been Windows XP Logo certified. Due to the limited distribution of these drivers, this is unlikely to be done. This Logo certification has no bearing on the functionality or legitimacy of this device driver so you can ignore this message. Click the “Continue Anyway” button to continue. Note that some PCs may have this verification disabled in which case this screen will not pop up.

The installation will now proceed. This process may take several minutes to complete.



Once completed, the dialog box shown above will appear signaling the device drivers have been installed. The USB interface is now available to the PC's operating system. To complete the install process, click on the "Finish" button.

To verify the USB port is available, you can access the Windows System Properties screen, select the Hardware tab and open the Windows Device Manager screen. The CSW Source should be listed under "Multi-port serial adapters" as shown in the image below.

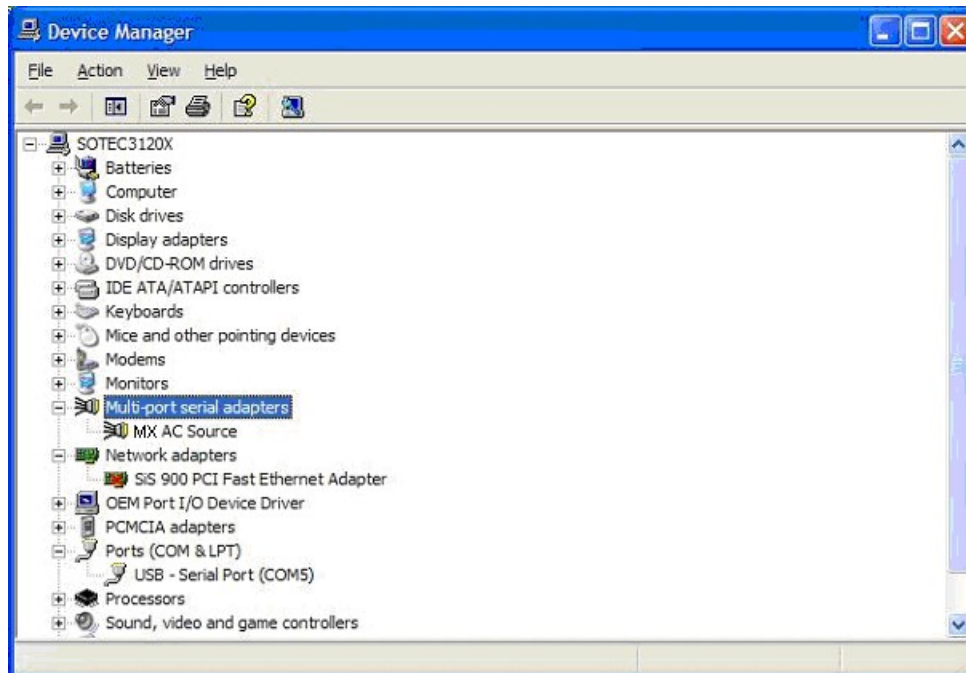

Figure 3-2: Windows XP Device Manager - USB Port

Step 2: USB to Com Virtual Device Driver installation

The second step allows installation of the USB to COM virtual port driver. This driver will allow access to the AC source USB interface using a virtual COM port. Many programming environments support RS232 access but not USB. The use of this driver will allow you to program the power source through the USB port as though it was an RS232 port. The USB-to-COM virtual port driver is distributed on the CIC496 CD ROM. This step is required to use the included Gui Windows software or other application software through USB.

To continue the installation, make sure the CIC496 CD Rom is available. Insert in the CD ROM drive if needed. If the auto-run screen appears, you can close it.



When the “Found New Hardware Wizard” dialog appears, select the “No, not this time.” option. The drivers are not available on line. Click on Next button to continue.



The next dialog will ask you to install the software for the CSW AC Source. Select the “Install the software automatically (Recommended)” option and click on Next to continue. If you are prompted for a file path, browse to the CD root drive and then USB_Inf (eg. D:\USB_Inf).



The USB device drivers have not been Windows XP Logo certified. Due to the limited distribution of these drivers, this is unlikely to be done. This Logo certification has no bearing on the functionality or legitimacy of this device driver so you can ignore this message. Click the “Continue Anyway” button to continue. Note that some PCs may have this verification disabled in which case this screen will not pop up.

The installation will now proceed. This process may take several minutes to complete. Once completed, the final dialog will appear as shown.



The USB to Com virtual port is now available to the PC's operating system. To complete the install process, click on the "Finish" button. To verify the virtual com port is available, you can access the Windows System Properties screen, select the Hardware tab and open the Windows Device Manager screen. The USB redirector should be listed under "Ports (COM & LPT)" as shown in the image below. The com port number is automatically assigned. Note the com port number for subsequent reference in your application software or when selected the COM port in the Gui Interface screen. This port number may be changed by opening the USB redirector properties and clicking on Port Settings, then Advanced, and selecting which port to use from the COM Port number drop down box.

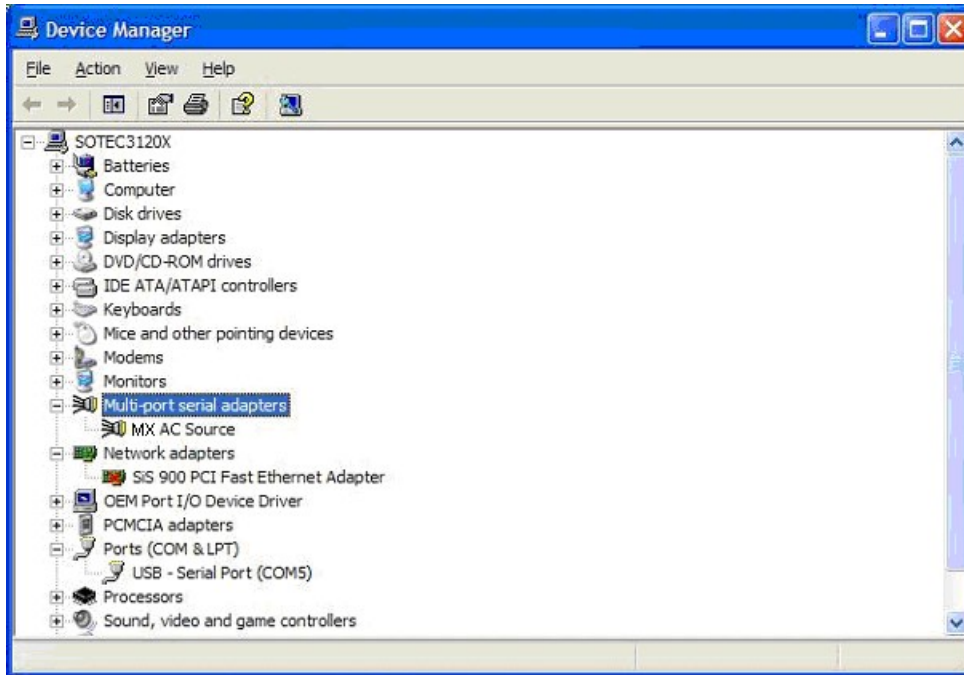

Figure 3-3: Windows XP Device Manager – Virtual Com Port

Once completed, you can remove the CIC496 CD Rom. The USB interface to the AC source is now available for use.

3.4.2 USB Interface Use

Note that the power source will be detected automatically when turn on or plugged in once the drivers have been installed. It is recommended however to close any open USB connections to the AC source before turning it off.

To use the USB interface, you may use the Gui Windows software supplied with the power source or develop your own application code. In either case, set the baud rate on the power source to 460,800 in the Configuration menu. From the Front panel, press MENU key, scroll to CONFIGURATION and press ENTER key. Select BAUDRATE field and scroll to 460800.

For use with the Gui program, select the “USB / RS232C Serial” interface type and set the Baud rate to 460800.

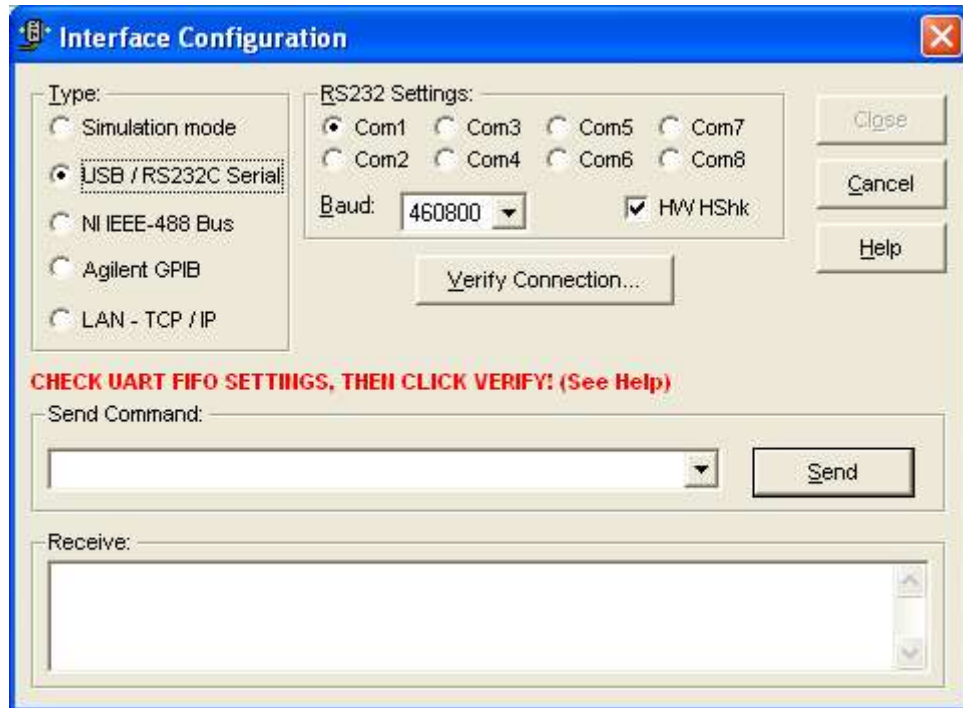

Figure 3-4: Gui Interface Settings for use of USB port.

Note: Use of the USB port to control more than one power source from a single PC is not recommended, as communication may not be reliable. Use GPIB interface for multiple power source control.

3.5 LAN Interface Option

An Ethernet LAN interface option is available as an option for the CSW Series power sources. This option must be specified at the time of order. A –LAN option indicator will appear on the model number tag at the rear-panel of the power source to indicate the presence of this option. Also, a RJ45 socket will be present on the rear panel.

Using LAN lets you communicate with the instrument remotely, it is fast, simple and the LAN from your PC does not require any additional proprietary software or cards.

Note: *If a USB cable is plugged into the USB interface connector of the power source, the LAN interface will be disabled. Remove any USB connection to use the LAN / Ethernet port.*

An RJ45 Ethernet 10BaseT connector is located on the rear panel if the –LAN option is installed. A standard RJ45 UTP patch cord between the AC Source and a network Hub may be used to connect the AC source to a LAN. For direct connection to a PC LAN card, a crossover RJ45 cable is required. Consult your network administrator for directions on connecting the AC source to any corporate LAN.

If the –LAN Ethernet interface option is present, the MAC Address (Media Access Control) of the Ethernet port is printed on the serial tag of the power source. The serial tag is located on the rear panel of the unit.

3.5.1 MAC Address

Each power source with the –LAN option installed has a unique network address (MAC address). The MAC address (Media Access Control) is a unique hexadecimal address and is listed on a label on the rear panel of the power source. To operate the power source on a network, this MAC address needs to be assigned to a TCP/IP address, which will be used to address the device on the network.

3.5.2 Setting the TCP/IP Address

The first decision you need to make is how to connect the instrument. You can connect the instrument directly to a network LAN port with a LAN cable, or you can connect it directly to the PC. When connecting the instrument directly to the PC LAN port you will need a special cable called a cross connect cable. Once connected you must establish an IP address for the instrument. An IP address consists of four groups of numbers separated by a decimal. Dynamic Host Configuration Protocol (DHCP) is typically the easiest way to configure the instrument for LAN communication. DHCP automatically assigns a dynamic IP address to a device on a network. You will need to enter the IP address on the Interface screen of the GUI to control the power source.

The GUI has a built in utility that let's you determine the IP address assigned by the network DHCP server. It may also be used to set a static IP address. To use the LAN option, CSWGui version 2.1.0.0 or higher is required. The latest CSWGui version can be downloaded from the California Instrument web site. (www.programmablepower.com)

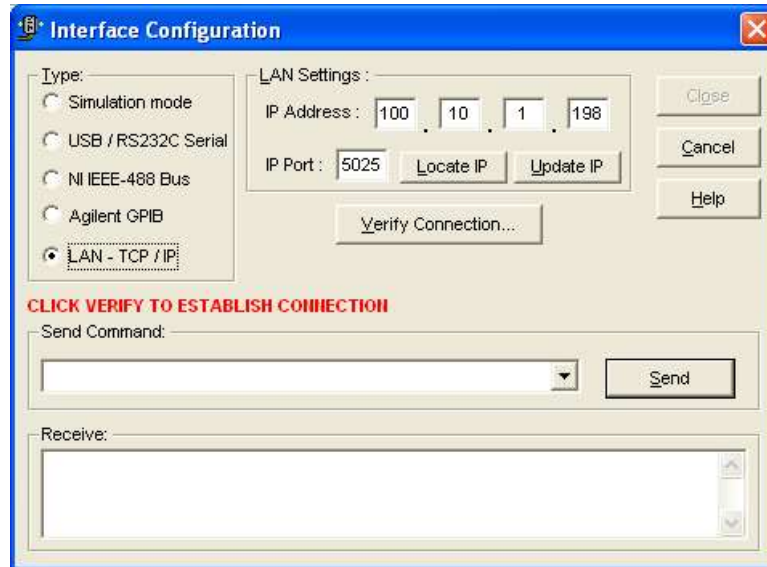

Use the “Locate IP” button on the interface configuration screen to bring up the IP configuration utility screen. To determine what IP address was assigned, select the “Get IP Address from MAC Address” in the Configuration selection. The MAC address should be listed on the serial tag on the back of the unit. Enter the MAC address and click on “Get IP Address”.

This process may take several minutes to complete so be patient. If the IP address is found, it will be displayed below the MAC address. If it can't be found, all zero's will be displayed instead.

Close the program to return to the GUI interface configuration screen. Then use the “Update IP” button to transfer the new IP address into the GUI IP Address box. You can also enter the IP address manually.

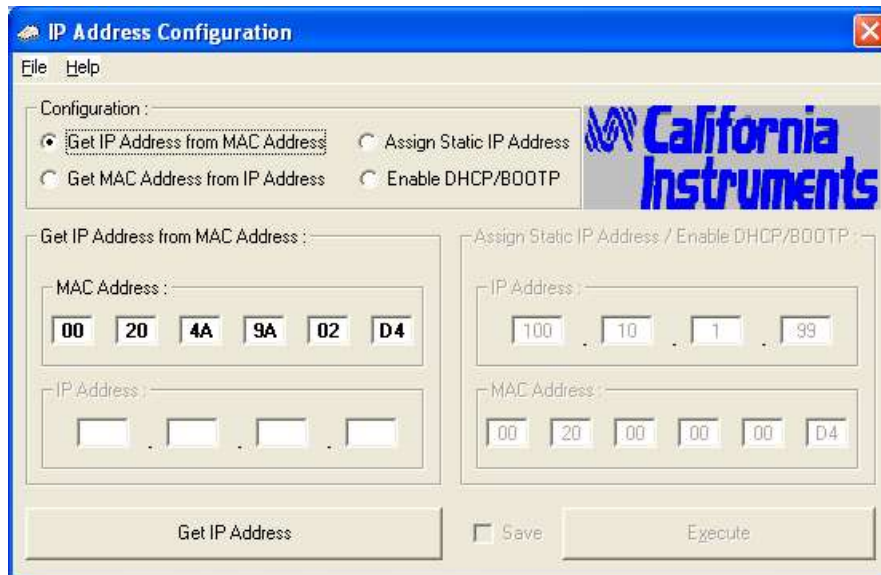

The same IP Configuration utility can be used to set the power source LAN option to either static IP or DHCP IP mode. See the on line help for further instructions.

3.5.3 Socket Port Number

Now that a connection has been verified, you can develop your application code. If you are using one of the Microsoft environments, the Winsock protocol which is part of the Windows operating system can be used. Similar capabilities are supported on other operating systems.

To use Winsock, you will have to specify the port number of the power source's LAN interface. The port number determines the protocol for the communication. The power source uses ASCII characters and instrument SCPI commands for remote control. The IANA registered Port number for the Instrument SCPI interface is 5025.

TCP Remote port = 5025

The port number is factory set to 5025.

3.5.4 IP Ping

You can also test the IP address from your Windows PC. An easy way to do so is to use the ping utility under MS DOS. To do so, bring up a DOS window using the start menu:

Start>Programs>Accessories>Command Prompt)

At the command prompt type

ping <IP address>.

This will send an IP ping request to the power source. For this to work, the power source must be turned on and connected to the same network as the PC. Also, the power source interface configuration must be set to use a baud rate of 460,800. If everything is working it will look like this:

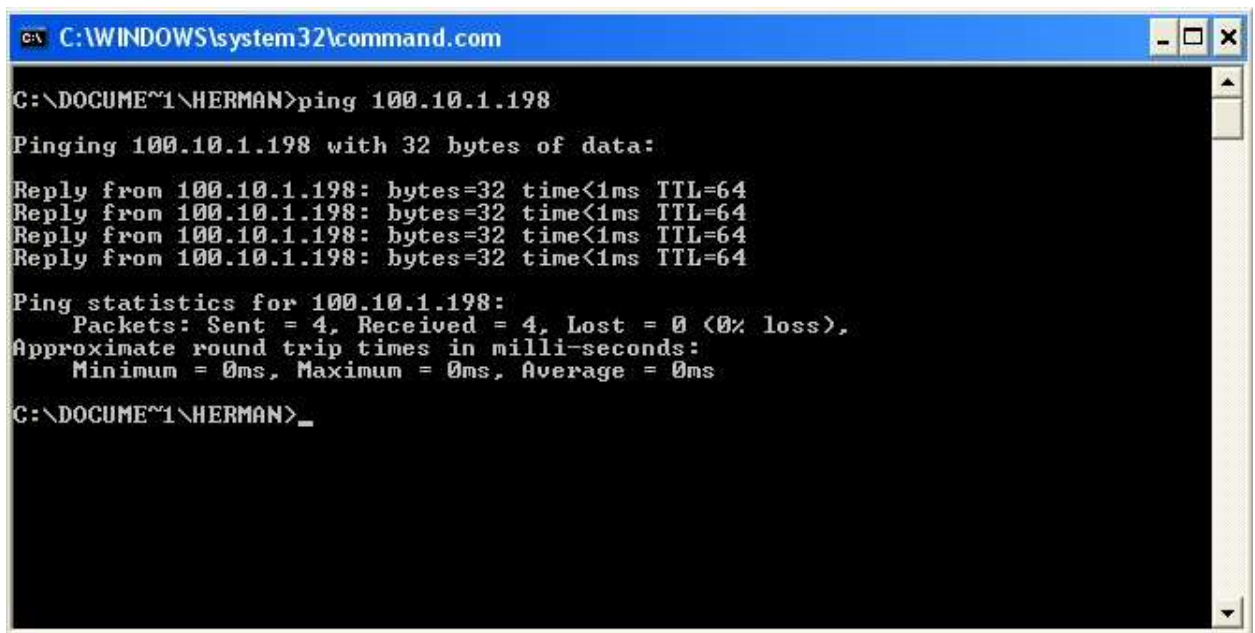

```
C:\WINDOWS\system32\command.com
C:\DOCUMENTS\HERMAN>ping 100.10.1.198
Pinging 100.10.1.198 with 32 bytes of data:
Reply from 100.10.1.198: bytes=32 time<1ms TTL=64
Reply from 100.10.1.198: bytes=32 time<1ms TTL=64
Reply from 100.10.1.198: bytes=32 time<1ms TTL=64
Reply from 100.10.1.198: bytes=32 time<1ms TTL=64
Ping statistics for 100.10.1.198:
    Packets: Sent = 4, Received = 4, Lost = 0 (0% loss),
    Approximate round trip times in milli-seconds:
        Minimum = 0ms, Maximum = 0ms, Average = 0ms
C:\DOCUMENTS\HERMAN>_
```

Figure 3-5: Pinging AC Source LAN IP address.

4. SCPI Command Reference

4.1 Introduction

Related Commands

Where appropriate, related commands or queries are included. These are listed because they are either directly related by function, or because reading about them will clarify or enhance your understanding of the original command or query.

Subsystem commands

Subsystem commands are specific to AC/DC source functions. They can be a single command or a group of commands. The groups are comprised of commands that extend one or more levels below the root. The description of common commands follows the description of the subsystem commands.

The subsystem command groups are listed in alphabetical order and the commands within each subsystem are grouped alphabetically under the subsystem. Commands followed by a question mark (?) take only the query form. When commands take both the command and query form, this is noted in the syntax descriptions.

IEEE 488.2 common commands

Common commands are defined by the IEEE-488.2 standard and are described in chapter 0 of this manual.

4.2 Calibration Subsystem

The commands in this subsystem allow you to do the following:

- Enable and disable the calibration mode
- CALibration the measured current and voltage.
- CALibration the current and voltage output levels.

Note: See the CSW user manual M162084-01 for specific calibration settings.

The commands in this subsystem allow you to do the following:

Subsystem Syntax

CALibration		
:PASSword		Allows entry of calibration password required to change calibration coefficients
:SAVE		Saves new or modified calibration coefficients
:MEASure		
:CURRent		
[:AC]		
[:FSCale]		CALibration full-scale AC current measurements
:DC		
[:FSCale]		CALibration full-scale DC current measurements
:ZERO		Cancel DC current measurements offset
:VOLTage		
[:AC]		
[:FSCale]		CALibration full-scale AC voltage measurements
:DC		
[:FSCale]		CALibration full-scale AC voltage measurements
:ZERO		Cancel AC voltage measurements offset
EXTernal		
[:FSCale]		CALibration full-scale External ADC for RPV or EXT
:OFFSet		
[:RMS]		CALibration Low end signal for External ADC for RPV or EXT
:DC		CALibration offset DC value for External ADC for RPV or EXT
[:SOURce]		
:PHASe		CALibration output phase angle relative to external sync.
:VOLTage		
[:AC]		
:LRANge		
[:FSCale]		CALibration full-scale output voltage at low voltage range
:ZERO		Trim output voltage offset at low voltage range.
:HRANge		
[:FSCale]		CALibration full-scale output voltage at high voltage range
:ZERO		Trim output voltage offset at high voltage range.
:HFRequency		Calibration data for the IEC413 from 400Hz to 2400Hz.

:DC
 :LRANge
 [:FSCale] CALibration full-scale output dc voltage at low
 voltage range.
 :ZERO Trim output dc voltage offset at low voltage range.
 :HRANge
 [:FSCale] CALibration full-scale output dc voltage at high
 voltage range. (positive DC)
 :ZERO Trim output dc voltage offset at high voltage range.

Password

CALibration:PASSword

This command allows the entry of the calibration password. The calibration password is required to use the data entry form of the calibration commands. Without the use of this password, only the query form can be used to query any calibration coefficient but no new calibration can be performed. Calibration queries always return two values. The first value is the calibration coefficient itself, the second value is the temperature associated with that coefficient. All temperature coefficients except for full-scale AC voltage are computed by the AC/DC power source controller.

The calibration password is defined as the numeric portion of the AC/DC power source serial number spelled backwards. The password needs to be enclosed by single or double quotation marks. Thus, if the units serial number is HK12345, the calibration password is "54321" and the command syntax would be:

```
CAL:PASS "54321"
```

Note that any non-numeric characters such as the HK in the example shown here need to be discarded when sending the calibration password. Only the numeric portion is to be used.

Command Syntax	CALibration:PASSword<SRD>
Parameters	<numeric portion of serial number reversed> (default)
Examples	CAL:PASS '34593' CAL:PASS "35461"
Related Commands	*IDN?

4.2.1 **Save****CALibration:SAVE**

This command saves all calibration coefficients to non-volatile memory. This command should be issued after all calibration adjustments have been made. If not, all changes will be lost when unit is turned off and the previous calibration values will take effect the next time the unit is powered up.

Note: *Saving calibration data to non-volatile memory requires more time to process by the CSW controller than other commands. As such, it is recommended to hold off on sending additional commands for about 300 msecs*

Command Syntax	CALibration:SAVE<SRD>
Parameters	None
Examples	CAL:SAVE
Related Commands	CAL:PASS

4.2.2 Current Measurement

CALibration:MEASure:CURRent[:AC][:FSCale] <NRf>

This command initiates the calibration of the AC current measurement at full scale.

Command Syntax	CALibration:MEASure:CURRent[:AC][:FSCale]
Parameters	<NRf> (actual load current measured with external device)
Examples	CAL:MEAS:CURR 11.5
Query Syntax	CALibration:MEASure:CURRent?
Returned Parameters	<NR2> (value range -1000 to +1000)

CALibration:MEASure:CURRent:DC[:FSCale] <NRf>

This command initiates the calibration of the DC current measurement at full scale.

Command Syntax	CALibration:MEASure:CURRent:DC[:FSCale]
Parameters	<NRf> (actual load current measured with external device)
Examples	CAL:MEAS:CURR:DC 11.5
Query Syntax	CALibration:MEASure:CURRent:DC?
Returned Parameters	<NR2> (value range -1000 to +1000)

4.2.3 Voltage Measurement

CALibration:MEASure:VOLTage[:AC][:FSCale] <NRf>

This command initiates the calibration of the rms voltage measurement at full scale.

Command Syntax	CALibration:MEASure:VOLTage[:AC][:FSCale]
Parameters	<NRf> (actual rms output voltage measured with external device)
Examples	CAL:MEAS:VOLT 120
Query Syntax	CALibration:MEASure:VOLTage?
Returned Parameters	<NR2> (value range -1000 to +1000)

CALibration:MEASure:VOLTage:DC[:FSCale] <NRf>

This command initiates the calibration of the DC voltage measurement at full scale.

Command Syntax	CALibration:MEASure:VOLTage:DC[:FSCale]
Parameters	<NRf> (actual DC output voltage measured with external device)
Examples	CAL:MEAS:VOLT:DC 120
Query Syntax	CALibration:MEASure:VOLTage:DC?
Returned Parameters	<NR2> (value range -1000 to +1000)

4.2.4 External Signal Input

CALibration:MEASure:EXTernal[:FSCale] <NRf>

This command initiates the calibration of the converter used to measure the level of the External Signal input. The numerical value to be entered, NRf, is the expected output voltage of the power source with the respective External Input signal. For the REF EXT program the expected output voltage is 62.4 times Vrms, the External input voltage for the 312V range. It is 31.2 times Vrms for the 156V range. The maximum Vrms is 5.00 Vrms.

For the REF RPV program mode the output is 44.13 times Vdc, the External DC input, on the 312V range or 22.07 for the 156V range. The power source out voltage is AC with the DC control input. Refer to the User Manual for additional calibration information for all External Signal Input calibrations.

Command Syntax	CALibration:MEASure:EXTernal[:FSCale]
Parameters	<NRf> (actual DC output voltage measured with external device)
Examples	CAL:MEAS:VOLT:DC 120
Query Syntax	CALibration:MEASure:VOLTage:EXT?
Returned Parameters	<NR2> (value range -1000 to +1000)

CALibration[:SOURce]:EXTernal[:FSCale] <NRf>

This command will set the External gain with the ALC OFF. The external signal input must be set to either 5.00 Vac in the EXT mode or +7.07 VDC in the RPV mode while the value is adjusted for either 156 or 312 in the respective range.

Command Syntax	CALibration:SOURce:EXTernal
Parameters	<NRf> (value from 0 to 4095)
Examples	CAL:SOUR:EXT:FS 2012
Query Syntax	CALibration:MEASure:VOLTage?
Returned Parameters	<NR2> (value range 0 to 4095)

CALibration:MEASure:EXTernal:OFFSet:DC <NRf>

This command will zero the converter used for measuring the External Input signal. The calibration must be done with the Output Relays OPEN. The numeric value for this command is zero.

Command Syntax	CALibration:MEASure:EXTernal:OFFSet:DC: <NRf>
Parameters	<NRf> (the numeric 0)
Examples	CAL:MEAS:EXT:EXT:OFFS:DC 0
Query Syntax	CAL:MEAS:EXT:EXT:OFFS:DC?
Returned Parameters	<NR2> (value range -1000 to +1000)

4.2.5 Output Phase

CALibration:PHASe <NRf+>

The CSW Series AC/DC power source controller can be operated using its internal timebase reference, an external clock or in external sync mode. (See `FREQ:MODE` command on page 75. When using in external clock or sync mode, it may be desirable to shift the phase output with respect to the external reference. The feature may be used to create a deliberate phase offset or to compensate for phase delays that may occur in the external sync signal path. The phase calibration command can be used to program a negative or positive phase offset for phase in degrees with respect to the external sync. Note that this calibration adjustment only applies to the external clock or sync for phase A. Phase B and C are always programmed with respect to phase A and their calibration offset is with respect to phase A. The phase to be CALibrated can be selected using the `INST:NSEL` command.

The phase offset is expressed in degrees and can range from -360.0 to +360.0 degrees. The resolution of the phase angle adjustment (0.1°) is the same as the one for programming phase angles (See `[SOURce:]PHASe` command).

Command Syntax	CALibration:PHASe <NRf+>
Parameters	<NRf> (a value between -360.0 and +360.0)
Examples	CAL:PHAS -2.3
Query Syntax	CAL:PHAS?
Returned Parameters	<NR1> (value range -180.0 to +180.0)
Related Commands	FREQ:MODE [SOURce:]PHASe INST:NSEL

4.2.6 Output Calibration Command Sequence

Note that the ALC mode normally interferes with the full scale output voltage calibration. As such, to perform full scale output voltage calibration over the bus, the ALC mode must be off. This is done automatically by sending the `CAL:PASS` command. However, to use the ALC mode to obtain the correct output voltage, it must be on while the outputs are set. The specific sequence that has to be followed is shown below:

```

CAL:PASS "nnnnn"      /* Turns the calibration mode on.
INST:COUP ALL         /* Couples all phases in three mode. (Not needed in 1
                      phase mode)
VOLT nnn              /* Set desired calibration voltage level. See user manual.
FREQ nn               /* Set desired calibration frequency. See user manual.
ALC ON                /* Enable ALC to adjust output based on measurement
                      data. Note that the voltage measurement calibration must
                      be done first.
CAL:PASS "nnnnn"     /* Cal mode has been disabled by ALC ON command so it
                      must be turned on again.
INST:NSEL 1           /* Select phase A. (Not needed for single phase mode).
CAL:VOLT:AC:HRAN nnn
CAL:VOLT:AC:HRAN?    /* Optional. Returns coefficient between 0 and 65535
                      /* Repeat last three commands for phase B and C using
                      INST:NSEL 2 and INST:NSEL 3 respectively.
CAL:SAVE              /* Saves coefficient

```

This procedure applies to both AC and DC modes and high and low voltage ranges.

4.2.7 Output - AC Voltage

CALibration[:SOURce]:VOLTage[:AC][:HRANge][:FSCale] <NRf+>

This command will result in the calibration coefficient being calculated for the AC full scale output voltage at the high voltage range.

Command Syntax	CALibration:VOLTage:HRANge <NRf>
Parameters	<NRf> (value from 0 to 65535)
Examples	CAL:VOLT:HRAN 35000
Query Syntax	CALibration:VOLTage:HRANge?
Returned Parameters	<<NRf> (cal coefficient value range 0 to 65535)

CALibration[:SOURce]:VOLTage:HFRequency

This query command retrieves the harmonic calibration coefficients for the IEC413 option. This query returns a comma-separated list of seven calibration coefficients. These coefficients can only be set by performing a voltage measurement calibration.

Query Syntax	CALibration:VOLTage:HFRequency?
Returned Parameters	<CRD>
Related Commands	CAL:IHAR?

4.2.8 Output - DC Voltage**CALibration[:SOURce]:VOLTage:DC[:HRANge][:FSCale]<NRf>**

This command will result in the calibration coefficient being calculated for the DC full scale output voltage in the high voltage range.

Command Syntax	CALibration:VOLTage:DC:HRANge <NRf>
Parameters	<NRf> (value from 0 to 65535)
Examples	CAL:VOLT:DC:HRAN 35000
Query Syntax	CALibration:VOLTage:DCHRANge?
Returned Parameters	<NRf> (value from 0 to 65535)

CALibration[:SOURce]:VOLTage:DC[:HRANge]:ZERO <NRf+>

This command will set the calibration coefficient for the dc output voltage offset at the high voltage range.

Command Syntax	CALibration:VOLTage:DC:HRANge:ZERO <NRf+>
Parameters	<NRf+> (a value between -2000 and +2000)
Examples	CAL:VOLT:DC:HRAN:ZERO -1003
Query Syntax	CALibration:VOLTage:DC:HRANge:ZERO?
Returned Parameters	<NR1> (value range -2000 to +2000)

4.3 Display Subsystem

This subsystem allows text information to be send to the power source LCD display. Typical applications are to display operator prompts or program status information on the power source display.

The display on the CSW Series has a maximum capacity of 8 x 40 ASCII characters, both lower and upper case. The application program is responsible for formatting each line. No padding or length checking is performed by the power source firmware.

Subsystem Syntax

```
DISPlay
  [:WINDow]
    [:STATe]          on | off | 1 | 0
    :MODE             NORMal | TEXT | MEASurement
    :TEXT[:DATA]     "xxxxxx"
    :LOCation        <NR1>,<NR1>
```

DISPlay

This command turns the front panel display on and off. It does not affect the annunciators. In the off state, the LCD display will be blank but the backlight will remain on. Note that this state overrides the DISPlay:MODE state as well so the display will be blanked regardless of the display mode setting.

Command Syntax	DISPlay[:WINDow][:STAT]<bool>
Parameters	0 1 OFF ON
*RST Value	ON
Examples	DISP:STAT 1 DISP:STAT OFF
Query Syntax	DISPlay[:WINDow]:STAT?
Returned Parameters	0 1
Related Commands	DISP:MODE DISP:TEXT

DISPlay:MODE

This command sets the display to show either normal instrument functions, or to show a text message. Text messages are defined with DISPlay:TEXT:DATA. The MEAS mode when selected will cause the power source LCD display to revert to the MEASUREMENT 1 display whenever there is no bus activity for at least 3 seconds. This mode can be used to allow operators to view the measurement 1 screen despite having no control over the front panel.

Command Syntax	DISPlay[:WINDow]:MODE<mode>
Parameters	NORMal TEXT MEASurement
*RST Value	NORMal
Examples	DISP:MODE TEXT
Query Syntax	DISPlay[:WINDow]:MODE?
Returned Parameters	<CRD>
Related Commands	DISP DISP:TEXT

DISPlay:TEXT

This command sets the character string that is displayed when the display mode is set to TEXT. The argument is a quoted string limited to upper case alpha characters and numbers. The display is capable of showing up to 320 characters divided over 8 lines of 40 characters each. If the string exceeds the display capacity, it will be truncated.

Command Syntax	DISPlay[:WINDow]:TEXT[:DATA]<display_string>
Parameters	<display string>
*RST Value	null string
Examples	DISP:TEXT "DO TEST1"
Query Syntax	DISPlay[:WINDow]:TEXT?
Returned Parameters	<SRD> (the last programmed string)
Related Commands	DISP DISP:MODE

DISPlay:LOCation

This command sets the display pointer to a specific row and column address. Any text send with the DISP:TEXT command will be placed at this location on the display. This command takes two numeric parameters, row and column. The row range is from 1 through 8, the column range is from 1 to 40. Thus, the first character position is at 1,1, the last one is at 8,40. If a string is send that is longer than the remaining column positions on a row, it will be truncated.

Command Syntax	DISPlay[:WINDow]:TEXT:LOCation <row>,<column>
Parameters	<NR1>, <NR1>
*RST Value	n/a
Examples	DISP:TEXT:LOC 2,1
Query Syntax	n/a
Related Commands	DISP:MODE DISP:TEXT

4.4 Instrument Subsystem

The Instrument subsystem controls the phase mode of the AC/DC power source for configurations capable of operating in three phase mode.

Subsystem Syntax

INSTrument		
COUPle ALL NONE		Couples or uncouples commands
:NSElect 1 2 3		Selects phase A, B or C using numeric references
:SElect A B C		Selects phase A, B or C using character references

INSTrument:COUPle

This command may be used to couple all output phase in three phase mode. When the phases are coupled, commands issues subsequently affect all three phases. This allows the output voltage to be programmed for all three phases using a single command and without the need to select each phase individually. When uncoupled, commands issued must be preceded by the PHAS:NSEL command and will only affect the selected command.

Available parameters are ALL to couple all phases and NONE to uncouple all phases. In single phase mode, the INST:COUP commands are ignored.

Command Syntax	INSTrument:COUPle
Parameters	ALL NONE
Examples	INST:COUP ALL
Query Syntax	INST:COUP?
Returned Parameters	<CRD>
Related Commands	INST:NSEL INST:SEL

INSTrument:NSElect

This command may be used select a specific output phase in three phase mode using a numeric reference. A 1 denotes phase A, a 2 denotes phase B and a 3 denotes Phase C. As long as the instrument state is coupled however, programming command will affect all phases. As soon as the INST:COUP NONE command is issued, the last selected phase becomes selected. To immediately change the output of a single phase only, make sure the instrument state is uncoupled when issuing the INST:NSEL command.

Note that the MEASure and FETCh subsystems are not affected by the INST:COUP command and always operate on the selected phase only. This means the instrument can remain in coupled mode while doing measurement queries using "INST:NSEL <n>; FETC:VOLT?; *WAI". Note that when the instrument is subsequently put in the uncoupled state using "INST:COUP NONE", the last issued phase selection will be in effect. To make sure the desired phase is selected, follow the "INST:COUP NONE" command with an "INST:NSEL <n>" command

Command Syntax	INSTrument:NSEL
Parameters	1 2 3
Examples	INST:NSEL 1
Query Syntax	INST:NSEL?
Returned Parameters	<CRD>
Related Commands	INST:COUP INST:SEL

INSTrument:SElect

This command may be used select a specific output phase in three-phase mode using a character reference. "A" denotes phase A, "B" denotes phase B and "C" denotes Phase C. As long as the instrument state is coupled however, programming command will affect all phases. As soon as the INST:COUP NONE command is issued, the last selected phase becomes selected. To immediately change the output of a single phase only, make sure the instrument state is uncoupled when issuing the INST:SEL command.

Note that the MEASure and FETCh subsystems are not affected by the INST:COUP command and always operate on the selected phase only. This means the instrument can remain in coupled mode while doing measurement queries using "INST:SEL <n>;FETC:VOLT?;*WAI". Note that when the instrument is subsequently put in the uncoupled state using "INST:COUP NONE", the last issued phase selection will be in effect. To make sure the desired phase is selected, follow the "INST:COUP NONE" command with an "INST:SEL <n>" command

Command Syntax	INSTrument:SEL
Parameters	A B C
Examples	INST:SEL A
Query Syntax	INST:SEL?
Returned Parameters	<CRD>
Related Commands	INST:COUP INST:NSEL

4.5 Array Measurement Subsystem

This command subsystem lets you retrieve arrays containing measurement data. Only current and voltage measurements are stored in an array. Two measurement commands are available: MEASure and FETCh. A MEASure command triggers the acquisition of new data before returning the readings from the array. A FETCh command returns previously acquired data from the array.

Individual outputs of a three-phase source are specified by the setting of INSTRument:NSElect.

Subsystem Syntax

MEASure FETCh	
:ARRay	
:CURREnt	
[:DC]?	Returns the digitized instantaneous current
:HARMonic	
[:AMPLitude]?	Returns amplitudes of the first 50 harmonics
:PHASe?	Returns phase angles of the first 50 harmonics
:MODE	Selects waveform data transfer format
:VOLTage	
[:DC]?	Returns the digitized instantaneous voltage
:HARMonic	
[:AMPLitude]?	Returns amplitudes of the first 50 harmonics
:PHASe?	Returns phase angles of the first 50 harmonics

4.5.1 Current Array Data

MEASure:ARRay:CURRent[:DC]?

FETCh:ARRay:CURRent[:DC]?

Phase Selectable

These queries return an array containing the instantaneous output current in amperes. The data returned in arbitrary block data format as follows:

#5<block length n><b0><b1><b2><b3>.....<bn-3><bn -2><bn-1><bn>

where b0,b1,b2,b3 are four hex bytes represent IEEE single precision floating number, where b0 is the most significant byte and b3 is the least significant byte.

The output voltage and current are digitized whenever a measure command is given or whenever an acquire trigger occurs. The time interval between samples is:

10.4 microseconds for single-phase mode and 31.2 microseconds for three-phase mode.

The query SENSE:SWEep:TINTerval? will return the time interval, the position of the trigger relative to the beginning of the data buffer is determined by SENSE:SWEep:OFFSet.

Query Syntax	MEASure:ARRay:CURRent[:DC]? [<n>,<n>] FETCh:ARRay:CURRent[:DC]? [<n>,<n>]
Parameters	Optional block and offset parameters <n>,<n>. Where the first value <n> is the number of 256 sample blocks to transfer and the second value <n> is the first block (offset) to start with. Number of blocks is from 1 to 16, offset is from 0 to 15.
Examples	MEAS:ARR:CURR? FETC:ARR:CURR? 4,0
Returned Parameters	4096 data points in arbitrary block data format
Related Commands	INST:NSEL SENS:SWE

MEASure:ARRay:CURRent:HARMonic? [<nrf>]

FETCh:ARRay:CURRent:HARMonic? [<nrf>]

Phase Selectable

These queries return an array of harmonic amplitudes of output current in rms amperes. The first value returned is the dc component, the second value is the fundamental frequency, and so on up to the 50th harmonic. Harmonic orders can be measured up to the fundamental measurement bandwidth of the measurement system:

16 kHz in either phase mode.

Thus, the maximum harmonic that can be measured is dependent on the output frequency. Any harmonics that represent frequencies greater than the above frequencies are returned as 0.

The total number of harmonic values returned may be specified as a parameter to the query command. Only harmonic data values from 0 (dc) to the number specified will be returned. This capability may be used to reduce the transfer time by avoiding the transfer of unwanted data. If the fundamental frequency is programmed to 400 Hz for example, there is no need to query harmonics above number

Query Syntax	MEASure:ARRay:CURRent:HARMonic[:AMPLitude]? [<nrf>] FETCh:ARRay:CURRent:HARMonic[:AMPLitude]?
Parameters	None
Examples	MEAS:ARR:CURR:HARM? FETC:ARR:CURR:HARM? 20
Returned Parameters	21 NR2 values
Related Commands	INST:NSEL

MEASure:ARRay:CURRent:HARMonic:PHASe? [<nrf>]

FETCh:ARRay:CURRent:HARMonic:PHASe? [<nrf>]

Phase Selectable

These queries return an array of harmonic phases of output current in degrees, referenced to the positive zero crossing of the fundamental component. The fundamental component will return a value relative to the fundamental voltage.

The first value returned is the dc component (always returned as 0 degrees phase) , the second value is the fundamental frequency, and so on up to the 50th harmonic. Harmonic orders can be measured up to the fundamental measurement bandwidth of the measurement system:

16 kHz in either phase mode.

Thus the maximum harmonic that can be measured is dependent on the output frequency. Any harmonics that represent frequencies greater than the above frequencies are returned as 0.

Query Syntax	MEASure:ARRay:CURRent:HARMonic:PHASe?<NRf> FETCh:ARRay:CURRent:HARMonic:PHASe?<NRf>
Parameters	None
Examples	MEAS:ARR:CURR:HARM:PHAS? 16 FETC:ARR:CURR:HARM:PHAS?
Returned Parameters	17 NR2 values
Related Commands	INST:NSEL

4.5.2 Waveform Array Data Format Mode

MEASure:ARRay:MODE

This command selects the waveform array data format to be used. (Available in firmware revision 2.32 or higher only.) The default mode is binary (BIN) which uses an IEEE floating point data format in which each data sample is transferred as a 4 byte floating point binary data word. Alternatively, an ASCII format may be selected (ASCii) in which each data sample is sent as 8 ASCII Hex values representing the 4 byte IEEE floating point data. Note that the transfer mode only applies to MEAS:ARR:VOLT and MEAS:ARR:CURR queries. All other measurement queries always return ASCII data. Note that at power on, the default mode is always set to binary (BIN).

Syntax	MEASure:ARRay:MODE
Parameters	BIN ASCii
Examples	MEAS:ARR:MOD ASC
Related Commands	MEAS:ARR:VOLT MEAS:ARR:CURR

Note: The MEAS:ARR:MOD command is provided to allow waveform data transfers in ASCII on DBCS versions of MS Windows. Examples of DBCS versions are Chinese, Korean, Japanese etc. On most Windows versions, the binary mode can be used as it reduces the amount of data transferred and thus provides better throughput.

The ASCII mode will double the number of characters transferred so provisions for a larger receive buffer on the PC may have to be made. The maximum data size that can be sent with one command is 16KB. To transfer the entire 4096 waveform acquisition buffer in ASCII mode requires two separate data transfers of the first followed by the second buffer. The block size and block offset parameters may be used to accomplish this.

Conversion function sample VB6. Converting waveform data from either transfer mode to a single precision value can be accomplished using the following sample routine:

```
Public Function StringToIEEEFloat(ByVal sData As String, ByVal bAsciiMode As Boolean)
As Single
'=====
'bAsciiMode flag is used if data is received as 8 ascii chars
'representing Hex 0-9,A-F. If bAsciiMode flag is false, then
'data is process as 4 char representing a byte each. Ascii
'mode is needed for DCBS windows
'=====
    Dim i           As Integer
    Dim j           As Integer
    Dim iChar       As Integer
    Dim expo        As Long
    Dim mantisse    As Long
    Dim expo_val    As Variant
    Dim mant_f      As Single
    Dim c(3)        As Long 'Must use 32 bit integers to allow for
                           'intermediate result of 24 bit shift
    Dim sign        As Boolean
'=====
    Const MANT_MAX = &H7FFFFFFF
    Const EXPO_MAX = 2 ^ 126
'=====

    On Error GoTo FloatConvError
    If bAsciiMode Then
        'Retrieve ASC values from eight hex byte input data
        sData = UCase(sData)
        For i = 0 To 3
            c(i) = 0
        Next i
    End If
End Function
```

```

    For j = 0 To 1
      iChar = AscB(Mid$(sData, i * 2 + j + 1, 1)) - 48
      If iChar > 9 Then iChar = iChar - 7
      c(i) = c(i) * 16 * j + iChar
    Next j
  Next i
Else
  'Retrieve ASC values from four byte input data
  'Note: Don't use ASCB or ASCW functions as results will differ
  'based on character sets, even on non DCBS Windows
  'Retrieve ASC values from four byte input data
  For i = 0 To 3
    c(i) = Asc(Mid$(sData, i + 1, 1))
  Next i
End If
'Get sign bit
sign = ((c(0) And &H80) = &H80)
'Get exponent value less sign bit
expo = (c(0) And &H7F) * 2
'Pick up exponent sign
If (c(1) And &H80) = &H80 Then expo = expo Or 1
'get data less exponent sign bit
c(1) = c(1) And &H7F
mantisse = c(1) * &H10000 + c(2) * &H100 + c(3)
mant_f = mantisse / MANT_MAX
'Process exponent
If (expo <> 0) And (expo <> &HFF) Then
  expo = expo - 127
  mant_f = mant_f + 1
  expo_val = 2 ^ Abs(expo)
  If (expo > 0) Then mant_f = mant_f * expo_val
  If (expo < 0) Then mant_f = mant_f / expo_val
Else
  If (mant_f <> 0) Then
    If expo = 0 Then
      mant_f = mant_f / EXPO_MAX
    Else
      mant_f = mant_f * EXPO_MAX
    End If
  End If
End If
'Append number sign and return value
If sign Then mant_f = -mant_f
StringToIEEEFloat = mant_f
Exit Function
'=====

FloatConvError:
  'Conversion errors are truncated to zero
  StringToIEEEFloat = 0
  Exit Function

End Function

```

4.5.3 Voltage Array Data

**MEASure:ARRay:VOLTage[:DC]?
 FETCH:ARRay:VOLTage[:DC]?**

Phase Selectable

These queries return an array containing the instantaneous output voltage in volts. The data returned in arbitrary block data format as follows:

#5<block length n><b0><b1><b2><b3>.....<bn-3><bn -2><bn-1><bn>

where b0,b1,b2,b3 are four hex bytes represent IEEE single precision floating number, where bo is the most significant byte and b3 is the least significant byte.

The output voltage and current are digitized whenever a measure command is given or whenever an acquire trigger occurs. The time interval between samples is:

10.4 microseconds for single-phase mode and 31.2 microseconds for three-phase mode.

The query SENSE:SWEep:TINTerval? will return the time interval, the position of the trigger relative to the beginning of the data buffer is determined by SENSE:SWEep:OFFSet.

Query Syntax	MEASure:ARRay:VOLTage[:DC]? [<n>, <n>] FETCH:ARRay:VOLTage[:DC]? [<n>, <n>]
Parameters	Optional block and offset parameters <n>,<n>. Where the first value <n> is the number of 256 sample blocks to transfer and the second value <n> is the first block (offset) to start with. Number of blocks is from 1 to 16, offset is from 0 to 15.
Examples	MEAS:ARR:VOLT? FETC:ARR:VOLT?
Returned Parameters	4096 data points in arbitrary block data format
Related Commands	INST:NSEL SENS:SWE

**MEASure:ARRay:VOLTage:HARMonic? [<nrf>]
 FETCH:ARRay:VOLTage:HARMonic? [<nrf>]**

Phase Selectable

These queries return an array of harmonic amplitudes of output voltage in rms volts. The first value returned is the dc component, the second value is the fundamental frequency, and so on up to the 50th harmonic. Harmonic orders can be measured up to the fundamental measurement bandwidth of the measurement system:

10.4 microseconds for single-phase mode and 31.2 microseconds for three-phase mode.

Thus, the maximum harmonic that can be measured is dependent on the output frequency. Any harmonics that represent frequencies greater than above frequencies are returned as 0.

Query Syntax	MEASure:ARRay:VOLTage:HARMonic[:AMPLitude]? [<nrf>] FETCH:ARRay:VOLTage:HARMonic[:AMPLitude]? [<nrf>]
Parameters	None
Examples	MEAS:ARR:VOLT:HARM? FETC:ARR:VOLT:HARM?
Returned Parameters	51 NR2 values
Related Commands	INST:NSEL

**MEASure:ARRay:VOLTage:HARMonic:PHASe? [<nrf>]
 FETCH:ARRay:VOLTage:HARMonic:PHASe? [<nrf>]**

Phase Selectable

These queries return an array of harmonic phases of output voltage in degrees, referenced to the positive zero crossing of the fundamental component. The fundamental component will return a value relative to the fundamental voltage for phase A. Phase A will return a zero value.

The first value returned is the dc component (always returned as 0 degrees phase); the second value is the fundamental frequency, and so on up to the 50th harmonic. Harmonic orders can be measured up to the fundamental measurement bandwidth of the measurement system:

10.4 microseconds for single-phase mode and 31.2 microseconds for three-phase mode.

Thus the maximum harmonic that can be measured is dependent on the output frequency. Any harmonics that represent frequencies greater than the above frequencies are returned as 0.

Query Syntax	MEASure:ARRay:VOLTage:HARMonic:PHASe?<NRf> FETCh:ARRay:VOLTage:HARMonic:PHASe?<NRf>
Parameters	None
Examples	MEAS:ARR:VOLTage:HARM:PHAS? 30 FETC:ARR:VOLTage:HARM:PHAS?
Returned Parameters	31 NR2 values
Related Commands	INST:NSEL

4.6 Current Measurement Subsystem

This subsystem programs the current measurement capability of the AC/DC source. Two measurement commands are available: MEASure and FETCh.

- MEASure triggers the acquisition of new measurement data before returning a reading.
- FETCh returns a reading computed from previously acquired data.

Individual outputs of a three-phase source are specified by the setting of INSTrument:NSElect.

Subsystem Syntax

MEASure FETCh	
[:SCALar]	
:CURRent	
[:AC]?	Returns ac rms current
:DC?	Returns dc component of the current
:AMPLitude	
:MAX?	Returns peak current
:RESet	Reset the peak current measurements
:CREStfactor?	Returns current crestfactor
:HARMonic	
[:AMPLitude]? <n>	Returns amplitude of the Nth harmonic of current
:PHASe? <n>	Returns phase of the Nth harmonic of current
:THD?	Returns % of total harmonic distortion of current

MEASure:CURRent[:AC]?

FETCh:CURRent[:AC]?

Phase Selectable

These queries return the ac component rms current being sourced at the output terminals if the voltage mode is set for AC only, and will return the AC plus the DC component if the voltage mode is set for ACDC.

Query Syntax	MEASure[:SCALar]:CURRent[:AC]?	FETCh[:SCALar]:CURRent[:AC]?
Parameters	None	
Examples	MEAS:CURR:AC?	FETC:CURR?
Returned Parameters	<NR2>	
Related Commands	INST:NSEL	

MEASure:CURRENT:DC?**FETCh:CURRENT:DC?*****Phase Selectable***

These queries return the dc component of the output current being sourced at the output terminals. This command should be used when the voltage mode of the source is set for DC

Query Syntax	MEASure[:SCALar]:CURRENT:DC? FETCh[:SCALar]:CURRENT:DC?
Parameters	None
Examples	MEAS:CURRE? FETC:CURRE?
Returned Parameters	<NR2>
Related Commands	INST:NSEL

MEASure:CURRENT:AMPLitude:MAXimum?**FETCh:CURRENT:AMPLitude:MAXimum?*****Phase Selectable***

These queries return and hold the absolute value of the peak current as sampled over one measurement acquisition of 4096 data points. The returned value will be updated only when a larger value is found. To update the value with every measurement a peak current reset command should be used prior to the peak measurements.

Query Syntax	MEASure[:SCALar]:CURRENT:AMPLitude:MAXimum? FETCh[:SCALar]:CURRENT:AMPLitude:MAXimum?
Parameters	None
Examples	MEAS:CURRE:AMPL:MAX? FETC:CURRE:AMPL:MAX?
Returned Parameters	<NR2>
Related Commands	INST:NSEL MEAS:CURRE:AMPL:RESet

MEASure:CURRENT:AMPLitude:RESet***Phase Selectable***

This command will reset the peak current measurement to zero.

Query Syntax	MEASure[:SCALar]:CURRENT:AMPLitude:RESset.
Parameters	None
Examples	MEAS:CURRE:AMPL:RES
Returned Parameters	None
Related Commands	MEAS:CURRE:AMPL:MAX?

MEASure:CURRent:CREStfactor?**FETCh:CURRent:CREStfactor?*****Phase Selectable***

These queries return the output current crest factor. This is the ratio of peak output current to rms output current.

Query Syntax	MEASure[:SCALar]:CURRent:CREStfactor? FETCh[:SCALar]:CURRent:CREStfactor?
Parameters	None
Examples	MEAS:CURR:CRES? FETC:CURR:CRES?
Returned Parameters	<NR2>
Related Commands	INST:NSEL

MEASure:CURRent:HARMonic?**[3Pi Controller Only]****FETCh:CURRent:HARMonic?****[3Pi Controller Only]*****Phase Selectable***

These queries return the rms amplitude of the Nth harmonic of output current. The parameter is the desired harmonic number. Queries sent with a value of 0 return the dc component. A value of 1 returns the fundamental output frequency. Harmonic frequencies can be queried up to the fundamental measurement bandwidth of the measurement system:

10.4 microseconds for single-phase mode and 31.2 microseconds for three-phase mode.

Thus the maximum harmonic that can be measured is dependent on the output frequency. Any harmonics that represent frequencies greater than above frequencies are returned as 0.

Query Syntax	MEASure[:SCALar]:CURRent:HARMonic[:AMPLitude]?<NRf> FETCh[:SCALar]:CURRent:HARMonic[:AMPLitude]?<NRf>
Parameters	0 to 50
Examples	MEAS:CURR:HARM? 3 FETC:CURR:HARM? 1
Returned Parameters	<NR2>
Related Commands	INST:NSEL

MEASure:CURRent:HARMonic:PHASe?
FETCh:CURRent:HARMonic:PHASe?

[3Pi Controller Only]
[3Pi Controller Only]

Phase Selectable

These queries return the phase angle of the Nth harmonic of output current, referenced to the positive zero crossing of the fundamental component.

The parameter is the desired harmonic number. Queries sent with a value of 0 return the dc component. A value of 1 returns the fundamental output frequency. Harmonic orders can be queried up to the fundamental measurement bandwidth of the measurement system:

10.4 microseconds for single-phase mode and 31.2 microseconds for three-phase mode.

Thus the maximum harmonic that can be measured is dependent on the output frequency. Any harmonics that represent frequencies greater than above frequencies are returned as 0.

Query Syntax	MEASure[:SCALar]:CURRent:HARMonic:PHASe?<NRf> FETCh[:SCALar]:CURRent:HARMonic:PHASe?<NRf>
Parameters	0 to 50
Examples	MEAS:CURR:HARM:PHAS? 3 FETC:CURR:HARM:PHAS? 1
Returned Parameters	<NR2>
Related Commands	INST:NSEL

MEASure:CURRent:HARMonic:THD?]
FETCh:CURRent:HARMonic:THD?

[3Pi Controller Only]
[3Pi Controller Only]

Phase Selectable

These queries return the percentage of total harmonic distortion and noise in the output current.

Query Syntax	MEASure[:SCALar]:CURRent:HARMonic:THD? FETCh[:SCALar]:CURRent:HARMonic:THD?
Parameters	None
Examples	MEAS:CURR:HARM:THD? FETC:CURR:HARM:THD?
Returned Parameters	<NR2>
Related Commands	INST:NSEL

4.7 Frequency Measurement Subsystem

This subsystem programs the frequency measurement capability of the CSW Series source.

Subsystem Syntax

MEASure
[:SCALar]
:FREQUENCY? Returns the output frequency

MEASure:FREQUENCY?

This query returns the output frequency in Hertz.

Query Syntax	MEASure[:SCALar]:FREQUENCY?
Parameters	None
Examples	MEAS:FREQ?
Returned Parameters	<NR2>

4.8 Phase Measurement Subsystem

This subsystem programs the voltage phase measurement capability of the CSW Series source.

Subsystem Syntax

```
MEASure | FETCh
  [:SCALar]
  :PHASe?
```

Returns the output voltage phase angle for the selected phase.

MEASure:PHASe?

FETCh:PHASe?

This query returns the output voltage phase angle for the selected phase in degrees. The phase angle for phase A is 0 degree if internal sync is used (default). Phase B and C are measured with respect to phase A. (relative phase angle with respect to A.)

The phase being measured or fetched is determined by the INST:NSEL command. The phase selection must be set prior to sending the MEAS command. The Fetch version may be used to obtain the readings for other phases without triggering a new measurement.

Note: *There is no equivalent command for querying the current phase angles. However, the Harmonic measurement array function may be used for this on 3Pi models. Select n = 1 to query the fundamental phase angle of the current with respect to the voltage.*

Query Syntax	MEASure[:SCALar]:PHASe?
Parameters	None
Examples	MEAS:PHAS? FETC:PHAS?
Returned Parameters	<NR2>
Related Commands	INST:NSEL

4.9 Power Measurement Subsystem

This subsystem programs the power measurement capability of the CSW Series source.

Subsystem Syntax

```

MEASure | FETCh
  [:SCALar]
    :POWer
      [:AC]
        [:REAL]?           Returns real power
        :APParent?       Returns VA
        PFACTor?         Returns power factor
      :DC                 Return the dc component of power measurement

```

MEASure:POWer[:AC]?

FETCh:POWer[:AC]?

Phase Selectable

This query returns the in-phase component of power being sourced at the output terminals in kilo watts (KW).

Query Syntax	MEASure[:SCALar]:POWer[:AC][:REAL]?
Parameters	None
Examples	MEAS:POW:AC?
Returned Parameters	<NR2>
Related Commands	INST:NSEL

MEASure:POWer:AC:APParent?

FETCh:POWer[:AC]:APParent?

Phase Selectable

This query returns the apparent power being sourced at the output terminals in kilo volt-amperes (KVA).

Query Syntax	MEASure[:SCALar]:POWer[:AC]:APParent?
Parameters	None
Examples	MEAS:POW:AC:APP?
Returned Parameters	<NR2>
Related Commands	INST:NSEL

MEASure:POWer:AC:PFACTOR?**FETCh:POWer[:AC]:PFACTOR?*****Phase Selectable***

This query returns the output power factor. The power factor is computed as:

$$\text{power factor} = \text{real power} / \text{apparent power}$$

Query Syntax	MEASure[:SCALar]:POWer[:AC]:PFACTOR?
Parameters	None
Examples	MEAS:POW:PFACTOR?
Returned Parameters	<NR2>
Related Commands	INST:NSEL

MEASure:POWer:DC?**FETCh:POWer:DC?*****Phase Selectable***

This query returns the DC component of the power being sourced at the output terminals in kilo watts (KW). The query should be used only when the voltage mode is set for DC or an error message will be generated.

Query Syntax	MEASure[:SCALar]:POWer:DC?
Parameters	None
Examples	MEAS:POW?
Returned Parameters	<NR2>
Related Commands	INST:NSEL

4.10 Voltage Measurement Subsystem

This subsystem programs the voltage measurement capability of the CSW Series. Two measurement commands are available: MEASure and FETCh. MEASure triggers the acquisition of new measurement data before returning a reading. FETCh returns a reading computed from previously acquired data.

Individual outputs of a three-phase source are specified by the setting of INSTRument:NSElect.

Subsystem Syntax

MEASure FETCh	
[:SCALar]	
:VOLTage	
[:AC]?	Returns ac rms voltage
:DC?	Returns the dc component of the voltage
:HARMonic	
[:AMPLitude]? <n>	Returns amplitude of the Nth harmonic of voltage
:PHASe? <n>	Returns phase of the Nth harmonic of voltage
:THD?	Returns % of total harmonic distortion of voltage

MEASure:VOLTage[:AC]?

FETCh:VOLTage[:AC]?

Phase Selectable

These queries return the ac rms voltage being sourced at the output terminals.

Query Syntax	MEASure[:SCALar]:VOLTage:AC?	FETCh[:SCALar]:VOLTage:AC?
Parameters	None	
Examples	MEAS:VOLT:AC?	FETC:VOLT:AC?
Returned Parameters	<NR2>	
Related Commands	INST:NSEL	

MEASure:VOLTage:DC?

FETCh:VOLTage:DC?

Phase Selectable

These queries return the dc component of the output voltage being sourced at the output terminals. This command should be used when the voltage mode is set for DC or ACDC

Query Syntax	MEASure[:SCALar]:VOLTage[:DC]?	FETCh[:SCALar]:VOLTage[:DC]?
Parameters	None	
Examples	MEAS:VOLT?	FETC:VOLT?
Returned Parameters	<NR2>	
Related Commands	INST:NSEL	

MEASure:VOLTage:HARMonic?
FETCh:VOLTage:HARMonic?

[3Pi Controller Only]
[3Pi Controller Only]

Phase Selectable

These queries return the rms amplitude of the Nth harmonic of output voltage. The parameter is the desired harmonic number. Queries sent with a value of 0 return the dc component. A value of 1 returns the fundamental output frequency. Harmonic orders can be queried up to the fundamental measurement bandwidth of the measurement system:

10.4 microseconds for single-phase mode and 31.2 microseconds for three-phase mode.

Thus the maximum harmonic that can be measured is dependent on the output frequency. Any harmonics that represent frequencies greater than above frequencies are returned as 0.

Query Syntax	MEASure[:SCALar]:VOLTage:HARMonic[:AMPLitude]?<NRf> FETCh[:SCALar]:VOLTage:HARMonic[:AMPLitude]?<NRf>
Parameters	0 to 50
Examples	MEAS:VOLT:HARM? 3 FETC:VOLT:HARM? 1
Returned Parameters	<NR2>
Related Commands	INST:NSEL

MEASure:VOLTage:HARMonic:PHASe?
FETCh:VOLTage:HARMonic:PHASe?

[3Pi Controller Only]
[3Pi Controller Only]

Phase Selectable

These queries return the phase angle of the Nth harmonic of output voltage, referenced to the positive zero crossing of the fundamental component.

The parameter is the desired harmonic number. Queries sent with a value of 0 return the dc component. A value of 1 returns the fundamental output frequency. Harmonic orders can be queried up to the fundamental measurement bandwidth of the measurement system:

10.4 microseconds for single-phase mode and 31.2 microseconds for three-phase mode.

Thus the maximum harmonic that can be measured is dependent on the output frequency. Any harmonics that represent frequencies greater than above frequencies are returned as 0.

Query Syntax	MEASure[:SCALar]:VOLTage:HARMonic:PHASe?<NRf> FETCh[:SCALar]:VOLTage:HARMonic:PHASe?<NRf>
Parameters	0 to 50
Examples	MEAS:VOLT:HARM:PHAS? 3 FETC:VOLT:HARM:PHAS? 1
Returned Parameters	<NR2>
Related Commands	INST:NSEL

MEASure:VOLTage:HARMonic:THD?
FETCH:VOLTage:HARMonic:THD?

[3Pi Controller Only]
[3Pi Controller Only]

Phase Selectable

These queries return the percentage of total harmonic distortion and noise in the output voltage.

Query Syntax	MEASure[:SCALar]:VOLTage:HARMonic:THD? FETCH[:SCALar]:VOLTage:HARMonic:THD?
Parameters	None
Examples	MEAS:VOLT:HARM:THD? FETC:VOLT:HARM:THD?
Returned Parameters	<NR2>
Related Commands	INST:NSEL

4.11 Output Subsystem

This subsystem controls the main outputs, the signal outputs and the output impedance [-3Pi models only] of the AC/DC source.

Subsystem Syntax

OUTPut		
[:STATe] <bool>		Enable/disable output voltage, current, power, etc.
:IMMediate <bool>		Open relay without programming down first
:PROTection		
:CLEAr		Reset latched protection
:RI		
[:LEVe] LOW HIGH		Sets Remote Inhibit input level mode.
:MODE <mode>		set remote inhibit input (LATC LIVE OFF)
:TTLTrg		
:MODE TRIG FSTR		Sets or disabled Function strobe mode.
[:STATe] <bool>		Enable/disable trigger out drive
:SOURce <source>		Selects a TTLTrg source (BOT EOT LIST)
:IMPedance		
[:STATe] <bool>		Enable/disable output impedance program
:REAL		Sets resistive part of output impedance
:REACtive		Sets inductive part of output impedance
:DFI		
[:STATe] <bool>		Enable/disable DFI output
:SOURce <source>		Selects an event source (QUES OPER ESB RQS OFF)

4.11.1 Output Relay

OUTPut[:STATe]

This command enables or disables the source output. The state of a disabled output is an output voltage amplitude set to 0 volts, with output relays opened. The query form returns the output state.

Note: On three phase CSW systems with firmware revision below 0.31, it is recommended to set the phase coupling to ALL before closing the output relay to ensure all phases are correctly programmed. E.g. "inst:coup all::outp 1".

Command Syntax	OUTPut[:STATe]<bool>
Parameters	0 OFF 1 ON
*RST Value	OFF
Examples	OUTP 1 OUTP:STAT ON
Query Syntax	OUTPut[:STATe]?
Returned Parameters	0 1
Related Commands	VOLT:RANGE

OUTPut:IMMEDIATE

This command opens the output relay without first programming the voltage down if the –SNK option is installed and the CSW is in REGENERATIVE mode (REG:STAT ON). If not, this command works exactly the same as the OUTP[:STAT] command. This mode may be used to simulate line loss in inverter applications. The query form returns the output state.

Command Syntax	OUTPut:IMMEDIATE<bool>
Parameters	0 OFF 1 ON
*RST Value	OFF
Examples	OUTP:IMM 1 OUTP:IMM OFF
Query Syntax	OUTPut:IMMEDIATE?
Returned Parameters	0 1
Related Commands	REG:STAT REG:CURR

4.11.2 Output Protection**OUTPut:PROTECTION:CLEAR**

This command clears the latch that disables the output when an overvoltage (OV), overcurrent (OC), overtemperature (OT), or remote inhibit (RI) fault condition is detected. All conditions that generated the fault must be removed before the latch can be cleared. The output is then restored to the state it was in before the fault condition occurred.

Command Syntax	OUTPut:PROTECTION:CLEAR
Parameters	None
Examples	OUTP:PROT:CLE
Related Commands	OUTP:PROT:DEL *RCL *SAV

4.11.3 Output Remote Inhibit Modes**OUTPut:RI[:LEVEL]**

This command sets the remote inhibit level mode. Factory default is LOW, which requires a contact closure to open the output relay. The level can be reversed by setting it to HIGH. Once set, the RI level setting is retained each time the power source is powered up. Note that this command is only implemented with firmware revision 0.28 or higher. Lower firmware revisions only provide the default LOW setting (CSW15 excluded).

Command Syntax	OUTPut:RI:LEVEL
Parameters	LOW HIGH
*RST Value	LOW
Examples	OUTP:RI:LEV HIGH
Query Syntax	OUTP:RI:LEV?
Returned Parameters	<CRD>
Related Commands	OUTP

NOTE: When using the Remote Inhibit input, it will be necessary to disconnect any RI connection to the CSW master unit when turning on the CSW master unit. During initialization, the RI connection must be **OPEN** or initialization will be halted with the message **WAITING FOR AUXILIARY** displayed on the LCD screen.

OUTPut:RI:MODE

This command selects the mode of operation of the Remote Inhibit protection. The following modes can be selected:

LATChing	A TTL low at the RI input latches the output in the protection shutdown state, which can only be cleared by OUTPut:PROTection:CLEar.
LIVE	The output state follows the state of the RI input. A TTL low at the RI input turns the output off; a TTL high turns the output on.
OFF	The instrument ignores the RI input.

The RI output state is saved at power down. The factory default state is LIVE.

Command Syntax	OUTPut:RI[:MODE] <mode>
Parameters	LATChing LIVE OFF
*RST Value	LIVE
Examples	OUTP:RI:MODE LIVE
Query Syntax	OUTPut:RI:MODE?
Returned Parameters	<CRD>
Related Commands	OUTP:PROT:CLE

4.11.4 Output DFI

OUTPut:DFI

This command enables or disables the discrete fault indicator (DFI) signal to the CSW Series. The DFI is an active high open collector output with internal pull up to 5Vdc.

Command Syntax	OUTPut:DFI[:STATe]<bool>
Parameters	0 1 OFF ON
*RST Value	OFF
Examples	OUTP:DFI 1 OUTP:DFI OFF
Query Syntax	OUTPut:DFI[:STATe]?
Returned Parameters	0 1
Related Commands	OUTP:DFI:SOUR

OUTPut:DFI:SOURce

This command selects the source for DFI events. The choices are:

QUESTionable	Questionable summary bit
OPERation	Operation summary bit
ESB	Standard Event summary bit
RQS	Request Service summary bit
OFF	Never true

Command Syntax	OUTP:DFI:SOUR<source>
Parameters	QUES OPER ESP RQS OFF
*RST Value	OFF
Examples	OUTP:DFI:SOUR OPER
Query Syntax	OUTPut:DFI:SOUR?
Returned Parameters	<CRD>
Related Commands	OUTP:DFI

4.11.5 External Trigger Output

OUTPut:TTLTrg:MODE

This command sets the operation of the Trigger Out signal to either Function Strobe or Trigger mode. The factory default is Trigger state which means the OUTP:TTLT:STAT command is required to generate outputs. In Function Strobe mode, an output pulse is generated automatically any time an output parameter such as voltage, frequency or phase is programmed. The AC source Trigger Out signal is available at the BNC connector on the rear of the power source.

Note that the desired mode must be set after turning on the power source as it is not retained as part of the INIT subsystem.

Command Syntax	OUTPut:TTLTrg:MODE TRIG FSTR
Parameters	TRIG FSTR
*RST Value	TRIG
Examples	OUTP:TTLT:MODE FSTR
Query Syntax	OUTPut:TTLTrg:MODE?
Returned Parameters	<CRD>
Related Commands	OUTP:TTLT:STAT

OUTPut:TTLTrg[::STATe]

This command enables or disables the Trigger Out signal, which is available as a BNC connector on the rear panel of the AC/DC source. This signal is the same as the Function Strobe BNC output on the rear panel. If the Trigger Out state is OFF (0), these outputs operate as a function strobe. If the Trigger Out state is ON (1), an output is generated only when a 1 is placed in the TTLTrigger list.

Refer to the User Manual for pin out information and signal levels for the Trigger out or Function Strobe signal. signal.)

Command Syntax	OUTPut:TTLTrg[::STATe]<bool>
Parameters	0 1 OFF ON
*RST Value	OFF
Examples	OUTP:TTLT 1 OUTP:TTLT OFF
Query Syntax	OUTPut:TTLTrg[::STATe]?
Returned Parameters	0 1
Related Commands	OUTP:TTLT:SOUR

OUTPut:TTLTrg:SOURce

This command selects the signal source for the Trig Out signal as follows:

- BOT Beginning of transient output
- EOT End of transient output
- LIST Specified by the TTLTrg list

When an event becomes true at the selected TTLTrg source, a pulse is sent to the the function strobe on the system interface connector on the rear panel of the AC/DC source.

Command Syntax	OUTPut:TTLTrg:SOURce<source>
Parameters	BOT EOT LIST
*RST Value	BOT
Examples	OUTP:TTLT:SOUR LIST
Query Syntax	OUTPut:TTLTrg:SOURce?
Returned Parameters	<CRD>
Related Commands	OUTP:TTLT

4.12 Source Subsystem - Current

This subsystem programs the output current of the CSW Series source.

Subsystem Syntax

```
[SOURce:]
  CURRent
    [:LEVel]
      [:IMMediate]
        [:AMPLitude] <n>      Sets the rms current limit
      :PROTection
        :STATe <bool>        Select rms current limit protection mode
        :DELay                Set the delay in seconds before protection is
                              enabled
```

CURRent

Phase selectable

This command sets the rms current limit of the output. If the output current exceeds this limit, the output voltage amplitude is reduced until the rms current is within the limit if the current protection mode is disabled and the current protection delay time is expired. The CL bit of the questionable status register indicates that the current limit control loop is active. If the current protection state is programmed on, the output latches into a disabled state when current limiting occurs and the current protection delay time is expired.

Note that the CURRent command is coupled with the VOLTage:RANGe and SOURce:MODE commands. This means that the maximum current limit that can be programmed at a given time depends on the voltage range setting and the voltage mode (DC or AC) in which the unit is presently operating.

Command Syntax	[SOURce:]CURRent[:LEVel] [:IMMediate][:AMPLitude]<NRf+>
Parameters	<NR2>
Unit	A (rms amperes)
*RST	Defined by the PONSetup:CURRent
Examples	CURR 5 CURR:LEV .5
Query Syntax	[SOURce:]CURRent[:LEVel] [:IMMediate][:AMPLitude]?
Returned Parameters	<NR2>
Related Commands	CURR:PROT:STAT VOLT:RANG MODE

CURRent:PROTection:STATe

This command selects overcurrent (OC) protection mode. If the overcurrent protection function is enabled and the load current exceeds the programmed level, then the output is disabled after a time delay specified by the CURRent:PROTection:DELay and the Questionable Condition status register OC bit is set (see chapter 7). An overcurrent condition is cleared after the cause of the condition is removed.

If the (OC) protection mode is disabled, the source operates in the Constant Current mode and the output voltage will be reduced after a time delay specified by the CURRent:PROTection:DELay and the Questionable Condition status register OC bit is set. (see chapter 7). An overcurrent condition is cleared after the cause of the condition is removed.

Command Syntax	[SOURce:]CURRent:PROTection:STATe<bool>
Parameters	0 1 OFF ON
*RST Value	ON
Examples	CURR:PROT:STAT 0 CURR:PROT:STAT OFF
Query Syntax	[SOURce:]CURRent:PROTection:STATe?
Returned Parameters	0 1
Related Commands	OUTP:PROT:DEL

CURRent:PROTection:DELay

This command sets the delay time between over current limit condition and the response to this condition. At the end of the delay, if the over current condition still exists, the response will depend on the protection state.

If the protection state is on, the output voltage will fault to zero voltage. If the protection state is off, the output voltage will reduced to a value that maintains a constant current defined by the setting of the current limit.

Use CURRent:PROT:DEL to prevent momentary current limit conditions caused by programmed output changes or load changes from tripping the overcurrent protection.

Command Syntax	[SOURCE:] CURRent: PROTection:DELay
Parameters	0.1 to 5
Unit	seconds
*RST Value	100 milliseconds
Examples	CURR:PROT:DEL 1.5
Query Syntax	CURR:PROT:DEL?
Returned Parameters	<NR2>
Related Commands	OUTP:PROT:STATE

4.13 Source Subsystem - Frequency

This subsystem programs the output frequency of the AC/DC source.

Subsystem Syntax

[SOURce:]		
FREQUENCY		
:IMMEDIATE] <n>		Sets the frequency
:MODE <mode>		Sets frequency mode (FIX STEP PULS LIST SENS EXT)
:SLEW		
[:IMMEDIATE] <n> MAXimum		Sets the frequency slew rate
:MODE <mode>		Sets frequency slew mode (FIX STEP PULS LIST)
:TRIGGERED <n> MAXimum		Sets the triggered frequency slew rate
:TRIGGERED <n>		Sets the triggered frequency

FREQUENCY

This command sets the frequency of the output waveform.

Command Syntax	[SOURce:]FREQUENCY[:CW]:IMMEDIATE] <NRf+>
Parameters	Refer to specifications table in User Guide
Unit	Hz (Hertz)
*RST Value	60 Hz
Examples	FREQ 50
Query Syntax	[SOURce:]FREQUENCY?
Returned Parameters	<NR3>
Related Commands	FREQ:MODE FREQ:SLEW

FREQUENCY:MODE

This command determines how the output frequency is controlled. The choices are:

FIXed	The output frequency is unaffected by a triggered output transient.
STEP	The output frequency is programmed to the value set by FREQUENCY:TRIGGERED when a triggered transient occurs.
PULSe	The output frequency is changed to the value set by FREQUENCY:TRIGGERED for a duration determined by the pulse commands.
LIST	The output frequency is controlled by the frequency list when a triggered transient occurs.
SENSe	Selects external sync mode.
EXTernal	Selects external clock input.

Command Syntax	[SOURce:]FREQUENCY:MODE <mode>
Parameters	FIXed STEP PULSe LIST SENSe EXT
*RST Value	FIXed
Examples	FREQ:MODE FIX
Query Syntax	[SOURce:]FREQUENCY:MODE?
Returned Parameters	<CRD>
Related Commands	FREQ FREQ:TRIG

FREQUENCY:SLEW

This command sets the rate at which frequency changes for all programmed changes in output frequency. Instantaneous frequency changes can be obtained by sending MAXimum.

Command Syntax	[SOURce:]FREQUency:SLEW[:IMMEDIATE] <NRf+>
Parameters	0.01 to 1E9 MAXimum
Unit	Hz (Hertz per second)
*RST Value	MAXimum
Examples	FREQ:SLEW:IMM 75FREQ:SLEW MAX
Query Syntax	[SOURce:]FREQUency:SLEW?
Returned Parameters	<NRf>
Related Commands	FREQ:SLEW:MODE FREQ

FREQUency:SLEW:MODE

This command determines how the frequency slew rate is controlled during a triggered output transient. The choices are:

- FIXed The frequency slew rate is unaffected by a triggered output transient.
- STEP The frequency slew rate is programmed to the value set by FREQUency:TRIGgered when a triggered transient occurs.
- PULSe The frequency slew rate is changed to the value set by FREQUency:TRIGgered for a duration determined by the pulse commands.
- LIST The frequency slew rate is controlled by the frequency list when a triggered transient occurs.

Command Syntax	[SOURce:]FREQUency:SLEW:MODE<mode>
Parameters	FIXed STEP PULSe LIST
*RST Value	FIXed
Examples	FREQ:SLEW:MODE FIX
Query Syntax	[SOURce:]FREQUency:SLEW:MODE?
Returned Parameters	<CRD>
Related Commands	FREQ FREQ:SLEW:TRIG

FREQUENCY:SLEW:TRIGGERed

This command sets the rate at which frequency changes during a triggered output transient. Instantaneous frequency changes can be obtained by sending MAXimum.

Command Syntax	[SOURce:]FREQUENCY:SLEW:TRIGGERed <NRf+>
Parameters	0.01 to 1E9 MAXimum
Unit	Hz (Hertz per second)
*RST Value	MAXimum
Examples	FREQ:SLEW:TRIG 75 FREQ:SLEW:TRIG MAX
Query Syntax	[SOURce:]FREQUENCY:SLEW:TRIG?
Returned Parameters	<NRf>
Related Commands	FREQ:SLEW:MODE FREQ

FREQUENCY:TRIGGERed

This command programs the frequency that the output will be set to during a triggered step or pulse transient.

Command Syntax	[SOURce:]FREQUENCY:TRIGGERed <NRf+>
Parameters	0 to maximum frequency range specified by the LIMit:FREQUENCY command
Unit	Hz (Hertz)
*RST Value	60 Hz
Example	FREQ:TRIG 50
Query Syntax	[SOURce:]FREQUENCY:TRIGGERed?
Returned Parameters	<NR2>
Related Commands	FREQ FREQ:MODE

4.14 Source Subsystem - Function

This subsystem programs the output function of the AC/DC source.

Subsystem Syntax

```
[SOURce:]
  FUNCtion
    [:SHAPe]
      [:IMMediate] <shape>      Sets the periodic waveform shape
                                (SIN|SQU|CSIN|<user-defined>)
      :MODE <mode>             Sets the waveform shape mode (FIX|LIST)
      :CSINe <n>                Sets the % THD of peak at which the clipped sine
```

FUNCTION

Phase selectable

This command selects the shape of the output voltage waveform as follows:

SINe	A sinewave is output
SQUare	A squarewave is output
CSINe	The output is a clipped sine waveform. Both positive and negative peak amplitudes are clipped at a value determined by the SOURce:FUNCtion:SHAPe:CSINusoid setting.
<user_defined>	The output shape is described by one of the user-defined waveform tables.

The maximum peak voltage that the AC source can output is 441 V peak. This includes any combination of voltage and function shape values. Therefore, the maximum value that can be programmed depends on the peak-to-rms ratio of the selected waveform. For a sinewave, the maximum voltage that can be programmed is 312 V rms. If a custom waveform is selected for a given phase, the maximum programmable rms voltage may be obtained by the program by using the `VOLT? MAX` query. This query will return the maximum possible rms voltage that can be programmed without exceeding the 441 Volt peak voltage limitation. This feature can be used to avoid unnecessary error messages during program execution.

Note: ***You cannot program a voltage that produces a higher peak voltage on the output than a 312 Vrms sinewave when in the 312 V range.***

Command Syntax	[SOURce:]FUNCtion[:SHAPe][:IMMediate]<shape>
Parameters	SINusoid SQUare CSINe <waveform_name>
*RST Value	SINe
Examples	FUNC SIN FUNC TABLE1
Query Syntax	[SOURce:]FUNCtion[:SHAPe]?
Returned Parameters	<CRD>
Related Commands	FUNC:MODE

FUNCTION:MODE***Phase selectable***

This command determines how the waveform shape is controlled during a triggered output transient. The choices are:

- FIXed The waveform shape is unaffected by a triggered output transient.
 LIST The waveform shape is controlled by the waveform shape list when a triggered transient occurs.

Command Syntax	[SOURce:]FUNCTION[:SHAPE]:MODE<mode>
Parameters	FIXed STEP PULSe LIST
*RST Value	FIXed
Examples	FUNC:MODE LIST
Query Syntax	[SOURce:]FUNCTION[:SHAPE]:MODE?
Returned Parameters	<CRD>
Related Commands	FUNC

FUNCTION:CSINe***Phase selectable***

This command sets the clipping level when a clipped sine output waveform is selected. The clipping characteristics can be specified as follows:

- The clipping level is expressed as the percentage of total harmonic distortion in the output voltage. The range is 0 to 20 percent.

Command Syntax	[SOURce:]FUNCTION[:SHAPE]:CSINusoid<NRf>
Parameters	0 to 20%
*RST Value	0% (no clipping)
Examples	FUNC:CSIN 10
Query Syntax	[SOURce:]FUNCTION[:SHAPE]:CSINusoid?
Returned Parameters	<NR2>
Related Commands	FUNC:MODE

4.15 Source Subsystem - Limit

This subsystem controls the voltage frequency and current limit of the power source. These limits are set at the factory and depend on the power source rating. It is not accessible by the user. The query format is accessible however.

Subsystem Syntax

```
[SOURce:]
  LIMit
    FREQuency <n1>,<n2>
    VOLTage <n>
    CURRent <n>
    PHASe <n>
```

LIMit:FREQuency

This command sets the upper and lower frequency limit of the power source. Only the query format of this command is available.

Command Syntax	[SOURce:]LIMit:FREQuency <NRf> , <NRf>
Parameters	low freq limit, upper frequency limit [command protected]
Query Syntax	[SOURce:]LIMit:FREQuency?
Returned Parameters	<NR2>, <NR2>

LIMit:CURRent

This command will set or return the maximum current limit the power source will operate at in the low voltage range. Only the query format of this command is available.

Command Syntax	[SOURce:]LIMit:CURRent <NRf>
Parameters	maximum current limit at low voltage range [command protected]
Query Syntax	[SOURce:]LIMit:CURRent?
Returned Parameters	<NR2>

LIMit:VOLTage

This command will set or return the available voltage ranges of the power source. A set of three parameters is returned on the query, each value representing one of the up to three available AC voltage ranges of the CSW Series. The first parameter represents the 156 V range value, the second the 312 V range. Note that the equivalent DC range values are not returned, even in the CSW unit is in DC mode. To determine the actual DC range value, use the VOLT:RANG? Query command.

Only the query format of this command is available.

Command Syntax	[SOURce:]LIMit:VOLTage <NRf> , <NRf> , <NRf>
Parameters	voltage ranges [command protected]
Query Syntax	[SOURce:]LIMit:VOLTage?
Returned Parameters	<NR2> , <NR2> , <NR2>
Example:	LIM:VOLT? Response = 156.0,312.0 The CSW unit has a 156 V low range, a 312 V high range.

LIMit:PHASe

This command will configure the power source controller for the number of output phases. A value of zero will configure the source as a single-phase unit. A value of 120° will configure the power source controller as a three phase unit with a 120° phase offset between phase A, B and C. Any other value will configure the controller as a two phase unit using phase A and C.

Command Syntax	[SOURce:]LIMit:PHASe<NRf>
Parameters	0 to 360 [command protected]
Query Syntax	[SOURce:]LIMit:PHASe?
Returned Parameters	<NR2>

4.16 Sense Subsystem - Sweep

This subsystem controls the measurement current range, the data acquire sequence, and the harmonic measurement window of the AC source.

Subsystem Syntax

```
SENSe
  :SWEep
    :OFFSet <n>           Define trigger points relative to the start of
                          the digitizer data record
    :TINTerval?          Query the digitizer sample spacing
```

SENSe:SWEep:OFFSet

This command defines the trigger point relative to the start of the returned data record when an acquire trigger is used. The values can range from:

-42 msec to 1000 msec in a single-phase configuration and from -128 msec to 1000 msec in a three-phase configuration.

When the value specified is negative (less than 0 msec), the values in the beginning of the data record represent samples taken prior to the actual trigger moment.

Command Syntax	SENSe:SWEep:OFFSet <NRf+>	
Parameters	-42 to 1000 for single phase configuration -128 to 1000 for three phase configuration	
*RST Value	0	
Examples	SENS:SWE:OFFS -5	
Query Syntax	SENSe:SWEep:OFFSet?	
Returned Parameters	<NR2>	
Related Commands	SENS:SWE:TINT?	MEAS:ARR

SENSe:SWEep:TINterval

This command and its query format allow setting the time period between samples **when voltage and current digitization is controlled by the acquire trigger sequence**. The query response of the sample period query will be:

10.4 to 104 μ sec for single phase and 31.2 to 312 μ sec for three phase AC/DC source configurations respectively. The value of TINT must be set in increments of 10.4 or 31.2 μ sec. The controller will round to the nearest available multiple of 10.4 or 31.2 μ sec.

Command Syntax	SENSe:SWEep:TINterval <NRf+>	
Parameters	10.4 to 104 for single phase configuration 31.2 to 312 for three phase configuration	
*RST Value	10.4 or 31.2	
Examples	SENS:SWE:TINT-150	
Query Syntax	SENSe:SWEep:TINterval?	
Returned Parameters	<NR2>	
Related Commands	SENS:SWE:OFFS	MEAS:ARR

4.17 Source Subsystem - List

This subsystem controls the generation of complex sequences of output changes with rapid, precise timing and synchronized with internal or external signals. Each subsystem command for which lists can be generated has an associated list of values that specify the output at each list step. LIST:COUNT determines how many times the source sequences through a list before that list is completed. LIST:REPEAT determines how many times each data point will repeat. LIST:DWELL specifies the time interval that each value (point) of a list is to remain in effect. LIST:STEP determines if a trigger causes a list to advance only to its next point or to sequence through all of its points.

All active subsystems that have their modes set to LIST must have the same number of points (up to 100), or an error is generated when the first list point is triggered. The only exception is a list consisting of only one point. Such a list is treated as if it had the same number of points as the other lists, with all of the implied points having the same value as the one specified point.

MODE commands such as VOLTage:MODE LIST are used to activate lists for specific functions. However, the LIST:DWELL command is active whenever any function is set to list mode. Therefore, LIST:DWELL must always be set either to one point, or to the same number of points as the active list.

Subsystem Syntax

[SOURce:]

LIST

:COUNT <n> MAXimum	Sets the list repeat count
:DWELL <n> ,<n> :POINTs?	Sets the list of dwell times Returns the number of dwell list points
:FREQUENCY [:LEVel] <n> ,<n> :POINTs?	Sets the frequency list Returns the number of frequency points
:SLEW <n> ,<n> :POINTs?	Sets the frequency slew list Returns the number of frequency slew points
:FUNCTION [:SHAPe] <shape>,<shape> :POINTs?	Sets the waveform shape list Returns the number of shape points
:REPEAT [:COUNT] <n>,<n> :POINTs?	Set the repeat count for each data points. Returns the number of repeat for each data points
:STEP ONCE AUTO	Defines whether list is dwell- or trigger-paced
:TTLTrg <bool> ,<bool> :POINTs?	Defines the output marker list Returns the number of output marker list points
:VOLTage [:LEVel] <n> ,<n> :POINTs?	Sets the voltage list Returns the number of voltage level points
:SLEW <n> ,<n> :POINTs?	Sets the voltage slew list Returns the number of voltage slew points

4.17.1 List - Count

LIST:COUNT

This command sets the number of times that the list is executed before it is completed. The command accepts parameters in the range 1 through 2E8.

Command Syntax	[SOURce:]LIST:COUNT<NRf+>
Parameters	1 to 2E8 MINimum MAXimum
*RST Value	1
Examples	LIST:COUN 3 LIST:COUN MAX
Query Syntax	[SOURce:]LIST:COUNT?
Returned Parameters	<NRf>
Related Commands	LIST:FREQ LIST:TTLT LIST:VOLT

4.17.2 List - Dwell

LIST:DWELI

This command sets the sequence of list dwell times. Each value represents the time in seconds that the output will remain at the particular list step point before completing the step. At the end of the dwell time, the output of the source depends upon the following conditions:

- If LIST:STEP AUTO has been programmed, the output automatically changes to the next point in the list.
- If LIST:STEP ONCE has been programmed, the output remains at the present level until a trigger sequences the next point in the list.

The order in which the points are entered determines the sequence in which they are output when a list is triggered.

Command Syntax	[SOURce:]LIST:DWELI<NRf+> ,<NRf+>
Parameters	0.001 to 9E4 MINimum MAXimum
Unit	S (seconds)
Examples	LIST:DWEL .1,.5,1.5
Query Syntax	[SOURce:]LIST:DWEL?
Returned Parameters	<NR2>
Related Commands	LIST:FREQ LIST:TTLT LIST:VOLT

LIST:DWELI:POINts?

This query returns the number of points specified in LIST:DWELI. Note that it returns only the total number of points, not the point values.

Query Syntax	[SOURce:]LIST:DWELI:POINts?
Returned Parameters	<NR1>
Example	LIST:DWEL:POIN?
Related Commands	LIST:DWELI

4.17.3 List - Frequency

LIST:FREQuency

This command sets the sequence of frequency list points. The frequency points are given in the command parameters, which are separated by commas. The order in which the points are entered determines the sequence in which they are output when a list is triggered.

Command Syntax	[SOURce:]LIST:FREQuency[:LEVel]<NRf+>,<NRf+>
Parameters	Values limited to the frequency range
Unit	HZ (Hertz)
Examples	LIST:FREQ 60,65,70
Query Syntax	[SOURce:]LIST:FREQ?
Returned Parameters	<NR2>
Related Commands	LIST:FREQ:POIN? LIST:COUN LIST:DWEL LIST:STEP LIST:FREQ:SLEW

LIST:FREQuency:POINts?

This query returns the number of points specified in LIST:FREQuency. Note that it returns only the total number of points, not the point values.

Query Syntax	[SOURce:]LIST:FREQ[:LEVel]:POINts?
Returned Parameters	<NR1>
Example	LIST:FREQ:POIN?
Related Commands	LIST:FREQ

LIST:FREQuency:SLEW

This command sets the sequence of frequency slew list points. The frequency points are given in the command parameters, which are separated by commas. The order in which the points are entered determines the sequence in which they are output when a list is triggered.

Command Syntax	[SOURce:]LIST:FREQuency:SLEW<NRf+>,<NRf+>
Parameters	0.01 to 1E9 MAXimum
Unit	HZ (Hertz) per second
Examples	LIST:FREQ:SLEW 10, 1E2, MAX
Query Syntax	[SOURce:]LIST:FREQ:SLEW?
Returned Parameters	<NR3>
Related Commands	LIST:FREQ:SLEW:POIN? LIST:COUN LIST:DWEL LIST:STEP LIST:FREQ

LIST:FREQuency:SLEW:POINts?

This query returns the number of points specified in LIST:FREQuency:SLEW. Note that it returns only the total number of points, not the point values.

Query Syntax	[SOURce:]LIST:FREQ:SLEW:POINts?
Returned Parameters	<NR1>
Example	LIST:FREQ:SLEW:POIN?
Related Commands	LIST:FREQ:SLEW

4.17.4 **List:Waveform Function**

LIST:FUNCTION[:SHAPE]

Phase Selectable

This command sets the sequence of the waveform shape entries. The order in which the shapes are given determines the sequence in which the list of shape will be output when a list transient is triggered. The following shapes may be specified:

- SINe A sinewave is output
- SQUare A squarewave is output
- CSIN The output is a clipped sine waveform. Both positive and negative peak amplitudes are clipped at a value determined by the SOURce:FUNCTION:SHAPE:CSINusoid setting.
- <waveform_name> The output shape is described by one of the user-defined waveform tables.

The maximum peak voltage that the AC source can output is 425 V peak. This includes any combination of voltage and function shape values. Therefore, the maximum value that can be programmed depends on the peak-to-rms ratio of the selected waveform. For a sinewave, the maximum voltage that can be programmed is 300 V rms. If a custom waveform is selected for a given phase as part of the function list, the maximum programmable rms voltage of the corresponding voltage list point or the end voltage which results from the previous list point's voltage and the voltage slew rate times the dwell time should not exceed the maximum possible rms value for the selected custom waveform or an execution error will be generated and the transient list will not execute.

Command Syntax	[SOURce:]LIST:FUNCTION[:SHAPE] <shape>[, <shape>]
Parameters	depends on the available shape defined by the TRACe:CAT?
Examples	LIST:FUNC SIN,ARRAY,TRIANG
Query Syntax	[SOURce:]LIST:FUNC[:SHAPE]?
Returned Parameters	<CRD>
Related Commands	LIST:FUNC:POIN? LIST:COUN LIST:DWEL LIST:STEP LIST:VOLT

LIST:FUNCTION:POINTS?

This query returns the number of points specified in LIST:FUNC. Note that it returns only the total number of points, not the point values.

Query Syntax	[SOURce:]LIST:VOLTage:POINTS?
Returned Parameters	<NR1>
Example	LIST:VOLT:POIN?
Related Commands	LIST:VOLT

4.17.5 List - Repeat

LIST:REPeat[:COUNT]

This command sets the sequence of repeat values for each data list point. The repeat values are given in the command parameters, which are separated by commas. The order in which the points are entered determines the sequence in which they are repeated when a list is triggered.

Command Syntax	[SOURce:]LIST:REPeat[:COUNT] <NRf+>,<NRf+>
Parameters	0 to 99
Examples	LIST:REPeat 1,0,5
Query Syntax	[SOURce:]LIST:REPeat?
Returned Parameters	<NR1>
Related Commands	LIST:PHAS:POIN? LIST:COUN LIST:DWEL LIST:STEP

LIST:REPeat:POINTs?

This query returns the number of points specified in LIST:REPeat. Note that it returns only the total number of points, not the point values.

Query Syntax	SOURce:]LIST:PHAS:POINTs?
Returned Parameters	<NR1>
Example	LIST:PHAS:POIN?
Related Commands	LIST:FREQ LIST:DWEL

4.17.6 List - Step

LIST:STEP

This command specifies how the list sequencing responds to triggers.

- ONCE causes the list to advance only one point after each trigger. Triggers that arrive during a dwell delay are ignored.
- AUTO causes the entire list to be output sequentially after the starting trigger, paced by its dwell delays. As each dwell delay elapses, the next point is immediately output.

Command Syntax	[SOURce:]LIST:STEP<step>
Parameters	ONCE AUTO
*RST Value	AUTO
Examples	LIST:STEP ONCE
Query Syntax	[SOURce:]LIST:STEP?
Returned Parameters	<CRD>
Related Commands	LIST:COUN LIST:DWEL

4.17.7 List:TTL Trigger Out

LIST:TTLTrg

This command sets the sequence of Trigger Out list points. Each point which is set ON will cause a pulse to be output at Trigger Out (Function strobe signal on the system interface) when that list step is reached. Those entries which are set OFF will not generate Trigger Out pulses. The order in which the list points are given determines the sequence in which Trigger Out pulses will be output when a list transient is triggered.

Command Syntax	[SOURce:]LIST:TTLTrg<bool> ,<bool>
Parameters	0 1 OFF ON
Examples	LIST:TTLT 1,0,1 LIST:TTLT ON,OFF,ON
Query Syntax	LIST:TTLT?
Returned Parameters	0 1
Related Commands	LIST:TTLT:POIN? LIST:COUN LIST:DWEL LIST:STEP OUTP:TTLT:STAT OUTP:TTLT:SOUR

LIST:TTLTrg:POINTs?

This query returns the number of points specified in LIST:TTLT. Note that it returns only the total number of points, not the point values.

Query Syntax	[SOURce:]LIST:TTLTrg:POINTs?
Returned Parameters	<NR1>
Example	LIST:TTLT:POIN?
Related Commands	LIST:TTLT

4.17.8 List:Voltage

LIST:VOLTage

Phase Selectable

This command specifies the output voltage points in a list. The voltage points are given in the command parameters, which are separated by commas. The order in which the points are entered determines the sequence in which the list will be output when a list transient is triggered.

Command Syntax	[SOURce:]LIST:VOLTage[:LEVel] <NRf+>,<NRf+>
Parameters	Value depends on the voltage range and the voltage mode
Unit	V (rms voltage)
Examples	LIST:VOLT 2.0,2.5,3.0 LIST:VOLT MAX,2.5,MIN
Query Syntax	[SOURce:]LIST:VOLTage[:LEVel]?
Returned Parameters	<NR2>
Related Commands	LIST:VOLT:POIN? LIST:COUN LIST:DWELLIST:STEP LIST:SHAP LIST:VOLT:OFFS

LIST:VOLTage:POINTs?

Phase Selectable

This query returns the number of points specified in LIST:VOLT. Note that it returns only the total number of points, not the point values.

Query Syntax	[SOURce:]LIST:VOLTage:POINTs?
Returned Parameters	<NR1>
Example	LIST:VOLT:POIN?
Related Commands	LIST:VOLT

LIST:VOLTage:SLEW

Phase Selectable

This command specifies the output offset slew points in a list. The slew points are given in the command parameters, which are separated by commas. The order in which the points are entered determines the sequence in which the list will be output when a list transient is triggered. Changing list data while a subsystem is in list mode generates an implied ABORT.

Command Syntax	[SOURce:]LIST:VOLTage:SLEW <NRf+>,<NRf+>
Parameters	0.1 to 1E9 MAX
Unit	V/S (volts per second)
Example	LIST:VOLT:SLEW 10, 1E2, MAX
Query Syntax	[SOURce:]LIST:VOLTage:SLEW?
Returned Parameters	<NR2>
Related Commands	LIST:VOLT:SLEW:POIN? LIST:COUN LIST:DWEL LIST:STEP

LIST:VOLTage:SLEW:POINts?***Phase Selectable***

This query returns the number of points specified in LIST:VOLTage:SLEW. Note that it returns only the total number of points, not the point values.

Query Syntax	[SOURce:]LIST:VOLTage:SLEW:POINts?
Returned Parameters	<NR1>
Example	LIST:VOLT:SLEW:POIN?
Related Commands	LIST:VOLT:SLEW

4.18 Source Subsystem - Mode

The MODE command allows switching between the different output modes available on the AC/DC power source. The CSW Series with a –1 or –3 provides either AC or DC mode while the CSW Series with a –1Pi or –3Pi adds AC+DC mode as well. When switching modes, the output is automatically set to zero to prevent hot switching of the output. After a mode command, the output voltage needs to be programmed to the desired setting.

Subsystem Syntax

[SOURce:]
 MODE AC | DC | ACDC Sets the output mode

MODE

The mode command switches the output voltage between the available output modes.

Command Syntax	[SOURce:]MODE
Parameters	AC DC ACDC
Example	MODE AC
Query Syntax	[SOURce:]MODE?
Returned Parameters	<CRD>
Related Commands	PONS:VOLT:MODE

4.19 Source Subsystem - Phase

This subsystem programs the output phase angle of the AC/DC source. When the phase command is used to program a single-phase unit, the only discernible effect is to cause an instantaneous shift in the output waveform phase relative to an external reference signal.

Subsystem Syntax

```
[SOURce:]
  PHASe
    [:IMMEDIATE] <n>           Sets the output phase
```

PHASe

Phase Selectable

This command sets the phase of the output voltage waveform relative to an external reference for single-phase power source. Phase B and C in a three phase system are programmed relative to phase A. The phase angle is programmed in degrees. Positive phase angles are used to program the leading phase, negative phase angles are used to program the lagging phase.

Command Syntax	[SOURce:]PHASe[:IMMEDIATE] <NRf+>
Parameters	-360 through +360
*RST Value	Define by the PONSetup:PHASe
Examples	PHAS 45
Query Syntax	[SOURce:]PHASe?
Returned Parameters	<NR2>

4.20 Source Subsystem - PONSetup

This subsystem will control the initial condition of the power source at the power on state.

Subsystem syntax

```
[SOURce:]
  PONSetup:
    ALControl 0|1|OFF|ON          Set initial ALC state.
    CLOCK INT|EXT                 Set the the clock source to internal or external
    CURRent <n>                   Set the current limit
    FREQuency <n>                 Set the frequency value
    NOUtput ONEPhase|THReephase|LAST
                                  Set the command language
    OLOad
      [:MODE] CVOL|CCUR          Set the over load mode const voltage or const
                                  current
    OUTPut
      [:RELay] 0|1|OFF|ON        Set the state of the output relay
    PHASe
      [:ANGLE]                   Set the phase angle relative to external
    SENSE INT|EXT                 Set the voltage sense to internal or external
    VOLTag
      [:LEVel] <n>               Set the voltage level
      MODE DC|AC|ACDC            Set the voltage mode
      REFerence INT|EXT|RPV      Set the voltage reference input source
    VRANge 150|300|400           Set the voltage range
    WGRoup <n>                   Set the wave group to 0...3    [3Pi Controller
                                  Only]
```

PONSetup:ALControl

This command sets the initial ALC mode to either On or Off at power on.

Command Syntax	[SOURce:]PONSetup:ALControl <NRf+>
Parameters	0 1 OFF ON
Examples	PONS:ALC 0
Query Syntax	PONS:ALC?
Returned Parameters	0 1

PONSetup:CLOCK

This command determines the source of its clock at the power on. if internal, the source uses its internal clock. if external, a clock source must be supplied on the appropriate input.

Command Syntax	[SOURce:]PONSetup:CLOCK <source>
Parameters	INTernal EXTernal
Examples	PONSetup:CLOCK INT
Query Syntax	PONSetup:CLOCK?
Returned Parameters	<CRD>
Related Commands	FREQ:MODE

PONSetup:CURRENT

This command sets the initial current limit at the power on. The maximum allowable current is controlled by the voltage range and voltage mode.

Command Syntax	[SOURce:]PONSetup:CURRENT <NRf+>
Parameters	range set by the LIMit:CURRENT, voltage mode and voltage range
Examples	PONS:CURR 22
Query Syntax	PONS:CURR?
Returned Parameters	<NR2>

PONSetup:FREQUENCY

This command sets the initial frequency of the power source at the power on.

Command Syntax	[SOURce:]PONSetup:FREQUENCY <NRf+>
Parameters	set by the LIMit:FREQUENCY
Examples	PONS:FREQ 50
Query Syntax	PONS:FREQ?
Returned Parameters	<NR2>

PONSetup:NOUtput

This command sets the configuration of the power source to one phase or three phase if this option is enabled. The LAST setting causes the unit to power up in the mode it was left.

Command Syntax	[SOURce:]PONSetup:NOUtput <selection>
Parameters	ONEPhase THReephase LAST
Examples	PONS:NOUtput LAST
Query Syntax	PONS:NOUtput?
Returned Parameters	<CRD>

PONSetup:OLOad[:MODE]

This command determines how the power source will react to an over current condition. In const current mode, the output voltage is reduced to a value that maintains a constant load current. In constant voltage mode, the output faults to an initial value if the over current condition is maintained beyond the protection delay period.

Command Syntax	[SOURce:]PONSetup:OLOad[:MODE] <mode>
Parameters	CCURrent CVOLyage
Examples	OLOad CCUR
Query Syntax	PONS:OLO?
Returned Parameters	<CRD>
Related Commands	CURR:PROT:STAT

PONSetup:OUTPut[:RELAy]

This command sets the initial state of the output relay at the power on.

Command Syntax	[SOURce:]PONSetup:OUTPut[:RELAy <boolean>
Parameters	0 1 OFF ON
Examples	OUTP ON OUTP 0
Query Syntax	PONS:OUTP?
Returned Parameters	0 1

PONSetup:PHASe[:ANGLe]

This command sets the initial phase angle of the power source relative to external reference.

Command Syntax	[SOURce:]PONSetup:PHASe[:ANGLe <NRf+>
Parameters	± 360
Examples	PONS:PHAS 0
Query Syntax	PONS:PHAS?
Returned Parameters	<NR2>

PONSetup:SENSe

This command determines the source of its voltage sense at the power on. if internal, the source uses its connection to sense its output voltage. if external, the sense connection must be connected at the load.

Command Syntax	[SOURce:]PONSetup:SENSe <source>
Parameters	INTernal EXTernal
Examples	PONSetup:SENSe INT
Query Syntax	PONSetup:SENS?
Returned Parameters	<CRD>
Related Commands	VOLTage:SENSe

PONSetup:VOLTage[:LEVel]

This command sets the output voltage level at the power on. This voltage level can not exceed the limit at the initial voltage range.

Command Syntax	[SOURce:]PONSetup:VOLTage[:LEVel] <NRf+>
Parameters	set by the LIMit:VOLTage and voltage mode AC or DC
Examples	PONS:VOLT 0
Query Syntax	PONS:VOLT?
Returned Parameters	<NR2>

PONSetup:VOLTage:MODE

This command sets the initial voltage mode at the power on. This mode is DC or AC

Command Syntax	[SOURce:]PONSetup: VOLTage:MODE
Parameters	AC DC ACDC [ACDC on 3Pi Controller Only]
Examples	PONS: VOLTage:MODE DC
Query Syntax	PONS: VOLTage:MODE?
Returned Parameters	<CRD>

PONSetup:VOLTage:REFerence

This command sets the initial voltage reference source at the power on.

Command Syntax	[SOURce:]PONSetup: VOLTage:REF
Parameters	INT EXT RPV
Examples	PONS: VOLTage:REF RPV
Query Syntax	PONS: VOLTage:REF?
Returned Parameters	<CRD>

PONSetup:VRANge

This command sets the initial voltage range of the power source.

Command Syntax	[SOURce:]VRANge<NRf+>
Parameters	150 200 300 400
Examples	PONS:VRAN 150
Query Syntax	PONS:VRAN?
Returned Parameters	<NR2>

PONSetup:WGRoup**[3Pi Controller Only]**

This command determines the source of its waveform storage. It has a total of 4 groups. Change of group requires power down, an IEEE-488 Device Clear (not available when using the RS232C interface) or a *RST command to take effect.

Command Syntax	[SOURce:]PONSetup:WGRoup <n>
Parameters	0 1 2 3
Examples	PONSetup:WGRoup 2
Query Syntax	PONSetup:WGR?
Returned Parameters	<NR1>
Related Commands	TRACe:CAT?

4.21 Source Subsystem - Pulse

This subsystem controls the generation of output pulses. The PULSe:DCYClE, PULSe:PERiod, and PULSe:WIDTh commands are coupled, which means that the values programmed by any one of these commands can be affected by the settings of the others. Refer to Table 4-1 and Table 4-2 under PULSe:HOLD for an explanation of how these commands affect each other.

Subsystem Syntax

```
[SOURce:]
PULSe
    :COUNT <n> | MAXimum      Selects transient pulse count
    :DCYClE <n>                Selects pulse duty cycle
    :PERiod <n>                Selects pulse period when the count is greater than
                                1
    :WIDTh <n>                Selects width of the pulses
    :HOLD WIDTh|DCYClE        Select which parameter to hold during programming
```

PULSe:COUNT

This command sets the number of pulses that are output when a triggered output transient occurs. The command accepts parameters in the range 1 through 2E8. If MAXimum is sent, the output pulse repeats indefinitely.

Command Syntax	[SOURce:]PULSe:COUNT<NRf+>
Parameters	1 to 2E8 MINimum MAXimum
*RST Value	1
Examples	PULS:COUN 3 PULS:COUN MIN PULS:COUN MAX
Query Syntax	[SOURce:]PULS:COUNT?
Returned Parameters	<NR2>
Related Commands	PULS:DCYC PULS:PER PULS:WIDT

PULSe:HOLD

This command specifies whether the pulse width or the duty cycle is to be held constant when the pulse period changes. The following tables describe how the duty cycle, period, and width are affected when one parameter is set in a single program message. if two or three parameters are set in a single message, there sequence will define how they will be affected.

Command Syntax	[SOURce:]PULSe:HOLD<parameter>
Parameters	WIDTh DCYClE
*RST Value	WIDTh
Examples	PULS:HOLD DCYC
Query Syntax	[SOURce:]PULSe:HOLD?
Returned Parameters	<CRD>
Related Commands	PULS:COUN PULS:DCYC PULS:PER PULS:WIDT

Parameter Set			Action
DCYClE	PERiod	WIDTh	
		√	Sets WIDTh. If WIDTh < PERiod, recalculates DCYClE; otherwise, recalculates the PERiod and DCYClE.
	√		Sets PERiod. If WIDTh < PERiod, recalculates DCYClE; otherwise, recalculates the PERiod and DCYClE.
√			Sets DCYClE and recalculates PERiod

Table 4-1 : PULSe:HOLD = WIDTh parameters

Parameter Set			Action
DCYClE	PERiod	WIDTh	
		√	Sets WIDTh and recalculates the PERiod
	√		Sets PERiod and recalculates the WIDTh
√			Sets DCYClE and recalculates PERiod

Table 4-2 : PULSe:HOLD = DCYClE parameters

PULSe:DCYClE

This command sets the duty cycle of the triggered output pulse. The duty cycle units are specified in percent.

Command Syntax	[SOURce:]PULSe:DCYClE<NRf+>
Parameters	0 to 100% MINimum MAXimum
*RST Value	50%
Examples	PULS:DCYC 75 PULS:DCYC MAX
Query Syntax	[SOURce:]PULSe:DCYClE?
Returned Parameters	<NR2>
Related Commands	PULS:COUN PULS:PER PULS:WIDT

PULSe:PERiod

This command sets the period of a triggered output transient The command parameters are model-dependent.

Command Syntax	[SOURce:]PULSe:PERiod<NRf+>
Parameters	2 msecs to 90,000 secs MINimum MAXimum
Unit	S (seconds)
*RST Value	1 sec
Examples	PER 0.001PER MIN
Query Syntax	[SOURce:]PERiod?
Returned Parameters	<NR2>
Related Commands	PULS:COUN PULS:DCYC PULS:WIDT

PULSe:WIDTh

This command sets the width of a transient output pulse. The command parameters are model-dependent.

Command Syntax	[SOURce:]PULSe:WIDTh<NRf+>
Parameters	1 msec to 90,000 secs MINimum MAXimum
Unit	S (seconds)
*RST Value	0.5 secs
Examples	PULS:WIDT 0.001PULS:WIDT MIN
Query Syntax	[SOURce:]PULSe:WIDTh?
Returned Parameters	<NR2>
Related Commands	PULS:COUN PULS:DCYC PULS:PER

4.22 Source Subsystem - Voltage

This subsystem programs the output voltage of the AC/DC power source.

Subsystem Syntax

[SOURce:]		
VOLTage		
:ALC ON OFF REG		Sets Automatic Level Control mode
[:LEVel]		
[:IMMediate]		
[:AMPLitude] <n>		Sets the AC rms voltage amplitude
[:AC]		
:DC		
:OFFSet		Set the DC offset value in AC+DC mode
:TRIGgered		
[:AMPLitude] <n>		Sets the transient voltage amplitude
:MODE <mode>		Sets the voltage mode (FIX STEP PULS LIST)
:RANGe		
[:LEVel] <n>		Sets the voltage range
:REFerence INT EXT RPV		Sets the voltage reference source at power up
:SENSe		
[:SOURce] INTernal EXTernal		Sets voltage sense source
:SLEW		
[:IMMediate] <n> MAXimum		Sets the voltage slew rate
:MODE <mode>		Sets voltage slew mode (FIX STEP PULS LIST)
:TRIGgered		
[:AMPLitude] <n> MAXimum		Sets the transient voltage slew rate
:XLOad OFF ON		Set the xload to off or on

VOLTage:ALC

Phase Selectable

This command enables or disables the automatic voltage level control mode. If ALC is on, the output voltage of the power source is continuously adjusted based on the voltage measurement data acquired by the controller's measurement system. This results in increased output accuracy and load regulation. If regulation cannot be maintained, an output voltage fault error is generated and the output is turned off. The regulate mode (REG) may be set to enable ALC mode but disable the output volt fault error if load regulation cannot be maintained.

Note that for the CSW15-1Pi, CSW30-3Pi, and CSW45-3Pi this mode is coupled with the OUTP:IMP commands as the ALC mode and the programmable impedance functions are mutually exclusive. Attempting to enable one while the other is active will result in a command error. The ALC mode is also inactive during transient execution, even if it is enabled.

Command Syntax	[SOURce:]VOLTage:ALC <bool>
Parameters	0 OFF 1 ON 2 REG
Unit	V/S (volts per second)
*RST Value	0
Examples	VOLT:ALC 1
Query Syntax	[SOURce:]VOLTage:ALC?
Returned Parameters	0 1 2
Related Commands	OUTP:IMP:STAT

VOLTage

Phase Selectable

This command programs the AC rms, DC or offset output voltage level of the power source. The voltage mode must be set for AC to accept an AC voltage. The Voltage mode must also be set to AC+DC to accept a DC offset value.

Command Syntax	[SOURce:]VOLTage[:LEVel][:IMMediate][:AMPLitude][:AC] <NRf+> [SOURce:]VOLTage[:LEVel][:IMMediate][:AMPLitude]:DC <NRf+> [SOURce:]VOLTage[:LEVel][:IMMediate][:AMPLitude]:OFFSet<NRf+>
Parameters	0 to maximum voltage range specified by the LIMit:VOLTage command
Unit	V (rms voltage)
*RST Value	0 volt
Examples	VOLT 250 VOLT:LEV 25
Query Syntax	[SOURce:]VOLTage[:LEVel][:IMMediate][:AMPLitude]?
Returned Parameters	<NR2>
Related Commands	[SOUR:]MODE VOLT:TRIG

VOLTage:TRIGgered

Phase Selectable

This command selects the AC rms or DC amplitude that the output voltage will be set to during a triggered step or pulse transient.

Command Syntax	SOURce:]VOLTage[:LEVel]:TRIGgered:AMPLitude]<NRf+>
Parameters	0 to maximum voltage range specified by the LIMit:VOLTage command
Unit	V (rms voltage)
*RST Value	0 volt
Examples	VOLT:TRIG 120 VOLT:LEV:TRIG 120
Query Syntax	SOURce:]VOLTage[:LEVel]:TRIGgered[:AMPLitude]?
Returned Parameters	<NR2>
Related Commands	VOLT VOLT:MODE

VOLTage:MODE***Phase Selectable***

This command determines how the output voltage is controlled during a triggered output transient. The choices are:

FIXed	The voltage is unaffected by a triggered output transient.
STEP	The voltage is programmed to the value set by VOLTage:TRIGgered when a triggered transient occurs.
PULSe	The voltage is changed to the value set by VOLTage:TRIGgered for a duration determined by the pulse commands.
LIST	The voltage is controlled by the voltage list when a triggered transient occurs.

Command Syntax	[SOURce:]VOLTage:MODE<mode>
Parameters	FIXed STEP PULSe LIST
*RST Value	FIX
Examples	VOLT:MODE LIST VOLT:MODE FIX
Query Syntax	[SOURce:]VOLTage:MODE?
Returned Parameters	<CRD>
Related Commands	VOLT:TRG VOLT

VOLTage:RANGe[:LEVel]

This command sets the voltage range of the power source. On the CSW Series, there are two voltage ranges available:

- 156 V AC or DC range
- 312 V AC or DC range

The LIM:VOLT? Query may be used to determine which AC or DC voltage ranges are available to select. Sending a parameter other than these will not be accepted.

Note that the query format of the VOLT:RANG command returns the voltage range value for the selected range and mode. In AC or AC+DC mode, an AC voltage range value is returned. In DC mode, the DC voltage range value is returned. To determine the state of the CSW unit, it may be necessary to query both the range and the mode.

Note: *On CSW units the VOLT:RANG command is also coupled with the OUTPUT command. If the output relay is closed (ON), attempting a voltage range change will result in an error message and no range change will occur. The output relay MUST be opened first by sending a OUTPUT 0 command. The output off command can be prepended to the volt:range command as part of the same message.*

The VOLTage:RANGe command is coupled with the CURRent command. This means that the maximum current limit that can be programmed at a given time depends on the voltage range setting in which the unit is presently operating.

Command Syntax	[SOURce:]VOLTage:RANGe[:LEVel] <NRf+>
Parameters	156 312
*RST Value	Defined by the PONSetup:RANGe
Examples	VOLT:RANG 156
Query Syntax	[SOURce:]VOLTage:RANGe?
Returned Parameters	<NR2>
Related Commands	LIM:VOLT?

VOLTage:REFerence

This command sets the initial voltage reference source at the power on.

Command Syntax	[SOURce:] VOLTage:REF
Parameters	INT EXT RPV
Examples	VOLTage:REF RPV
Query Syntax	VOLTage:REF?
Returned Parameters	<CRD>

VOLTage:SENSe[:SOURce]

This command selects the source from which the output voltage is sensed. The following voltage sense sources can be selected:

INTernal	This senses the voltage at the output of the power amplifier on the in-board side of the output disconnect relay.
EXTernal	This senses the output voltage at the user's sense terminals, which allows remote voltage sensing at the load.

Command Syntax	[SOURce:]VOLTage:SENSe[:SOURce] <source>
Parameters	INTernal EXTernal
*RST Value	INTernal
Examples	VOLT:SENS:SOUR INT
Query Syntax	[SOURce:]VOLTage:SENSe[:SOURce]?
Returned Parameters	<CRD>

VOLTage:SLEW

Phase Selectable

This command sets the slew rate for all programmed changes in the output voltage level of the source. A parameter of MAXimum will set the slew to its maximum possible rate. The SCPI representation for MAXimum is 1E9.

Command Syntax	[SOURce:]VOLTage:SLEW[:IMMEDIATE]<NRf+>
Parameters	0 to1E9 MAX
Unit	V/S (volts per second)
*RST Value	MAX
Examples	VOLT:SLEW 1 VOLT:SLEW MAX
Query Syntax	[SOURce:]VOLTage:SLEW[:IMMEDIATE]?
Returned Parameters	<NR3>
Related Commands	VOLT:SLEW:MODE VOLT:SLEW:TRIG

VOLTage:SLEW:MODE***Phase Selectable***

This command determines how the output voltage slew rate is controlled during a triggered output transient. The choices are:

FIXed	The slew rate is unaffected by a triggered output transient.
STEP	The slew rate is programmed to the value set by VOLTage:SLEW:TRIGgered when a triggered transient occurs.
PULSe	The slew rate is changed to the value set by VOLTage:SLEW:TRIGgered for a duration determined by the pulse commands.
LIST	The slew rate is controlled by the voltage slew list when a triggered transient occurs.

Command Syntax	[SOURce:]VOLTage:SLEW:MODE<mode>
Parameters	FIXed STEP PULSe LIST
*RST Value	FIX
Examples	VOLT:SLEW:MODE LIST VOLT:SLEW:MODE FIX
Query Syntax	[SOURce:]VOLTage:SLEW:MODE?
Returned Parameters	<CRD>
Related Commands	VOLT:SLEW:TRG VOLT:SLEW

VOLTage:SLEW:TRIGgered***Phase Selectable***

This command selects the slew rate that will be set during a triggered step or pulse transient. A parameter of MAXimum will set the slew to its maximum possible rate. The maximum allowed value is 1E9.

Command Syntax	[SOURce:]VOLTage:SLEW:TRIGgered<NRf+>
Parameters	0 to 1E9 MAXimum
Unit	V/S (volts per second)
*RST Value	MAXimum
Examples	VOLT:SLEW:TRIG 1 VOLT:SLEW:TRIG MAX
Query Syntax	[SOURce:]VOLTage:SLEW:TRIGgered?
Returned Parameters	<NR2>
Related Commands	VOLT:SLEW:MODE VOLT:SLEW

VOLTage:XLOad

This command enable or disable the xload. When enabled it provides extra stability to the loop when driving a large capacitive load. See the user manual for additional information.

Command Syntax	[SOURce:]VOLTage:XLOad ON OFF
Parameters	ON OFF
*RST Value	OFF
Examples	VOLT:XLO ON
Query Syntax	[SOURce:]VOLTage:XLOad?
Returned Parameters	Boolean

4.23 Status Subsystem Commands

This subsystem programs the AC/DC power source status registers. There are four groups of status registers;

- **Operation Status Group**
- **Questionable Status Group**
- **Questionable Instrument Isummary Group**
- **Standard Event Group**

The Standard Event group is programmed with Common commands. The Operation, Questionable, and Instrument ISummary status groups each consist of the following three registers:

Condition	Enable	Event
-----------	--------	-------

Refer to chapter 7 for more information about the status registers.

Subsystem Syntax

STATus

- :OPERation
 - :EVENT Returns the value of the event register
 - :CONDition Returns the value of the condition register
 - :ENABLE <n> Enables specific bits in the Event register
- :QUESTionable
 - :EVENT Returns the value of the event register
 - :CONDition Returns the value of the condition register
 - :ENABLE <n> Enables specific bits in the Event register
- :INSTruments
 - :ISUMmary
 - :EVENT Returns the selected phase's event register value
 - :CONDition Returns the selected phase's condition register
 - :ENABLE Enable specific bits in selected phase's Event register values

Bit Configuration of Status Operation Registers

Bit Position	15-5	4	3	1-2	0
Bit Name	not used	MEAS	TRANS	not used	CAL
Bit Weight		16	8		1

- CAL Calibration is completed
- TRANS Transient is completed
- MEAS Measurement is completed

STATus:OPERation:EVENT?

This query returns the value of the Operation Event register. The Event register is a read-only register, which holds (latches) all events. Reading the Operation Event register clears it.

Query Syntax	STATus:OPERation:EVENT?
Parameters	None
Returned Parameters	<NR1>(Register Value)
Examples	STAT:OPER:EVEN?
Related Commands	*CLS

STATus:OPERation:CONDition?

This query returns the value of the Operation Condition register. This is a read-only register, which holds the real-time (unlatched) operational status of the AC/DC power source.

Query Syntax	STATus:OPERation:CONDition?
Parameters	None
Examples	STAT:OPER:COND?
Returned Parameters	<NR1>(Register value)

STATus:OPERation:ENABLE

This command and its query set and read the value of the Operation Enable register. This register is a mask for enabling specific bits from the Operation Event register to set the operation summary bit (OPER) of the Status Byte register. The operation summary bit is the logical OR of all enabled Operation Event register bits.

Command Syntax	STATus:OPERation:ENABLE <NRf+>
Parameters	0 to 32727
Default Value	0
Examples	STAT:OPER:ENAB 32 STAT:OPER:ENAB 1
Query Syntax	STATus:OPERation:ENABLE?
Returned Parameters	<NR1>(Register value)
Related Commands	STAT:OPER:EVEN

Bit Configuration of Questionable Registers

Bit Position	13-15	12	10-11	10	9	8-5	3	2-4	1	0
Bit Name	not used	CL	not used	not used	RI	not used	OT	not used	CF	VF
Bit Weight		4096			512		8		2	1

VF	over or under voltage protection has tripped
CF	over-current protection has tripped
OT	over-temperature protection has tripped
RI	remote inhibit is active
CL	rms current limit is active

STATus:QUESTIONable[:EVENT]?

This query returns the value of the Questionable Event register. The Event register is a read-only register which holds (latches) all events. Reading the Questionable Event register clears it.

Query Syntax	STATus:QUESTIONable[:EVENT]?
Parameters	None
Returned Parameters	<NR1>(Register Value)
Examples	STAT:QUES:EVEN?
Related Commands	*CLS

STATus:QUESTIONable:CONDition?

This query returns the value of the Questionable Condition register. This is a read-only register which holds the real-time (unlatched) questionable status of the AC/DC power source.

Query Syntax	STATus:QUESTIONable:CONDition?
Example	STAT:QUES:COND?
Returned Parameters	<NR1>(Register value)

STATus:QUESTIONable:ENABLE

This command sets or reads the value of the Questionable Enable register. This register is a mask for enabling specific bits from the Questionable Event register to set the questionable summary (QUES) bit of the Status Byte register. This bit (bit 3) is the logical OR of all the Questionable Event register bits that are enabled by the Questionable Status Enable register.

Command Syntax	STATus:QUESionable:ENABLE <NRf+>
Parameters	0 to 32727
Default Value	0
Examples	STAT:QUES:ENAB 18
Query Syntax	STATus:QUESTIONable:ENABLE?
Returned Parameters	<NR1>(Register value)
Related Commands	STAT:QUES:EVEN?

STATus:QUEStionable:INSTrument:ISUMmary?***Phase Selectable***

This command returns the value of the Questionable Event register for a specific output of a three-phase AC source. The particular output phase must first be selected by `INST:NSEL`.

The Event register is a read-only register, which holds (latches) all events that are passed by the Questionable NTR and/or PTR filter. Reading the Questionable Event register clears it.

Query Syntax	STATus:QUEStionable:INSTrument:ISUMmary[:EVENT]?
Parameters	None
Returned Parameters	<NR1> (Register Value)
Examples	STAT:QUES:INST:ISUM:EVEN?
Related Commands	*CLS STAT:QUES:INST:ISUM:NTR STAT:QUES:INST:ISUM:PTR

STATus:QUEStionable:INSTrument:ISUMmary:CONDition?***Phase Selectable***

This query returns the value of the Questionable Condition register for a specific output of a three-phase AC source. The particular output phase must first be selected by `INST:NSEL`. The Condition register is a read-only register, which holds the real-time (unlatched) questionable status of the AC/DC power source.

Query Syntax	STATus:QUEStionable:INSTrument:ISUMmary:CONDition?
Example	STAT:QUES:INST:ISUM:COND?
Returned Parameters	<NR1> (Register value)

STATus:QUEStionable:INSTrument:ISUMmary:ENABLE***Phase Selectable***

This command sets or reads the value of the Questionable Enable register for a specific output of a three-phase AC source. The particular output phase must first be selected by `INST:NSEL`. The Enable register is a mask for enabling specific bits from the Questionable Event register to set the questionable summary (QUES) bit of the Status Byte register. This bit (bit 3) is the logical OR of all the Questionable Event register bits that are enabled by the Questionable Status Enable register.

Command Syntax	STATus:QUEStionable:INSTrument:ISUMmary:ENABLE <NRf+>
Parameters	0 to 32767
Default Value	0
Examples	STAT:QUES:INST:ISUM:ENAB 18
Query Syntax	STATus:QUEStionable:INSTrument:ISUMmary:ENABLE?
Returned Parameters	<NR1> (Register value)

4.24 System Commands

The system commands control the system-level functions of the AC/DC Source.

Subsystem Syntax

SYSTem	
:ERRor?	Returns the error number and error string
:VERsion?	Returns the SCPI version number
:LOCal	Go to local mode (RS-232 only)
:REMote	Go to remote mode (RS-232 only)
:CONFigure	Set system configuration, password required
[:BYTE]	
NOUT	Set the number of output phases (one or three) if the mode option is available
:ETIme?	Returns the elapse time
:TEMPerature	Returns the internal ambient temperature in °C
:COMMunicate	
:GPIB	
:ADDRess	Set GPIB address
:LAN	
:ADDRess	Set LAN IP address
:APPLY	Apply the change in setting
:CLASs	Set LAN Host bits
:DEFault	Set LAN to a default known setting
:DESCRiption	Set user description
:DNSAddress	Set LAN DNS address
:GWADdress	Set LAN Gateway
:HOST	Set the Host name.
:PASSword	Set LAN password
:PORT	Set LAN socket port address
:SERial	
:BAUD	Set the baud rate
:PARity	Set the parity type
:BITS	Set number of bits
:SBITs	Set number of stop bits

SYSTem:ERRor?

This query returns the next error number followed by its corresponding error message string from the remote programming error queue. The queue is a FIFO (first-in, first-out) buffer that stores errors as they occur. As it is read, each error is removed from the queue. When all errors have been read, the query returns 0, No Error. If more errors are accumulated than the queue can hold, the last error in the queue is -350, Too Many Errors.

Query Syntax	SYSTem:ERRor?
Parameters	None
Returned Parameters	<NR1>, <SRD>
Example	SYST:ERR?

SYSTem:VERsion?

This query returns the SCPI version number to which the AC/DC source complies. The returned value is of the form YYYY.V, where YYYY represents the year and V is the revision number for that year.

Query Syntax	SYSTem:VERSion?
Parameters	None
Returned Paramters	<NR2>
Example	SYST:VERS?

SYSTem:LOCal

This command can only be used with the RS-232 interface. It sets the interface in Local state, which enables the front panel controls.

Command Syntax	SYSTem:LOCal
Parameters	None
Example	SYST:LOC
Related Commands	SYST:REM

SYSTem:REMote

This command can only be used with the RS-232 interface. It sets the interface in the Remote state, which disables all front panel controls.

Command Syntax	SYSTem:REMote
Parameters	None
Example	SYST:REM
Related Commands	SYST:LOC

SYSTem:CONFigure[:BYTE]

This command will set the power source options. This is a protected command and requires a password. The query response is available however. Available options are returned separated by a comma.

Command Syntax	SYSTem:CONFigure
Parameters ¹	SCPI,NOUT,ADV, CLK/LOC,DO160,MIL704D,IEC411,IEC413,ABD,LF
Example	SYST:CONF SCPI,IEC411 SYST:CONF?
Returned Parameters	<CRD>
Related Commands	*OPT?

1

SYSTem:CONFigure:NOUTput

Sets the mode configuration of the power source to single-phase or a three-phase mode. The MODE option must be enabled for this command to work. If MODE option is not available, the query response will be FIX.

Command Syntax	SYSTem:CONFigure:NOUTput <noutput mode>	
Parameters	ONEPhase THReephase	
Example	SYST:CONF:NOUT ONE	
Query Syntax	SYSTem:CONF?	
Query response	ONE, THREE or FIX	Note: Query response CRD differs from parameter format on this command.
Returned Paramters	<CRD>	

SYSTem:ETIMe?

This command will return the total number of accumulated hours, minutes and seconds.

Command Syntax	SYSTem:ETIMe?
Parameters	none
Example	SYST:ETIM?
Returned Parameters	<NR1>,<NR1>,<NR1>

SYSTem:TEMPerature?

This command will return the internal ambient temperature of the AC/DC power source in degrees Celsius.

Command Syntax	SYSTem:TEMPerature?
Parameters	none
Example	SYST:TEMP?
Returned Parameters	<NR2>

SYSTem:COMMunicate:GPIB:ADDRess

This command will set the GPIB address.

Command Syntax	SYSTem:COMMunicate:GPIB:ADDRess <NRF>
Parameters	0 to 31 <listen address>
Example	SYST:COMM:GPIB:ADDR 2
Returned Parameters	<NR1>

SYSTem:COMMunicate:LAN:ADDRess

This command will set the LAN IP address. The query format returns the IP address set. To query the actual IP address used by the LAN interface (in case the IP address is not static but assigned by a DHCP server), the NCON parameter (Network Connection Setting) must be added to the query. The default value is 0.0.0.0.

Command Syntax	SYSTem:COMMunicate:LAN:ADDRess <NRF>
Parameters	ddd.ddd.ddd.ddd <IP address>
Example	SYST:COMM:LAN:ADDR 255.255.167.2
Query Syntax	SYST:COMM:LAN:ADDR? SYST:COMM:LAN:ADDR? NCON
Returned Parameters	<CRD>

SYSTem:COMMunicate:LAN:APPLY

This command will apply the changes in LAN setting. The controller will go to reset condition and the new LAN setting will take effect.

Command Syntax	SYSTem:COMMunicate:LAN:APPLY
Parameters	none
Example	SYST:COMM:LAN:APPL
Query Syntax	no query for this command
Returned Parameters	none

SYSTem:COMMunicate:LAN:CLASs

This command will set the number of host address bits or a class. The query format returns the number of bits set. To query the actual number of bits used by the LAN interface (in case the IP address is not static but assigned by a DHCP server), the NCON parameter (Network Connection Setting) must be added to the query. The default value is 8. In general Class A network is 24 bits, Class B is 16 bits and Class A is 8 bits.

Command Syntax	SYSTem:COMMunicate:LAN:CLASs <NRF>
Parameters	8 to 32
Example	SYST:COMM:LAN:CLAS 8
Query Syntax	SYST:COMM:LAN: CLAS? SYST:COMM:LAN: CLAS? NCON
Returned Parameters	<NR1>

SYSTem:COMMunicate:LAN:DEFault

This command will apply the changes in LAN setting to the default setting. The controller will go to reset condition and the default LAN setting will take effect. Both IP address and Gate way address are set to zero. The Host name is cleared. The password is reset to "admin" The unit is set to DHCP or Auto IP.

Command Syntax	SYSTem:COMMunicate:LAN:DEFault
Parameters	none
Example	SYST:COMM:LAN:DEF
Query Syntax	no query for this command
Returned Parameters	none

SYSTem:COMMunicate:LAN:DESCRiption

This command will set the user description. The description is limited to 24 characters

Command Syntax	SYSTem:COMMunicate:LAN:DESCription <SRD>
Parameters	<SRD>
Example	SYST:COMM:LAN:DESC "EVAL UNIT"
Query Syntax	SYST:COMM:LAN:DESC?
Returned Parameters	<SRD>

SYSTem:COMMunicate:LAN:GWADddress

This command will set the LAN Gateway address. The query format returns the Gateway address set. To query the actual gateway address used by the LAN interface (in case the IP address is not static but assigned by a DHCP server), the NCON parameter (Network Connection Setting) must be added to the query. The default value is 0.0.0.0.

Command Syntax	SYSTem:COMMunicate:LAN:GWADddress <NRF>
Parameters	ddd.ddd.ddd.ddd <Gateway address>
Example	SYST:COMM:LAN:GWAD 255.255.255.0
Query Syntax	SYST:COMM:LAN:GWAD? SYST:COMM:LAN:GWAD? NCON
Returned Parameters	<CRD>

SYSTem:COMMunicate:LAN:HOST

This command will set the Host name. The name is limited to 16 characters

Command Syntax	SYSTem:COMMunicate:LAN:HOST <SRD>
Parameters	<SRD>
Example	SYST:COMM:LAN:HOST "ACS"
Query Syntax	SYST:COMM:LAN:HOST?
Returned Parameters	<SRD>

SYSTem:COMMunicate:LAN:PASSword

This command will set the user password. The password is used to access to LAN configuration screen from the Web page. The default password is "admin". The description is limited to 8 characters.

Command Syntax	SYSTem:COMMunicate:LAN:PASSword <SRD>
Parameters	<SRD>
Example	SYST:COMM:LAN:PASS "admin"
Query Syntax	SYST:COMM:LAN:PASS?
Returned Parameters	<SRD>

SYSTem:COMMunicate:LAN:PORT

This command will set the socket port number. The query format returns the port number set. The default value is 5025.

Command Syntax	SYSTem:COMMunicate:LAN:PORT<NRF>
Parameters	0- 65535
Example	SYST:COMM:LAN:PORT 5025
Query Syntax	SYST:COMM:LAN: PORT?
Returned Parameters	<NR1>

SYSTem:COMMunicate:SERial:BAUD

This command will set the SERIAL communication baud rate.

Command Syntax	SYSTem:COMMunicate:SERial:BAUD <NRF>
Parameters	1200 2400 4800 9600 38400 57600 115200
Example	SYST:COMM:SER:BAUD 9600
Returned Parameters	<NR1>

SYSTem:COMMunicate:SERial:PARity

This command will set the SERIAL communication parity.

Command Syntax	SYSTem:COMMunicate:SERial:PARity <parity>
Parameters	NONE EVEN ODD
Example	SYST:COMM:SER:PAR NONE
Returned Parameters	<CRD>

SYSTem:COMMunicate:SERial:BITS

This command will set the SERIAL communication number of data bits.

Command Syntax	SYSTem:COMMunicate:SERial:BITS <NRF>
Parameters	7 8
Example	SYST:COMM:SER:BITS 8
Returned Parameters	<NR1>

SYSTem:COMMunicate:SERial:SBITs

This command will set the SERIAL communication number of stop bits.

Command Syntax	SYSTem:COMMunicate:SERial:SBITs <NRF>
Parameters	1 2
Example	SYST:COMM:SER:SBITs 1
Returned Parameters	<NR1>

4.25 Trace Subsystem Commands

This subsystem programs the output waveform of the AC/DC power source.

Subsystem Syntax

TRACe		
:CATalog?		Return list of defined waveforms
[:DATA] <waveform_name>, <n> , <n>		Assign values to a waveform
:DEFine <waveform_name>[, <waveform_name> 1024]		Create and name new waveform
:DELete		
[:NAME] <waveform_name>		Delete waveform to free its memory
:ALL		Delete all user waveforms from memory

TRACe

These commands set the values of a user-defined waveform table. The first parameter is the name of a waveform that was previously defined with TRACe:DEFine. Following the name are 1024 data points that define the relative amplitudes of exactly one cycle of the waveform. The first data point defines the relative amplitude that will be output at 0 degrees phase reference. An error will occur if exactly 1024 data points are not sent with the command.

Data points can be in any arbitrary units. The AC source scales the data to an internal format that removes the dc component and ensures that the correct ac rms voltage is output when the waveform is selected. You cannot use the predefined names as names for your waveform.

Waveform data is stored in nonvolatile memory and is retained when input power is removed. Up to 50 user-defined waveforms may be created and stored per group. The *RST and *RCL commands have no effect on user-defined waveforms. Be careful when using the *RCL command to make sure the waveform group that was selected when the front panel setup was stored is the same. If not, the AC/DC power source will attempt to recall a waveform that likely does not exist in the presently selected group of waveforms. In this case, an error message is generated and no switching of the waveform at the output of the source takes place.

A waveform can be selected for output using the FUNCtion:SHAPE, FUNCtion:SHAPE:TRIGgered, or LIST:SHAPE commands.

Command Syntax:	TRACe[:DATA]<waveform_name>,<NRf> {,<NRf>}
Parameters	<waveform_name>, <amplitude>
Example	TRAC flattop,0.1,0.3,0.7,.....-0.7,-0.3,-0.1
Query Syntax:	none
Related Commands	TRAC:DATA TRAC:DEL FUNC:SHAP

TRACe:CATalog

These commands return a list of defined waveform names. The list includes both pre-defined waveforms such as SINusoid, SQUare, and CSINusoid, as well as any user-defined waveforms.

Query Syntax:	TRACe:CATalog?		
Returned Parameters	<SRD>		
Example	TRAC:CAT?		
Related Commands	TRAC:DATA	TRAC:DEL	FUNC:SHAP

TRACe:DEFine

These commands define a new waveform with the name <waveform_name> and allocates storage for its data. The waveform name can then be referenced by the TRACe:DATA.

Note: *The TRAC:DEF command causes waveform catalog data to be writing to the Flash memory of the unit. This process requires about 500 msec to complete. The TRAC:DATA command which normally follows should not be sent during this period to allow this process to complete or the first part of the data may be missed and an error will result.*

Command Syntax:	TRACe:DEFine <waveform_name>		
Parameters	<waveform_name>		
Example	TRAC:DEF flattop		
Related Commands	TRAC:DATA	TRAC:DEL	FUNC:SHAP

TRACe:DELeTe

This command deletes the user-defined waveform table with the name <waveform_name> and makes its memory available for other waveforms.

Command Syntax:	TRACe:DELeTe[:NAME]<waveform_name>		
Parameters	<waveform name>		
Example	TRAC:DEL flattop		
Related Commands	TRAC:DATA	TRAC:DEL	FUNC:SHAP

TRACe:DELeTe

This command deletes **ALL** user-defined waveforms at once and makes all waveform memory available for other waveforms. This command is only supported by firmware revisions 0.16 and higher.

Command Syntax:	TRACe:DELeTe:ALL		
Parameters	<waveform name>		
Example	TRAC:DEL:ALL		
Related Commands	TRAC:DATA	TRAC:DEL	FUNC:SHAP

4.26 Trigger Subsystem

This subsystem controls the triggering of the AC/DC power source. See chapter 6 under "Triggering Output Changes" for an explanation of the Trigger Subsystem. The INITiate commands control the initialization of the transient system. The trigger subsystem must first be enabled using the INITiate commands or no triggering action will occur. Refer to Figure 6-5 for a block diagram of the trigger system.

Subsystem Syntax

ABORt Resets the trigger system to the Idle state

INITiate

[:IMMediate]	Initiates the system for one trigger
[:TRANsient]	
:ACQuire	
:CONTInuous	sets if the initiate continuous to (ON OFF)
TRIGger	
[:TRANsient]	
:SOURce	Sets the trigger source (IMMediate BUS EXT)
:COUNT	Set if the trigger is controlled at every count(NONE ALL)
:ACQuire	
:SOURce	set the aquire trigger soure (IMMediate SYNChronize BUS TTLTrg)
:SYNChronize	
:SOURce <source>	Sets the trigger sync source (IMM PHAS)
:PHASe <n>	Sets the synchronous phase reference
:STATe?	Return the trigger state (IDLE ARM BUSY)

ABORt

This command resets the transient trigger systems to the Idle state. Any output transient or measurement that is in progress is immediately aborted. ABORt also cancels any lists or pulses that may be in process.

Command Syntax	ABORt
Parameters	one
Examples	ABOR
Related Commands	INIT *RST *TRG

INITiate[:IMMEDIATE][:TRANSient]

The INITiate command controls the initiation of the transient generation or measurement acquisition trigger system. They cause the trigger system to make a transition from the Idle state to the Waiting-for-Trigger state. If the trigger system is not in the Idle state, the initiate commands are ignored.

If both the transient generation and the measurement acquisition trigger systems are initiated at the same time, the first trigger event that occurs will trigger the measurement system. The transient system will trigger on the next trigger event. Thus, the measurement system has a higher trigger priority than the transient system. If the measurement trigger is generated by a transient event, the acquisition system should be initiated first so it is waiting for the trigger caused by the transient system.

Command Syntax	INITiate[:IMMEDIATE][:TRANSient]
Parameters	None
Examples	INIT
Related Commands	ABOR INIT:CONT *TRIG

INITiate:ACquire**[Pi Controller Only]**

The INITiate:ACquire command controls the initiation of the measurements trigger system. They cause the trigger system to make a measurement from the Idle state to the Waiting-for-Trigger state. If the trigger system is not in the Idle state, the initiate commands are ignored.

Command Syntax	INITiate:ACquire
Parameters	None
Examples	INIT:ACQ
Related Commands	ABOR INIT:CONT *TRIG

INITiate:CONTinuous

These commands control the transient generator trigger system.

- 1 or ON continuously initiates the transient trigger system.
- 0 or OFF turns off continuous triggering. In this state, the trigger system must be initiated for each triggered event using INITiate:TRANSient.

Command Syntax	INITiate:CONTinuous
Parameters	0 1 OFF ON
*RST Value	OFF
Examples	INIT:CONT ON
Related Commands	ABOR INIT:CONT *TRG

TRIGger[:TRANSient]:SOURce

This command will determine the source of the trigger event for the transient. The following sources are available:

- **IMMEDIATE** Triggering occurs as soon as the INIT command is received.
- **BUS** Triggering occurs following the INIT command after receiving the *TRG command or a Group Execute Trigger (GET) IEEE signal.
- **EXTERNAL** Triggering occurs when an external trigger input is received.

Command Syntax	TRIGger[:TRANSient]:SOURce
Parameters	IMMEDIATE BUS EXT
*RST Value	IMMEDIATE
Examples	TRIG:SOUR BUS
Related Commands	ABOR <group execute trigger>

TRIGger:COUNT

This command determines whether the phase synchronization is accomplished at the beginning of the transient list or pulse for every COUNT or at the beginning of the transient for the first count only. It accepts the following parameters.

- **NONE** Synchronization is accomplished once
- **ALL** Synchronization is accomplished for every count.

Command Syntax	TRIGger:COUNT ALL TRIGger:COUNT NONE
Parameters	ALL, NONE
*RST Value	NONE
Examples	TRIG:COUN ALL TRIG:COUN NONE
Query Syntax	TRIG:COUN?
Returned Parameters	<CRD>
Related Commands	ABOR TRIG TRIG:DEL TRIG:SYNC TRIG:SYNC:PHAS INIT INIT:CONT *TRG WAI

TRIGger:ACQuire:SOURce**[3Pi Controller Only]**

These commands select the trigger source for a triggered measurement sequence as follows:

IMMEDIATE	Acquire the measurements immediate. The FETCh commands return the requested calculation from the set of acquired data as soon as the measurement calculations are completed by the controller.
SYNChronize	Internal phase A angle
BUS	IEEE-488 device, *TRG, or <GET> (Group Execute Trigger)
TTLTrg	The signal driving the Trigger Out BNC

Command Syntax	TRIGger:ACQuire:SOURce<CRD>		
Parameters	IMM SYNC BUS TTLT		
*RST Value	IMM		
Examples	TRIG:ACQ:SOUR BUS		
Query Syntax	TRIGger:ACQuire:SOURce?		
Returned Parameters	<CRD>		
Related Commands	ABOR	TRIG:SOUR	TRIG:SYNC:SOUR TRIG:SYNC:PHAS INIT INIT:CONT *TRG

TRIGger:SYNChronize:SOURce

This command selects the synchronizing trigger source in generating a step, pulse, or list output as follows:

- IMMEDIATE starts the transient output immediately.
- PHASe starts the transient output at the reference phase set by TRIG:PHAS.

Command Syntax	TRIGger:SYNChronize:SOURce <CRD>		
Parameters	IMMEDIATE PHASe		
*RST Value	IMM		
Examples	TRIG:SYNC:SOUR IMM	TRIG:SOUR PHAS	
Query Syntax	TRIGger:SYNChronize:SOURce?		
Returned Parameters	<CRD>		
Related Commands	ABOR	TRIG:SYNC:PHAS	INIT INIT:CONT *TRG

TRIGger:SYNChronize:PHASe

This command sets the phase angle with respect to an internal phase reference if TRIGger:SOURce PHASe is selected. The range is from -360 to +360 Degrees.

Command Syntax	TRIGger:SYNChronize:PHASe<NRf+>		
Parameters	360 to +360		
*RST Value	0		
Examples	TRIG:SYNC:PHAS 90		
Query Syntax	TRIGger:SYNChronize:PHASe?		
Returned Parameters	<NR2>		
Related Commands	ABOR	TRIG:SYNC:SOUR	INIT INIT:CONT *TRG

TRIG:STATe?

This is a query only command. The response will define the state of the transient trigger system as follows:

- IDLE The trigger is in the idle state.
- ARM The trigger is waiting for internal synchronization or external trigger
- BUSY The triggered transient is in progress.
- WTRIG The unit is waiting for a trigger event.

The trigger state will be updated when the last list point has been executed. For final voltage or frequency steps with a longer dwell time than needed to reach the end value, this means the response may change from BUSY to IDLE before the dwell time has expired. If this affects the application program, it will be necessary to add a final list point with a short duration (e.g. 0.001 second) to hold the BUSY state till the end of the list.

Note: Firmware revision 0.31 or lower will respond with “ARM” instead of “IDLE” at the end of transient execution even if the trigger mode is immediate.

Query Syntax	TRIGger:STATe?
Returned Parameters	<CRD>
Related Commands	ABOR TRIG:SOUR TRIG:PHAS INIT INIT:CONT *TRG

5. Common Commands

Common commands begin with an * and consist of three letters (command) or three letters and a ? (query). Common commands are defined by the IEEE 488.2 standard to perform some common interface functions. The AC/DC power source responds to the required common commands that control status reporting, synchronization, and internal operations. It also responds to optional common commands that control triggers, and stored operating parameters.

Common commands and queries are listed alphabetically. If a command has a corresponding query that simply returns the data or status specified by the command, then both command and query are included under the explanation for the command. If a query does not have a corresponding command or is functionally different from the command, then the query is listed separately. The description for each common command or query specifies any status registers affected. Refer to chapter 7 for details on how to read specific register bits and use the information that they return.

Common Commands Syntax

*CLS	Clear status
*ESE <n>	Standard event status enable
*ESE?	Return standard event status enable
*ESR?	Return event status register
*IDN?	Return instrument identification
*OPC 1	Enable "operation complete" bit in ESR
*OPC?	Return a "1" when operation complete
*OPT?	Return option number
*PSC <bool>	Power-on status clear state set/reset
*PSC?	Return power-on status clear state
*RCL <n>	Recall instrument state
*RST	Reset
*SAV <n>	Save instrument state
*SRE <n>	Set service request enable register
*SRE?	Return service request enable register
*STB?	Return status byte
*TRG	Trigger
*WAI	Hold off bus until all device commands done

5.1 *CLS

This command clears the following registers (see chapter 7 for descriptions of all status registers):

- Standard Event Status
- Operation Status Event
- Questionable Status Event
- Status Byte
- Error Queue

Command Syntax	*CLS
Parameters	None

5.2 *ESE

This command programs the Standard Event Status Enable register bits. The programming determines which events of the Standard Event Status Event register (see *ESR?) are allowed to set the ESB (Event Summary Bit) of the Status Byte register. A "1" in the bit position enables the corresponding event. All of the enabled events of the Standard Event Status Event Register are logically ORed to cause the Event Summary Bit (ESB) of the Status Byte Register to be set. See section 5.3 for descriptions of the Standard Event Status registers.

The query reads the Standard Event Status Enable register.

Bit Configuration of Standard Event Status Enable Register

Bit Position	7	6	5	4	3	2	1	0
Bit Name	PON	not used	CME	EXE	DDE	QYE	not used	OPC
Bit Weight	128		32	16	8	4		1

CME	Command error	DDE	Device-dependent error
EXE	Execution error	OPC	Operation complete
PON	Power-on	QYE	Query error

Command Syntax	*ESE <NRf>
Parameters	0 - 255
Power-On Value	0 (see *PSC command)
Example	*ESE 129
Query Syntax	*ESE?
Returned Parameters	<NR1>(Register value)
Related Commands	*ESR? *STB?

5.3 *ESR?

This query reads the Standard Event Status Event register. Reading the register clears it. The bit configuration of this register is the same as the Standard Event Status Enable register (see *ESE). See chapter 7 for a detailed explanation of this register.

Query Syntax	*ESR?
Parameters	None
Returned Parameters	<NR1>(Register value)
Related Commands	*CLS *ESE *ESE? *OPC

5.4 *IDN?

This query requests the source to identify itself. It returns the data in four fields separated by commas.

Query Syntax	*IDN?	
Returned Parameters	<AARD>	
	Field	Information
	California Instruments	Manufacturer
	xxxxxx	Model number and letter
	nnnnnn	Serial number or 0
	Rev. xx.xx	Revision level of firmware
Example	"CALIFORNIA INSTRUMENTS,CSW5550, 12345, Rev 4.0"	

5.5 *OPC

This command causes the interface to set the OPC bit (bit 0) of the Standard Event Status register when the source has completed all pending operations. (See *ESE for the bit configuration of the Standard Event Status registers.)

Pending operations are complete when all commands sent before *OPC have been executed. This includes overlapped commands. Most commands are sequential and are completed before the next command is executed. Overlapped commands are executed in parallel with other commands. Commands such as measurement and calibration are overlapped with subsequent commands sent to the AC/DC power source. The *OPC command provides notification that all overlapped commands have been completed.

*OPC does not prevent processing of subsequent commands but Bit 0 will not be set until all pending operations are completed. The *OPC 1 command must be part of the same message with the command for which the OPC status is requested.

The query causes the interface to place an ASCII "1" in the Output Queue when all pending operations are completed.

Command Syntax	*OPC <NR1>
Parameters	1
Query Syntax	*OPC?
Returned Parameters	<NR1>
Related Commands	*TRIG *WAI

5.6 *OPT?

This query requests the AC source to identify any options that are installed. Options are identified by a string keyword or a number. A 0 anywhere in this list indicates that specific feature is not installed. If a feature is installed or available, its corresponding keyword will be returned. Refer also to the SYSTem:CONFigure[:BYTE] command. This command only has a query format as these settings cannot be changed.

Query Syntax	*OPT?
Returned Parameters	<CRD>,[<CRD>]

The parameter list returned and their order in the sequence is shown in the table below.

Syntax	Description	Comment
SCPI	SCPI language	This feature is always enabled on CSW Series models.
NOUT	MODE option	Phase mode selection. Available only on CSW30/CSW45-3Pi systems.
ADV	Advanced Features	Available on CSW Series models with –3Pi controllers only.
CLK/LOC	Clock and Lock mode	Allows multiple controllers to be synced.
DO160	Option –160	RTCA/DO160 test option.
MIL704D	Option –704	MIL-STD704 test option.
IEC411	Option -411	IEC61000-4-11 voltage dips and interruptions test option. This option must be installed to support the EOS1 or EOS3.
IEC413	Option -413	IEC61000-4-13 Interharmonics test option.
WHM	Option –WHM	Supported only on i/iX Series with firmware CIC463-5.
ABD ¹	Option –ABD	Airbus ABD0100.1.8 test option. Requires use of CSWGui Windows software.
LF ²	Option –LF	Limits interharmonics generator direct control output to 500 Hz maximum.
MB ³	Option –MB	Allows System field setting in Configuration menu to be changed to support different configurations.
OPT2 ⁴	Option –B787	Boeing B787-0147 test option. Requires use of CSWGui Windows software.

¹ Note: *OPT? response list will not have “ABD” field if firmware revision is less than 1.13

² Note: *OPT? response list will not have “LF” field if firmware revision is less than 1.14.

³ Note: *OPT? response list will not have “MB” field if firmware revision is less than 4.00 (CSW15 excluded)

⁴ Note: *OPT? response list will not have “OPT2” field if firmware revision is less than 4.00 (CSW15 excluded).

Syntax	Description	Comment
OPT1 ¹	Option –AMD	Airbus AMD24C test option. Requires use of CSWGui Windows software.

¹ Note: *OPT? response list will not have “OPT1” field if firmware revision is less than 4.00 (CSW15 excluded).

5.7 *PSC

This command controls the automatic clearing at power-on of the Service Request Enable and the Standard Event Status Enable registers (see chapter 7 under 7.6.2 for register details):

*PSC ON 1	Prevents the register contents from being saved causing them to be cleared at power-on. This prevents a PON event from generating a SRQ at power-on.
PSC OFF 0	Saves the contents of the Standard Event Enable and Service Request Enable registers in nonvolatile memory and recalls them at power-on. This allows a PON event to generate SRQ at power-on. Using the PCS command in this mode allows the control program to detect a power failure condition that caused the source to power down and back up again.

Command Syntax	*PSC<bool>
Parameters	0 1 OFF ON
Example	*PSC 0 *PSC 1
Query Syntax	*PSC?
Returned Parameters	0 1
Related Commands	*ESE *SRE

5.8 *RCL

This command restores the AC/DC source to a state that was previously stored in memory (including the transient list) with a *SAV command to the specified location. All states are recalled with the following exceptions:

- CAL:STATE is set to OFF
- The trigger system is set to the Idle state by an implied ABORT command (this cancels any uncompleted trigger actions)

Command Syntax	*RCL <NRf>
Parameters	0 through 7
Example	*RCL 3
Related Commands	*RST *SAV

WARNING: *Recalling a previously stored state may place hazardous voltages at the AC source output.*

5.9 *RST

The reset (*RST) command has the same effect as an IEEE-488 Device Clear bus command but can be used over the RS232C interface as well. This command resets the AC source to the following factory-defined states:

Table 5-1 : *RST default parameter values

Item	Value	Item	Value
INIT:CONT	OFF	[SOUR:]LIST:STEP	AUTO
OUT	OFF	[SOUR:]PHAS:MODE	FIX
OUTP:TTLT	OFF		
OUTP:TTLT:SOUR	BOT		
[SOUR:]CURRE:PROT:DEL	100ms	[SOUR:]VOLT:TRIG	
[SOUR:]FREQ:MODE	FIX	[SOUR:]VOLT:SLEW:MODE	FIX
[SOUR:]FREQ:SLEW	MAX	[SOUR:]VOLT:SLEW:TRIG	MAX
[SOUR:]FREQ:SLEW:MODE	FIX	TRIG:CONN	NONE
[SOUR:]FREQ:SLEW:TRIG	MAX		
[SOUR:]FREQ:TRIG	60Hz	TRIG:SYNC:SOUR	IMM
[SOUR:]FUNC:MODE	FIX	TRIG:SYNC:PHAS	0
		TRIG:SOUR	IMM

Command Syntax	*RST
Parameters	None
Related Commands	*SAV

A *RST command or a IEEE-488 Device Clear also clears all status registers but does not change the Event Enable registers for each status register group.

Application note:

When using the *RST command on systems set to power up in single phase mode, it will be necessary to momentarily change the power on selection to three phase mode to ensure all three phases are re-initialized. This can be done with the following code sequence:

```

PONS:NOUT? // Determine current PONS phase setting.
<response>
PONS:NOUT THR // Set to three phase initialization
*RST // Issue reset command.
Delay 500msec // allow time to reset system.
If <response> <> THR Then // Set back if needed
    PONS:NOUT <response>
End if

```

5.10 *SAV

This command stores the present state of the AC/DC power source to a specified location in memory. Up to 8 states (including the transient list) can be stored in nonvolatile memory.

Command Syntax	*SAV
Parameters	0 through 7
Related Commands	PSC *RCL *RST

5.11 *SRE

This command sets the condition of the Service Request Enable Register. This register determines which bits from the Status Byte Register (see *STB for its bit configuration) are allowed to set the Master Status Summary (MSS) bit and the Request for Service (RQS) summary bit. A 1 in any Service Request Enable Register bit position enables the corresponding Status Byte Register bit and all such enabled bits then are logically ORed to cause Bit 6 of the Status Byte Register to be set. See paragraph 7.5 for more details concerning this process.

When the IEEE-488 BUS controller conducts a serial poll in response to SRQ, the RQS bit is cleared, but the MSS bit is not. When *SRE is cleared (by programming it with 0), the source cannot generate an SRQ to the controller.

Command Syntax	*SRE <NRf>
Parameters	0 to 255
Default Value	0 (see *PSC command)
Example	*SRE 255
Query Syntax	*SRE?
Returned Parameters	<NR1>(Register binary value)
Related Commands	*ESE *ESR

5.12 *STB?

This query reads the Status Byte register, which contains the status summary bits and the Output Queue MAV bit. Reading the Status Byte register does not clear it. The input summary bits are cleared when the appropriate event registers are read (see chapter 7 for more information). A serial poll also returns the value of the Status Byte register, except that bit 6 returns Request for Service (RQS) instead of Master Status Summary (MSS). A serial poll clears RQS, but not MSS. When MSS is set, it indicates that the source has one or more reasons for requesting service.

Bit Configuration of Status Byte Register

Bit Position	7	6	5	4	3	2 - 0
Bit Name	OPER	MSS RQS	ESB	MAV	QUES	not used
Bit Weight	128	64	32	16	8	

OPER	operation status summary	MSS	master status summary
ESB	event status byte summary	RQS	request for service
QUES	questionable status summary	MAV	message available

Query Syntax	*STB?
Returned Parameters	<NR1> (Register binary value)
Related Commands	*SRE *ESE *ESR

5.13 *TRG

This command generates a trigger to any subsystem that has BUS selected as its source (for example, TRIG:SOUR BUS). The command has the same effect as the Group Execute Trigger (<GET>) command.

Command Syntax	*TRG
Parameters	None
Related Commands	ABOR INIT

5.14 *WAI

This command instructs the AC/DC source not to process any further commands until all pending measurement and calibration operations are completed. Pending operations are complete when all commands sent before *WAI have been executed. This includes overlapped commands. Most commands are sequential and are completed before the next command is executed. Overlapped commands are executed in parallel with other commands. Commands that affect output voltage or state, relays, and trigger actions are overlapped with subsequent commands sent to the AC source. The *WAI command prevents subsequent commands from being executed before any overlapped commands have been completed.

The *WAI command may be used when performing measurement queries (MEAS or FETCh) to force the AC/DC source to respond to the query before processing any subsequent command.

*WAI can be aborted by sending any other command after the *WAI command.

Command Syntax	*WAI
Parameters	None
Related Commands	*OPC

6. Programming Examples

6.1 Introduction

This chapter contains examples on how to program the AC/DC source. Simple examples show you how to program:

- Output functions such as voltage, frequency, and phase
- The transient waveform generator
- Internal and external triggers
- Measurement functions
- User-defined waveforms
- The status and protection functions

The examples in this chapter use generic SCPI commands. See chapter 2 for information about encoding the commands as language strings. Where appropriate, optional commands are shown for clarity in the examples.

6.2 Programming the Output

6.2.1 Power-on Initialization

When the AC source is first turned on, it wakes up with the output state defined by the PONSetup. In this state the output voltage is set to a value defined by the INIT:VOLT. The following commands are given implicitly at power-on:

```
*RST
*CLS
*SRE 0
*ESE 0
```

*RST is a convenient way to program all parameters to a known state. Refer to Table 5-1 under the *RST command in paragraph 5.9 to see how each programmable parameter is set by *RST. Refer to the *PSC command in chapter 0 for more information on the power-on initialization of the *ESE and the *SRE registers.

6.2.2 Enabling the Output

To enable the output, use the command:

```
OUTPut ON
```

6.2.3 AC Voltage and Frequency

The AC rms output voltage is controlled with the VOLTage command. For example, to set the AC output voltage to 125 volts rms, use:

```
MODE AC
VOLTage 125
```

The DC output voltage is controlled with the VOLTage:DC command. For example, to set the DC output voltage to 100 volts DC, use:

```
MODE DC
VOLTage:DC 100
```

The AC/DC power source can be programmed to turn off its output if the actual output voltage does not agree within a given tolerance with the set value using the measurement query command.

Maximum Voltage

The maximum rms output voltage that can be programmed can be queried with:

```
VOLTage? MAX
```

The maximum voltage that the AC/DC source can output is limited by the maximum peak voltage capability of the AC/DC source. This value is expressed in the equivalent rms value of a sinewave (crest factor = 1.414). The maximum rms value is defined by the LIMIT subsystem. If a custom waveform is selected with a crest factor higher than 1.414, the maximum rms voltage will be less than the LIMIT value.

Voltage Ranges

The power source has two voltage ranges that are controlled by relays. The command that controls the range is:

```
VOLTage:RANGe MIN | MAX | 156 | 312
```

When the range is set to MIN (156), the maximum rms voltage that can be programmed for a sine wave is 156 volts rms, but it is only on this range that the maximum output current rating is available.

The VOLTage:RANGe command is coupled with the CURRent command. This means that the maximum current limit that can be programmed at a given time depends on the voltage range setting in which the unit is presently operating.

Frequency

The output frequency is controlled with the FREQuency command. To set the output frequency to 50 Hz, use:

```
FREQuency 50
```

6.2.4 Voltage and Frequency Slew Rates

Voltage Slew

The AC source has the ability to control the slew rate of AC amplitude and frequency changes and DC amplitude. This can be used to generate ramps or to protect sensitive loads. To set the voltage slew rate to 20 volts per second, use:

```
VOLTage:SLEW 20
```

At *RST the slew rate is set to Maximum, which means that AC voltage changes occur at the fastest possible slew rate. The slew rate applies to programmed changes in AC/DC output amplitude while the unit is operating in fixed mode. Amplitude changes made by the step, pulse, and list transients are controlled by the same rules that apply to all other functions that are subject to transient control. See section 6.4.

Frequency Slew

The AC source also has the ability to control the slew rate of frequency changes. To set the frequency slew rate to 30 Hz per second, use:

```
FREQuency:SLEW 30
```

At *RST the slew rate is set to MAXimum, which means that frequency changes occur instantaneously. The frequency slew rate applies to programmed changes in frequency while the unit is operating in fixed mode. Frequency changes made by the step, pulse, and list transients are controlled by the same rules that apply to all other functions that are subject to transient control. See section 6.4.

6.2.5 Programming the Output Phase

You can control the phase of the AC voltage waveform relative to an external reference with:

```
PHASe <n>
```

which sets the phase in degrees. If <n> is positive, the voltage waveform leads the internal reference or phase A value in three phase configuration.

Note: *For three phase clock and lock configurations, the PHASe command sets the relative phase of B and C with respect to phase A.*

6.2.6 Current Limit

This command will set the rms current limit, to set this limit is:

```
CURRent <n>
```

where <n> is the rms current limit in amperes.

If the load attempts to draw more current than the programmed limit, and the source is set for constant current mode, the output voltage is reduced to keep the rms current within the limit. Since the rms detection involves a filter time constant that is long compared to a single output cycle, the response time of the rms current limit is not instantaneous.

The AC source can be programmed to turn off its output if the rms current limit is reached. This protection feature is activated when the source mode is set for constant voltage mode.

Note: *The CURRent command is coupled with the VOLTage:RANGe. This means that the maximum current limit that can be programmed at a given time depends on the voltage range setting in which the unit is presently operating. Refer to "Coupled Commands" for more information.*

6.2.7 Waveform Shapes

At *RST, the AC/DC power source generates a sine waveform when in AC or AC+DC mode, but other shapes can be selected. There are built-in tables for sine, square and clipped sine waveforms. In addition, the user can define arbitrary waveshapes by creating a 1024 point table of amplitudes for a single cycle.

As shown in the following examples, the FUNCtion[:SHAPE] command selects the output waveform.

Square Waveform

To select the square output waveform, use:

```
FUNcTion:SHAPE SQUare
```

Clipped Waveform

To select a clipped sine waveform use:

```
FUNcTion:SHAPE CSINe
```

To set the clipping level to 10% THD, use:

```
FUNcTion:SHAPE:CSINe 10
```

The clipping level is specified in terms of the percent total harmonic distortion in the clipped sine waveform.

User-Defined Waveform

To create a user-defined waveform, use TRACe:DEFine command to create a name for the waveform, then use the TRACe[:DATA] command to send the list of 1024 amplitude points. The waveform can then be selected using the FUNCtion command. For example, a waveform named "Distortion" can be created with:

```
TRACe:DEFine DISTORTION  
TRACe:DATA DISTORTION, n1, n2, n3, ..., n1024
```

where n1 ... n1024 are the data points that define the relative amplitudes of exactly one cycle of the waveform. The first data point defines the amplitude that will be output at 0 degrees phase reference.

Data points can be in any arbitrary units. The AC source scales the data to an internal format that ensures that the correct ac rms voltage is output when the waveform is selected. When queried, trace data is returned as normalized values in the range of ± 1 . Waveform data is stored in nonvolatile memory and is retained when input power is removed. Up to 50 user defined waveforms may be created and stored in one of 4 separate groups.

Because waveform shape commands are coupled with the voltage commands, changing waveforms without changing the programmed voltage may result in an error if the resulting peak voltage amplitude exceeds the maximum voltage rating of the AC/DC power source. Refer to "Coupled Commands" for more information.

6.2.8 Individual Phases

On three phase models or configurations, the following functions can be controlled separately on each phase:

- VOLTage
- CURRent
- PHASe
- FUNCTion
- MEASure
- FETCh
- CALibration

Selecting a Phase

Two commands determine which output phase or phases receive commands in the three phase mode. These are:

```
INSTRument:COUPlE ALL | NONE
INSTRument:NSElect <n>
```

The *RST setting for INSTRument:COUPlE is NONE. This setting causes programming commands to be sent to the selected output phases only.

To send a programming command to all of the output phases, set INSTRument:COUPlE to ALL. For individual phase programming use ALL, then select the desired output to receive the command with INSTRument:NSElect. For example, when the commands

```
INSTRument:COUPlE NONE
INSTRument:NSElect 2
```

are sent, all subsequent voltage commands will go to output phase 2, and all measurement queries will return readings from output phase 2.

Note: *The INSTRument:COUPlE command has no effect on queries. In the three-phase mode, queries are always directed to the output selected by INSTRument:NSElect.*

Programming the Output Phase

You can control the phase of the ac voltage waveform relative to an internal reference or to phase A with:

```
PHASe <n>
```

which sets the phase in degrees. If <n> is positive, the voltage waveform leads the internal reference.

The INSTRument:COUPlE setting is ignored by the PHASe command - it always controls the output selected by INSTRument:NSElect.

6.3 Coupled Commands

This section describes how to avoid programming errors that may be caused by the error checking done for coupled commands such as `VOLTage:LEVel`.

Commands that are coupled to the `VOLTage` command are the output transient commands that control step, pulse and list generation. When an output transient is initiated (ready to receive a trigger), the error checking that takes place for maximum rms voltage.

```
CURRent:LEVel and VOLTage:RANGe
```

Programming the current limit by itself to a value that is greater than the maximum allowed on the presently programmed voltage range causes an error. If the commands

```
VOLTage:RANGe 312
```

```
CURRent 90
```

are sent, an error will be generated because the `CURRent` command is requesting a current limit that is outside the maximum value allowed on that voltage range.

Programming the `VOLTage:RANGe` by itself causes the programmed current limit to be set to the maximum for the given range if it had previously been higher than the maximum setting for the new range. If the commands

```
VOLTage:RANGe 156
```

```
CURRent 16
```

```
VOLTage:RANGe 312
```

are sent, no error will be generated because the second `VOLTage:RANGe` command automatically sets the programmed current limit to 8.0, which is the maximum value for the programmed voltage range.

Programming both the current and the voltage range in one program message unit can be done based on the order and the initial voltage setting. If the following commands are sent:

```
VOLTage:RANGe 312
```

```
CURRent 8.0;:VOLTage:RANGe 156;:CURRent 16
```

no error will be generated because the combined current limit and voltage range specified on the second line are within the output ratings of the power source, but the voltage range command must be sent before the current command.

6.4 Programming Output Transients

Output transients are used to:

- Synchronize output changes with a particular phase of the voltage waveform.
- Synchronize output changes with internal or external trigger signals.
- Simulate surge, sag, and dropout conditions with precise control of duration and phase.
- Create complex, multi-level sequences of output changes.
- Create output changes that have rapid or precise timing requirements.

The following AC/DC source functions are subject to transient control:

- AC output voltage
- DC output voltage
- Frequency
- Start phase angle
- AC/DC voltage slew rate
- Frequency slew rate

The following transient modes can be generated:

Step	generates a single triggered output change.
Pulse	generates an output change which returns to its original state after some time period.
List	generates a sequence of output changes, each with an associated dwell time or paced by triggers.
Fixed	turns off the transient functions, which means that only the IMMEDIATE values are used as the data source for a particular function.

After a *RST or Device Clear command, all functions are set to FIXEd, which turns off the transient functions.

6.4.1 Transient System Model

Figure 6-1 shows a model of the transient system. The figure shows the transient modes and the output waveform that is generated in each mode.

When a trigger is received in step or pulse modes, the triggered functions are set from their IMMEDIATE to their TRIGGERED value. In Step mode, the triggered value becomes the immediate value. In Pulse mode, the functions return to their immediate value during the low portion of the pulse.

If there are no further pulses, the immediate value remains in effect. In List mode, the functions remain at the last list value at the completion of the list.

You can not mix STEP, PULSE, and LIST modes among functions.

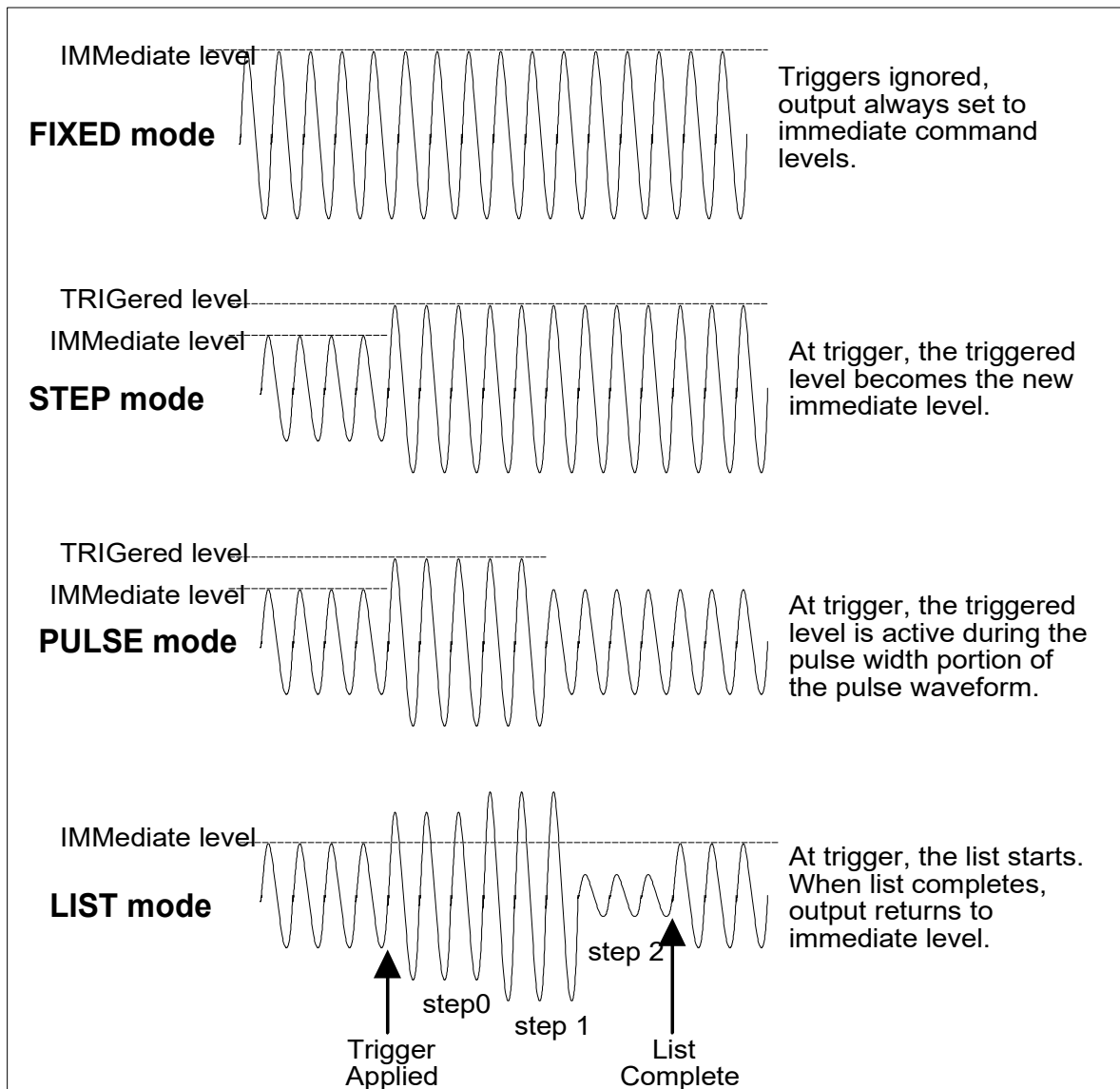

Figure 6-1: Output transient system

6.4.2 Step and Pulse Transients

Step 1 : Set the functions that you do not want to generate transients to FIXEd mode. A convenient way to do this is with the *RST command. Then set the mode of the function that will generate the transient to STEP or PULSe as required. For example, to enable the voltage function to generate a single triggered output voltage change, use:

```
*RST
VOLTage:MODE STEP
```

Step 2 : Set the triggered level of the function that will generate the transient. For example, if the previously programmed voltage function is going to step the output voltage amplitude to 135 volts upon receipt of a trigger, use:

```
VOLTage:TRIGger 135
```

Step 3 : Select the trigger source that will generate the trigger. For example, to select the Immediate use:

```
TRIGger:SOURce IMM
```

Trigger sources are discussed in detail under “Triggering Output Changes”

Step 4 : Only perform this step if you have selected PULSE as the transient mode in Step 1. Specify the pulse count, the pulse period, and then either the duty cycle or the pulse width using the following commands:

PULSe:COUNT 1	specifies 1 output pulse
PULSe:PERiod 1	specifies a pulse period of 1 second
PULSe:DCYCLE 50	specifies a duty cycle of 50%
PULSe:WIDTh .5	specifies a pulse width of .5 seconds (not necessary in this case since a duty cycle has already been specified)

Step 5 : Initiate the transient trigger system to enable it to receive a trigger. To enable the trigger system for one transient event use:

```
INITiate
```

Example

The following example programs a voltage dropout for 2 cycles of a 120 volt, 60 Hz output. The dropout begins at the positive peak of the output voltage waveform (90 degrees phase) and is triggered by IEEE-488 bus trigger.

*RST	Begin at power-on state
VOLT 120	Set initial output voltage (immediate-level)
FREQ 60	Set initial output frequency
OUTP ON	Enable the output
VOLT:MODE PULS	Enable output to generate pulses when triggered
VOLT:TRIG 0	Set the voltage dropout (triggered level)
PULS:WIDT .03333	Set pulse width for 2 periods
PULS:PER 0.0667	Set pulse period for 4 cycles
TRIG:SOUR BUS	Respond to IEEE-488 bus triggers
TRIG:SYNC:SOUR:PHAS	Synchronize triggers to internal phase reference
TRIG:SYNC:PHAS 90	Sets internal phase reference point to 90 degrees
INIT	Set to Wait-for-trigger state
<device trigger>	Send the IEEE-488 bus trigger

6.4.3 List Transients

List mode lets you generate complex sequences of output changes with rapid, precise timing, which may be synchronized with internal or external signals. Each function that can participate in output transients can also have an associated list of values that specify its output at each list point.

You can program up to 32 settings (or points) in the list, the time interval (dwell) that each setting is maintained, the number of times each data point is repeated, the number of times that the list will be executed, and how the settings change in response to triggers.

All list point data can be stored in nonvolatile memory using one of the available setup register. This means that the programmed data for any list function will be retained when it is saved in the register when the AC source is turned off.

Note: *If the transient list is programmed over the bus, the transient must be executed at least once or it will not be saved to the setup register when the *SAV command is sent. Unexecuted transient lists have not been compiled yet by the AC/DC power source controller and will not be saved as part of a front panel setup. This is not the case when the transient list is entered from the front panel. Front panel entered transient lists will be saved even if they have not been executed yet.*

Lists are paced by a separate list of dwell times which define the duration of each output setting. Therefore, each of the up to 32 list points has an associated dwell time, which specifies the time (in seconds) that the output remain at that setting before moving on to the next setting.

The following procedure shows how to generate a simple list of voltage and frequency changes.

Step 1 : Set the mode of each function that will participate in the output sequence to LIST. For example:

```
VOLTage:MODE LIST
FREQuency:MODE LIST
```

Step 2 : Program the list of output values for each function. The list commands take a comma-separated list of arguments. The order in which the arguments are given determines the sequence in which the values will be output. For example, to cycle the voltage through a sequence that includes nominal line, high line, and low line, a list may include the following values:

```
LIST:VOLTage 135, 100, 120, 135, 100, 128, 110, 102, 132, 112
```

You can specify lists for more than one function. For example, to synchronize the previous voltage list with another list that varies the output frequency from nominal, to high, to low, the lists may include the following values:

```
LIST:VOLTage 135, 100, 120, 135, 100, 128, 110, 102, 132, 112
LIST:FREQuency 60, 60, 60, 63, 63, 63, 57, 57, 57, 60
```

All lists must have the same number of data values or points, or an error will occur when the transient system that starts the sequence is later initiated. The exception is when a list has only one item or point. In this case the single-item list is treated as if it had the same number of points as the other lists, with all values being equal to the one item. For example:

```
LIST:VOLTage 120, 100, 110;FREQuency 60
```

is the same as:

```
LIST:VOLTage 120, 100, 110
```



```
LIST:FREQuency 60, 60, 60
```

Step 3 : Determine the time interval that the output remains at each level or point in the list before it advances to the next point. The time is specified in seconds. For example, to specify five dwell intervals, use:

```
LIST:DWELL 1, 3.5, 1.5, 0.5, 3.8, 1.2
```

The number of dwell points must equal the number of output points. If a dwell list has only one value, that value will be applied to all points in the output list.

Step 4 : Determine the number of times the list is executed before it completes. For example, to run a list 10 times use:

```
LIST:COUNt 10
```

At *RST, the count is set to 1.

Step 5 : Determines how the list sequencing responds to triggers. For a closely controlled sequence of output levels, you can use a dwell-paced list. To cause the list to be paced by dwell time use:

```
LIST:STEP AUTO
```

As each dwell time elapses, the next point is immediately output. This is also the *RST setting.

If you need the output to closely follow asynchronous events, then a trigger-paced list is more appropriate. In a trigger-paced list, the list advances one point for each trigger received. To enable trigger-paced lists use:

```
LIST:STEP ONCE
```

The dwell time associated with each point determines the minimum time that the output remains at that point. If a trigger is received before the previous dwell time completes, the trigger is ignored. Therefore, to ensure that no triggers are lost, program the dwell time minimum.

Step 6 : Use the transient trigger system to trigger the list. This is described in detail under "Triggering Output Changes"

6.5 Triggering Output Changes

The following transient trigger sources can be selected:

- IMMEDIATE Generates a trigger when the trigger system is initiated.
- BUS Selects IEEE-488 bus triggers.

6.5.1 Trigger System Model

Figure 6-2 is a model of the trigger system. The rectangular boxes represent states. The arrows show the transitions between states. These are labeled with the input or event that causes the transition to occur.

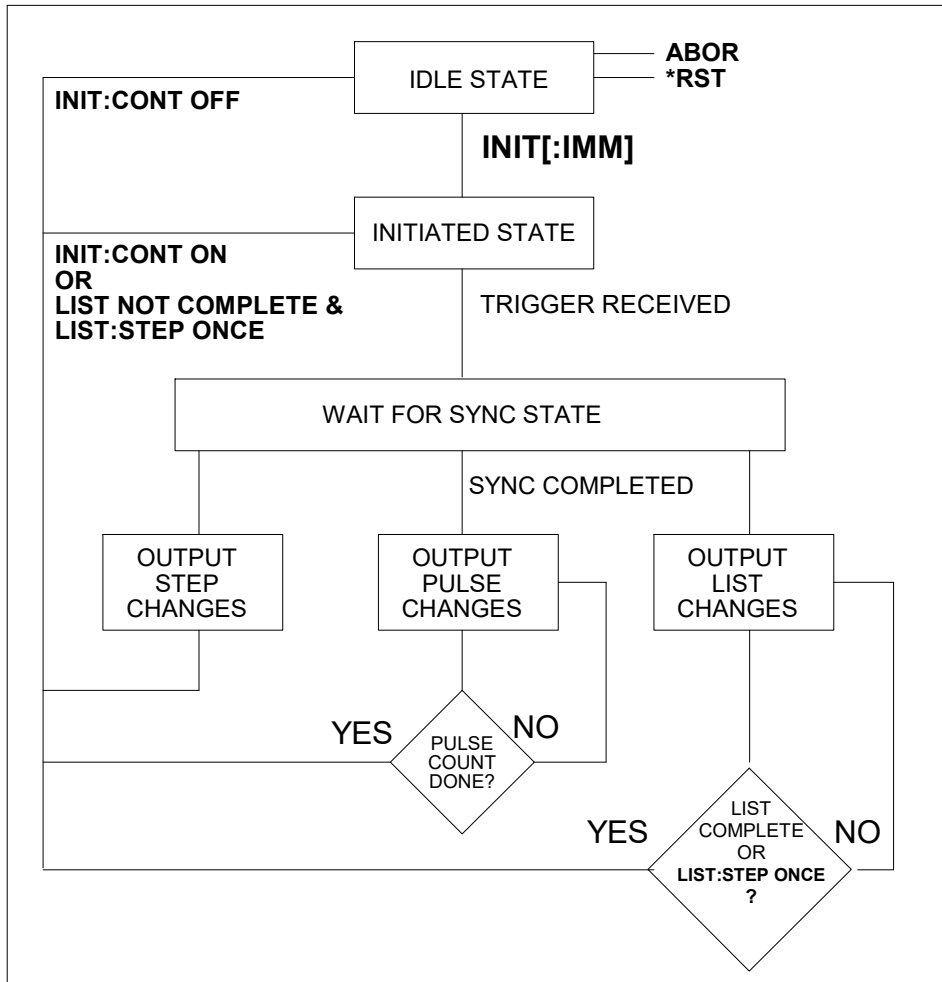

Figure 6-2: Transient Trigger System Model

6.5.2 Initiating the Output Trigger System

When the source is turned on, the trigger subsystem is in the idle state. In this state, the trigger subsystem ignores all triggers. Sending the following commands at any time returns the trigger system to the Idle state:

```
ABORT
*RST
```

The INITiate commands move the trigger system from the Idle state to the Initiated state. This enables the AC source to receive triggers. To initiate for a single triggered action, use:

```
INITiate:IMMEDIATE
```

After a trigger is received and the action completes, the trigger system will return to the Idle state. Thus it will be necessary to initiate the system each time a triggered action is desired. To keep a trigger system initiated for multiple actions without having to send an initiate command for each trigger, use:

```
INITiate:CONTINUOUS ON
```

Selecting the Trigger Source

The trigger system is waiting for a trigger signal in the Initiated state. Before generating a trigger, a trigger source must be select.

To select IEEE-488 bus triggers (group execute trigger, device trigger, or *TRG command), use:

```
TRIGger:SOURce BUS
```

To select a trigger source that is always true, use:

```
TRIGger: SOURce IMM
```

The immediate source can be combined with INITiate:CONTINUOUS ON to generate repetitive output transients. A transition from the Initiated state to the Delay state is made when the trigger signal is received.

6.5.3 Synchronizing Output Changes to a Reference Phase Angle

An output transient normally occurs immediately when the trigger signal is received. For some applications it is desirable for the transient to be synchronized with a particular phase of the output waveform such as the zero crossing point (0°) or the positive peak (90°).

To synchronize the start of a transient with a particular phase angle of the internal phase reference, you must select PHASE as the trigger source. Use:

```
TRIGger:SYNC:SOURce PHASE
```

To select the desired phase, use:

```
TRIGger:SYNC:PHASE 90
```

which specifies the 90 degree phase angle of the internal phase reference as the point where the transient begins.

To turn off transient phase synchronization, use:

```
TRIGger: SYNC:SOURce IMMEDIATE
```

When IMMEDIATE is selected, the trigger system goes directly to the Output state. This is the parameter selected at *RST.

6.5.4 Generating Triggers

Providing that you have specified the appropriate trigger source, you can generate triggers as follows:

Single Triggers

By sending one of the following over the IEEE-488:

- INIT
- *TRG
- a group execute trigger

Continuous Triggers

By sending the following commands over the IEEE-488:

- TRIGger: SOURce IMMEDIATE
- INITiate:CONTInuous ON

When the trigger system enters the Output Change state upon receipt of a trigger (see Figure 6-5), the triggered functions are set to their programmed trigger levels. When the triggered actions are completed, the trigger system returns to the Idle state.

Specifying a Dwell Time for Each List Point

Each voltage and frequency list point has an associated dwell time specified by:

```
LIST:DWELL <n> ,<n>
```

where <n> specifies the dwell time in seconds. The number of dwell points must equal the number of output points. If a dwell list has only one value, that value will be applied to all points in the output list. After each new output level or point is programmed, the output remains at that point in the list for the programmed dwell interval before the list advances to the next point. Only an ABORt command can transfer the system out of the Dwelling state.

At the end of the dwell interval, the transition to the next state depends on whether or not the list has completed its sequencing and the state of the LIST:STEP command (see Figure 6-5).

If the list is completed, the trigger system returns to the Idle state.

If the list is not completed, then the system reacts as follows:

LIST:STEP ONCE	programs the trigger system to return to the Initiated state to wait for the next trigger.
LIST:STEP AUTO	programs the trigger system to immediately execute the next list point.

6.6 Acquiring Measurement Data

The source has the capability to return a number of current, voltage, and power measurements. When the AC source is turned on, it is continuously sampling the instantaneous output voltage and current for several output cycles and writing the results into a buffer. The buffer holds 4096 voltage and current data points.

The AC source uses the data from the voltage and current buffer to calculate the requested measurement information. Data in the voltage and current buffers is always re-acquired for subsequent measurement requests. There are two ways to make measurements:

- Use the MEASure commands to immediately start acquiring new voltage and current data, and return measurement calculations from this data as soon as the buffer is full. This is the easiest way to make measurements, since it requires no explicit trigger programming.
- Use an acquisition trigger to acquire the voltage and current data from the buffer. Then use the FETCh commands to return calculations from the data that was retrieved by the acquisition trigger. This method gives you the flexibility to synchronize the data acquisition with an external signal. FETCh commands do not trigger the acquisition of new measurement data, but they can be used to return many different calculations from the same set of data that was captured as a result of same acquisition trigger.

The query response for measurements is not immediate. The source will accept commands from the interface while the measurement is in progress. To prevent the source from accepting additional commands during measurement the *WAI must be used with the measurement query command.

```
MEAS:FREQ?;*WAI
```

Making triggered measurements with the acquisition trigger system is discussed under "Triggering Measurements".

Note	<i>For each MEASure form of the query, there is a corresponding query that begins with the header FETCh. FETCh queries perform the same calculation as their MEASure counterparts, but do not cause new data to be acquired. Data acquired by an explicit trigger or a previously programmed MEASure command are used.</i>
-------------	---

6.6.1 Voltage and Current Measurements

To the rms voltage or current, use:

```
MEASure:VOLTage?or
```

```
MEASure:CURRent?
```

To measure the dc voltage or current, use:

```
MEASure:VOLTage:DC?or
```

```
MEASure:CURRent:DC?
```

To measure the maximum current amplitude and the current crest factor, use:

```
MEASure:CURRent:AMPLitude:MAXimum?
```

```
MEASure:CURRent:CREStfactor?
```

To reset the peak measurement , use

```
MEAS:CURR:AMPL:RESet
```

6.6.2 Power Measurements

The MEASure queries can return real, and apparent power measurements as well as dc power and power factor using the following commands:

MEASure:POWer:AC:APParent?	measures the AC component of apparent power in VA
MEASure:POWer:AC:REAL?	measures the in-phase component of power in watts
MEASure:POWer:AC:PFACTOR?	returns the output power factor
MEASure:POWer:DC?	measures the dc component of power

6.6.3 Frequency Measurements

To measure the frequency, use the following command:

```
MEASure:FREQuency?
```

6.6.4 Harmonic Measurements

The MEASure and FETCh queries can return the amplitude and phase of up to the 50th harmonic of voltage and current. They can also return the total harmonic distortion in the output voltage or current. For example, to return readings for an individual harmonic component, use the following commands:

```
MEASure:CURRent:HARMonic:AMPLitude? <harmonic number>
MEASure:CURRent:HARMonic:PHASe? <harmonic number>
MEASure:VOLTagE:HARMonic:AMPLitude? <harmonic number>
MEASure:VOLTagE:HARMonic:PHASe? <harmonic number>
```

Harmonic numbers are related to the programmed frequency of output voltage. Queries sent with an argument of 0 return the dc component. An argument of 1 indicates the fundamental frequency, 2 indicates the second harmonic, 3 indicates the third, and so on.

The maximum harmonic component that can be read is limited by the fundamental measurement bandwidth, which is 19.53 kHz for a single phase configuration and 6.51kHz for three phase configuration. An error is generated if a query is sent for a harmonic that has a frequency greater than the bandwidth above. To return all the harmonic components with a single query, use the following commands:

```
MEASure:ARRay:CURRent:HARMonic:AMPLitude? [<n>]
MEASure:ARRay:CURRent:HARMonic:PHASe? [<n>]
MEASure:ARRay:VOLTagE:HARMonic:AMPLitude? [<n>]
MEASure:ARRay:VOLTagE:HARMonic:PHASe? [<n>]
```

These queries always return 51 data values, from the dc component up to the the numeric option field <n> if present or the 50th harmonics. Any harmonics that represent frequencies greater than the measurements bandwidth are returned as the value 0. To return the percentage of total harmonic distortion in the output voltage or current, use the following commands:

```
MEASure:CURRent:HARMonic:THD?
MEASure:VOLTagE:HARMonic:THD?
```

6.6.5 Simultaneous Output Phase Measurements

You can return simultaneous measurements from all output phases of the source in the three phase mode using the FETCh query. Unlike MEASure queries, FETCh queries do not trigger the acquisition of new data when they are executed. First, you must initiate the measurement trigger system and generate a measurement trigger as explained in the following section "Triggering Measurements". When the measurement data has been acquired by the voltage and current data buffers for each output phase, use INSTRument:NSElect to select each phase, and FETCh to return the specified measurement data. The following commands return rms voltage:

```
INSTRument:NSElect 1
FETCh:VOLTage:AC?;*WAI
INSTRument:NSElect 2
FETCh:VOLTage:AC?;*WAI
INSTRument:NSElect 3
FETCh:VOLTage:AC?;*WAI
```

6.6.6 Returning Voltage and Current Data From the Data Buffer

The MEASure and FETCh queries can also return all 4096 data values of the instantaneous voltage and current buffers. These are:

```
MEASure:ARRay:CURRent[:DC]?;*WAI
MEASure:ARRay:VOLTage[:DC]?;*WAI
```

6.6.7 Triggering Measurements

You can use the data acquisition trigger system to synchronize the timing of the voltage and current data acquisition with an external trigger source. Then use the FETCh commands to return different calculations from the data acquired by the measurement trigger.

The following measurement trigger sources can be selected:

IMMediate	Acquire the measurements immediate
SYNChronize	Internal to phase A angle
BUS	IEEE-488 device, *TRG, or <GET> (Group Execute Trigger)
TTLTrg	The signal driving the Trigger Out

6.6.8 Measurement Trigger System Model

Figure 6-3 is a model of the measurement trigger system. The rectangular boxes represent states. The arrows show the transitions between states. These are labeled with the input or event that causes the transition to occur.

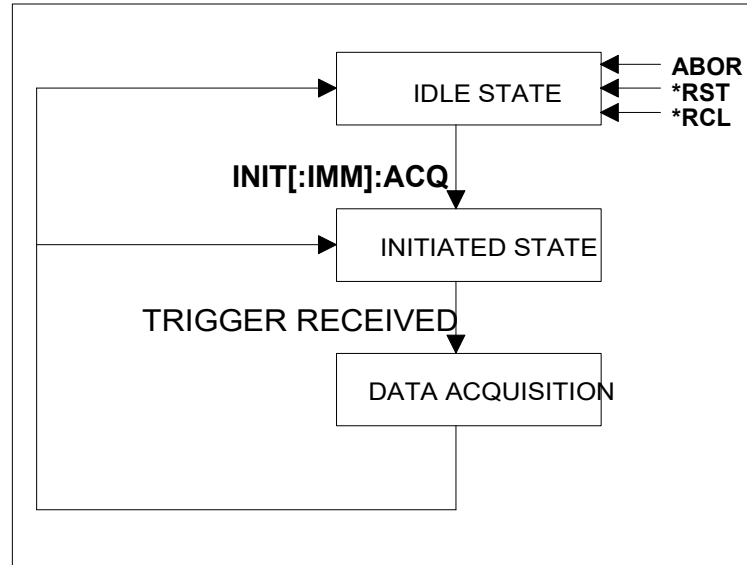

Figure 6-3: Measurement Acquisition Trigger Model

6.6.9 Initiating the Measurement Trigger System

When the AC source is turned on, the trigger system is in the idle state. In this state, the trigger system ignores all triggers. Sending the following commands at any time returns the trigger system to the Idle state:

```
ABORT *RST *RCL
```

The INITiate commands move the trigger system from the Idle state to the Initiated state. This enables the AC source to receive triggers. To initiate for a measurement trigger, use:

```
INITiate:IMMEDIATE:ACquire
```

After a trigger is received and the data acquisition completes, the trigger system will return to the Idle state. Thus it will be necessary to initiate the system each time a triggered acquisition is desired.

Note: *You cannot initiate measurement triggers continuously. Otherwise, the measurement data in the data buffer would continuously be overwritten by each triggered measurement.*

6.6.10 Selecting the Measurement Trigger Source

The trigger system is waiting for a trigger signal in the Initiated state. Before you generate a trigger, you must select a trigger source. To select the SYNC Trigger to start the measurement at specific phase angles in the waveform:

```
TRIGger:ACQuire:SOURce SYNC
TRIGger:SYNC:SOUR PHAS
TRIGger:SYNC:PHASE 0
```

To select IEEE-488 bus triggers (group execute trigger, device trigger, or *TRG command), use:

```
TRIGger:ACQuire:SOURce BUS
```

To select the signal driving the Trigger Out from the transient, use:

```
TRIGger:ACQuire:SOURce TTLTrg
```

6.6.11 Generating Measurement Triggers

Providing that you have specified the appropriate trigger source, you can generate triggers as follows:

- By sending one of the following over the IEEE-488:
 - TRIGger:ACQuire:IMMediate
 - *TRG
 - a group execute trigger (GET)
- By waiting for a specific phase angle of the waveform
- By generating an output transient that causes the Trig Out to output a pulse.
- By pressing the front panel START soft key in the HARMONICS/WAVEFORM when the unit is operating in local mode.

6.7 Controlling the Instantaneous Voltage and Current Data Buffers

Measurements taken by the AC/DC power source are based on a digital representation of the voltage and current waveforms. Both waveforms are digitized with 18 bits of amplitude resolution and 25.6 μsec of time resolution. (49Ks/sec real-time sampling rate) for single phase configuration. The available memory depth to hold this information is 4K (4096 samples) for each waveform. This section covers the SCPI commands that can be used to control the position of the trigger point in the 4K deep data buffer.

6.7.1 Query the Voltage and Current Sampling Rate [3Pi Controller Only]

The output voltage and current sampling rate is:

96 kHz (period = 10.4 μsec) for single-phase configuration. This means that it takes about 42.6 milliseconds to fill up 4096 data points in the voltage and current data buffers with the information required to make a measurement calculation.

You can query this data sampling rate with:

```
SENSe:SWEep:TINTerval?
```

The sample period is 31.2 microseconds for the three-phase mode. The sample interval can be increased from its minimum value in increments of this minimum value up to 10 times. This increases the data acquisition window at the expense of sampling resolution. Be aware of possible aliasing if higher fundamental frequencies are programmed or if higher frequency harmonics are present in the voltage or current when decreasing the sample rate. See paragraph 4.16 for command syntax.

6.7.2 Pre-event and Post-event Triggering

The range for this offset is:

-42.6 msec to 1000 msec in single-phase mode or -128 msec to 1000 msec in three-phase mode (at the highest available sample rates).

As shown in the following figure, when the offset is negative, the values at the beginning of the data record represent samples taken prior to the trigger. When the value is 0, all of the values are taken after the trigger. Values greater than zero can be used to program a delay time from the receipt of the trigger until the data points that are entered into the buffer are valid.

(Delay time = Offset \times Sample period)

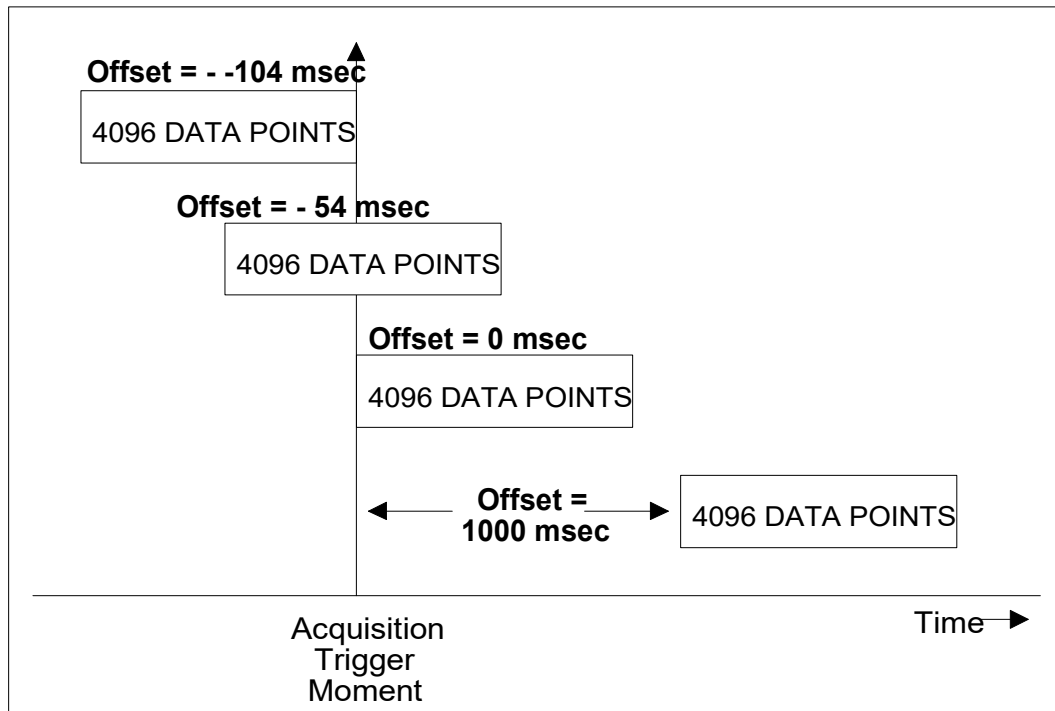

Figure 6-4: Pre-event and Post-event Triggering

6.8 Trigger System Summary

Figure 6-5 shows a functional block diagram of the AC/DC source's trigger system. If both trigger systems are initiated at the same time, the Acquisition trigger system will respond to the first trigger generated while the transient trigger system will respond to the second trigger. Thus, the acquisition has the highest priority.

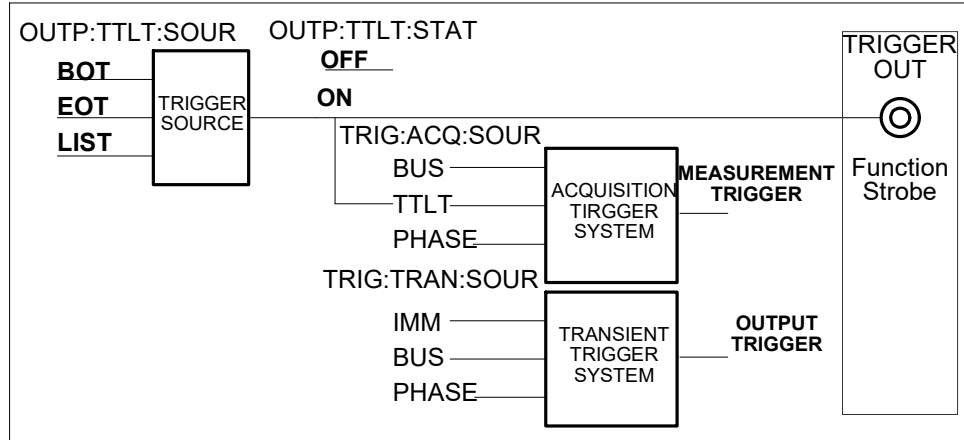

Figure 6-5: Trigger system block diagram

7. Status Registers

You can use status register programming to determine the operating condition of the AC source at any time. For example, you may program the AC source to generate an interrupt (assert SRQ) when an event such as a current limit occurs. When the interrupt occurs, your program can then act on the event in the appropriate fashion.

Figure 7-1 shows the status register structure of the AC/DC source. Table 5-1 defines the status bits. The Standard Event, Status Byte, and Service Request Enable registers as well as the Output Queue perform standard IEEE-488 functions as defined in the IEEE 488.2 Standard Digital Interface for Programmable Instrumentation. The Operation Status, and the Questionable Status registers, implement functions that are specific to the AC/DC source.

7.1 Power-On Conditions

All status register groups are cleared at power on. This means all data bits and all Event Enable register bits are cleared. It is possible however to set the PON mask in the Event enable register to cause a SRQ. This can be accomplished using the *PSC command. Once set, this condition is retained in non-volatile memory and will be recalled when power is applied to the AC/DC source. See paragraph 5.7 for details on the use of the *PSC command.

7.2 Operation Status Group

The Operation Status group records signals that occur during normal operation. The group consists of the following registers:

Register	Command	Description
Condition	STAT:OPER:COND?	A register that holds real-time status of the circuits being monitored. It is a read-only register.
Event	STAT:OPER:EVEN?	A register that latches any condition. It is a read-only register that is cleared when read.
Enable	STAT:OPER:ENAB <n>	A register that functions as a mask for enabling specific bits from the Event register. It is a read/write register.

Table 7-1: Operation Status Register

The outputs of the Operation Status register group are logically-ORed into the OPER(ation) summary bit (7) of the Status Byte register.

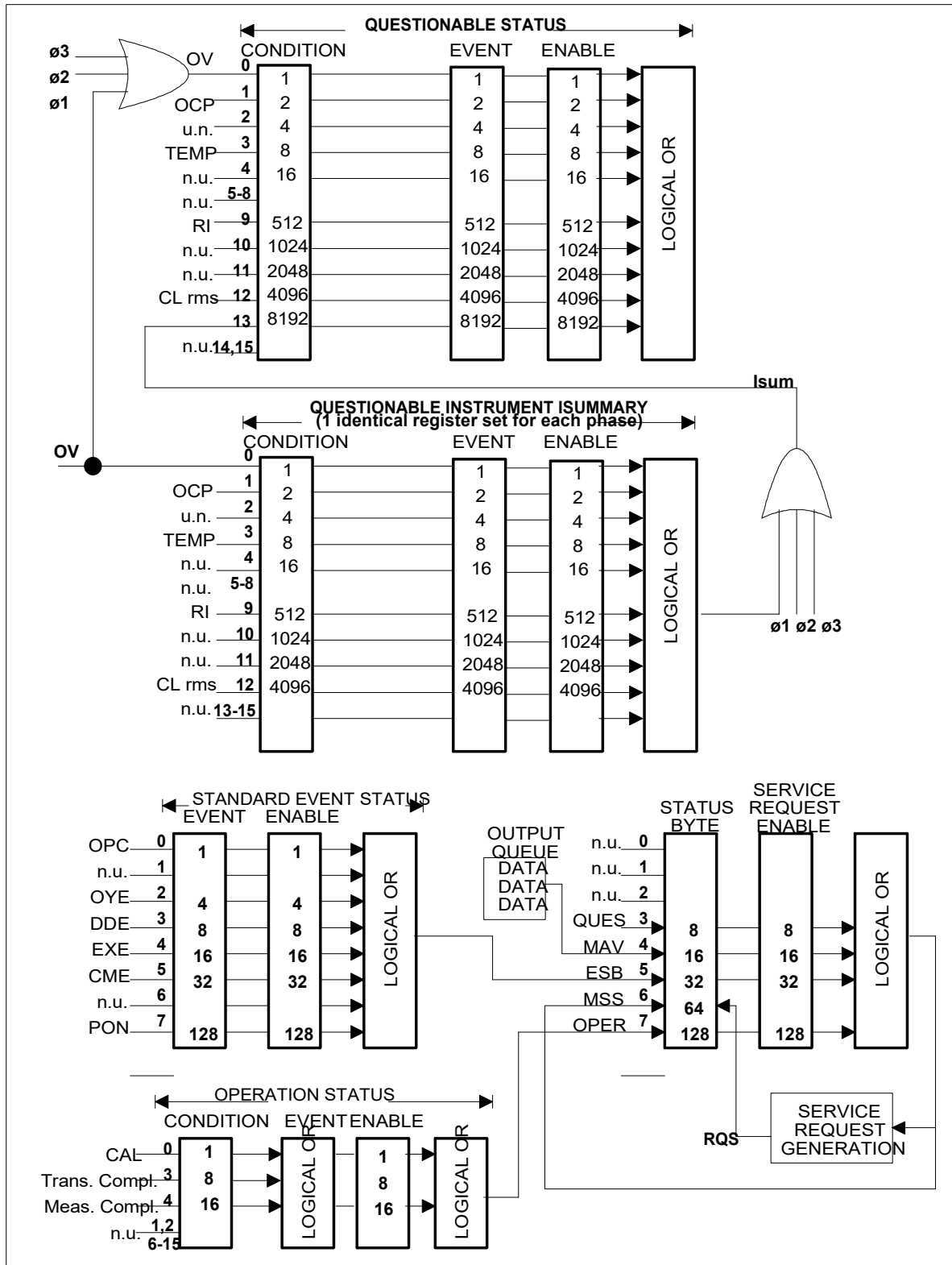

Figure 7-1: Status System Model

Bit	Signal	Meaning
Operation Status Group		
0	CAL	Interface complete its calibration cycle
3	TRANS	Transient is completed
4	MEAS	Measurement is completed
Questionable and Questionable Instrument Isummary Status Groups		
0	OV	Output voltage faulted, output voltage differ from program value
1	OCP	The overcurrent protection circuit has tripped
3	TO	An overtemperature condition has occurred
9	RI	The remote shut down state is active
12	Clrms	The rms current limit circuit is active
14	n/a	
Standard Event Status Group		
0	OPC	Operation complete
2	QYE	Query error
3	DDE	Device-dependend error
4	EXE	Execution error
5	CME	Command error
7	PON	Power-on
Status Byte and Service Request Enable Registers		
3	QUES	Questionable status summary bit
4	MAV	Message Available summary bit
5	ESB	Event Status Summary bit
6	MSS	Master Status Summary bit
	RQS	Request Service bit
7	OPER	Operation status summary bit

Table 7-2: Configuration of Status Register

7.3 Questionable Status Group

The Questionable Status registers record signals that indicate abnormal operation of the AC source. As shown in Figure 7-1, the group consists of the same type of registers as the Status Operation group.

Register	Command	Description
Condition	STAT:QUES:COND?	A register that holds real-time status of the circuits being monitored. It is a read-only register.
Event	STAT:QUES:EVEN?	A register that latches any condition. It is a read-only register that is cleared when read.
Enable	STAT:QUES:ENAB <n>	A register that functions as a mask for enabling specific bits from the Event register. It is a read/write register.

Table 7-3: Questionable Status Register

The outputs of the Questionable Status group are logically-ORed into the QUEStionable summary bit (3) of the Status Byte register.

7.4 Standard Event Status Group

This group consists of an Event register and an Enable register that are programmed by Common commands. The Standard Event register latches events relating to the interface communication status (see Figure 7-1). It is a read-only register that is cleared when read. The Standard Event Enable register functions similarly to the enable registers of the Operation and Questionable status groups.

Command	Action
*ESE	programs specific bits in the Standard Event Enable register.
*ESR?	reads and clears the Standard Event Event register.

The PON bit in the Standard Event Event register is set whenever the AC source is turned on. The most common use for PON is to generate an SRQ at power-on following an unexpected loss of power.

7.5 Status Byte Register

This register summarizes the information from all other status groups as defined in the IEEE 488.2 Standard Digital Interface for Programmable Instrumentation. The bit configuration is shown in Table 7-2.

Command	Action
*STB?	reads the data in the register but does not clear it (returns MSS in bit 6)
serial poll	reads and clears the data in the register (returns RQS in bit 6)

The MSS Bit

This is a real-time (unlatched) summary of all Status Byte register bits that are enabled by the Service Request Enable register. MSS is set whenever the AC source has one or more reasons for requesting service. *STB? reads the MSS in bit position 6 of the response but does not clear any of the bits in the Status Byte register.

The RQS Bit

The RQS bit is a latched version of the MSS bit. Whenever the AC source requests service, it sets the SRQ interrupt line true and latches RQS into bit 6 of the Status Byte register. When the controller does a serial poll, RQS is cleared inside the register and returned in bit position 6 of the response. The remaining bits of the Status Byte register are not disturbed.

The MAV bit and Output Queue

The Output Queue is a first-in, first-out (FIFO) data register that stores AC source-to-controller messages until the controller reads them. Whenever the queue holds one or more bytes, it sets the MAV bit (bit 4) of the Status byte register.

7.6 Examples

The following section contains examples of commonly used operations involving the status registers.

7.6.1 Determining the Cause of a Service Interrupt

You can determine the reason for an SRQ by the following actions:

Step 1 : Determine which summary bits are active. Use

```
*STB? or serial poll
```

Step 2 : Read the corresponding Event register for each summary bit to determine which events caused the summary bit to be set. Use:

```
STATus:QUEStionable:EVENT?
```

```
STATus:OPERation:EVENT?
```

```
ESR?
```

Note: *When an Event register is read, it is cleared. This also clears the corresponding summary bit.*

Step 3 : Remove the specific condition that caused the event. If this is not possible, the event may be disabled by programming the corresponding bit of the status group Enable. A faster way to prevent the interrupt is to disable the service request by programming the appropriate bit of the Service Request Enable register.

7.6.2 Servicing Questionable Status Events

This example assumes you want a service request generated whenever the AC source's overvoltage, overcurrent, or overtemperature circuits have tripped. From Figure 7-1, note the required path for Questionable Status conditions at bits 0, 1, and 3 to generate a service request (RQS) at the Status Byte register. The required register programming is as follows:

Step 1 : Program the Questionable Status Enable register to allow the latched events to be summed into the QUES summary bit. Use:

```
STATus:QUEStionable:ENABle 11
```

Step 2 : Program the Service Request Enable register to allow the QUES summary bit from the Status Byte register to generate RQS. Use:

```
*SRE 8
```

Step 3 : When you service the request, read the event register to determine which Questionable Status Event register bits are set and clear the register for the next event. Use:

```
STATus:QUEStionable:EVENT?
```

7.7 SCPI Command Completion

SCPI commands sent to the AC source are processed either sequentially or in parallel. Sequential commands finish execution before a subsequent command begins. Parallel commands allow other commands to begin executing while the parallel command is still executing. Commands that affect list and trigger actions measurements and calibration are among the parallel command.

The *WAI, *OPC, and *OPC? common commands provide different ways of indicating when all transmitted commands, including any parallel ones, have completed their operations. The syntax and parameters for these commands are described in chapter 5. Some practical considerations for using these commands are as follows:

- *WAI This prevents the AC source from processing subsequent commands until all pending operations are completed except for transients.
- *OPC? This places a 1 in the Output Queue when all pending operations have completed. Because it requires your program to read the returned value before executing the next program statement, *OPC? can be used to cause the controller to wait for commands to complete before proceeding with its program.
- *OPC 1 This sets the OPC status bit when all pending operations have completed. Since your program can read this status bit on an interrupt basis, *OPC allows subsequent commands to be executed.
- TRIG:STATe? This query will report the state of the transient trigger subsystem and will return IDLE, ARM or BUSY to allow the user monitor the state of the trigger system.

8. Option Commands

8.1 Introduction

The CSW Series offers a number of options that are implemented in the power source controller. If one or more of these options are installed, they may be used from both the front panel and the interface. For front panel operation of any of these firmware options, consult the User Manual supplied with the unit. For use in an automated test system, this chapter contains the command sub system syntax for the available test options.

Specifically, the following firmware options are available at the time of this manual's printing:

- IEC 61000-4-11, Option -411
- IEC 61000-4-13, Option -413
- MIL-STD 704E, Option -704
- RTCA/DO-160D, Option -160
- Airbus ABD0100.1.8 Option -ABD (Requires CSWGui Windows Software. No SCPI commands available.)
- Airbus AMD24 Option -AMD (Requires CSWGui Windows Software. No SCPI commands available.)
- Boeing B787-0147 Option -B787 (Requires CSWGui Windows Software. No SCPI commands available.)
- WattHour Meter, Option -WHM

The AC/DC power source will report all installed options, including any firmware options, when queried using the SYST:CONF:BYTE? or *OPT? command. Additional firmware options may be added over time. Consult the factory for additional information on firmware options not listed here but present on your unit.

8.2 IEC 1000-4-11 (-411)

The following are the remote commands set for IEC1000-4-11. The ABORt command will terminate a test in progress at any time. Test completion can be checked using the *OPC? query if the *OPC 1 command is issued immediately after an IEC1000-4-11 command. Upon completion of the test run *OPC? will return a 1. This may be relevant for ATE applications in view of long test times for some IEC 1000-4-11 test sequences.

Details on the actual tests performed as a result of each of these commands may be found in the IEC 1000-4-11 option section of the User Manual which is supplied with the AC/DC power source.

```
IEC411:
  [:NOMinal]
    :VOLTage
  :DIPS
    :RUN
      [:ALL]
      :SINGle
    :VOLTage
      [:PERCent]
    :CYCLes
    :ANGLE
  :STATe
  :VARiants
    :RUN
      [:ALL]
      :SINGle
    :HOLD
      :TIME
      :VOLTage
        [:PERCent]
    :FALL
      [:TIME]
    :RISE
      [:TIME]
```

IEC411[:NOMinal]:VOLTage

This command set the nominal voltage for the test

Command Syntax	IEC411[:NOMinal]:VOLTage <NRf>
Parameters	<volatge>
Examples	IEC411:VOLT 230
Query Syntax	IEC411:VOLT?
Returned Parameters	<NR2>

IEC411:DIPS:RUN[:ALL]

This command will cause the automated test sequence by the standard to run. Refer to Table 13 in the User Manual.

Command Syntax	IEC411:DIPS:RUN[:ALL]
Parameters	<none>
Examples	IEC411:DIPS:RUN
Query Syntax	none
Returned Parameters	<none>

IEC411:DIPS:RUN:SINGLE

This command will run a single test once. The test is defined by the dip parameters voltage, cycle and angle.

Command Syntax	IEC411:DIPS:RUN:SINGLE
Parameters	<none>
Examples	IEC411:DIPS:RUN:SING
Query Syntax	none
Returned Parameters	<none>

IEC411:DIPS:VOLTage[:PERCent]

This command defines the dip voltage as a percentage of the nominal voltage when the run single command is used.

Command Syntax	IEC411:DIPS:VOLTage[:PERCent]
Parameters	<numeric>
Examples	IEC411:DIPS:VOLT 20
Query Syntax	IEC411:DIPS:VOLT?
Returned Parameters	<NR2>

IEC411:DIPS:CYCLes

This command defines the duration of the dip voltage expressed in the number of cycles.

Command Syntax	IEC411:DIPS:CYCLes
Parameters	<numeric>
Examples	IEC411:DIPS:VOLT 20
Query Syntax	IEC411:DIPS:VOLT?
Returned Parameters	<NR2>

IEC411:DIPS:ANGLE

This command sets the start phase angle for the dips.

Command Syntax	IEC411:DIPS:ANGLE
Parameters	<numeric>
Examples	IEC411:DIPS:ANGL 90
Query Syntax	IEC411:DIPS:ANGL?
Returned Parameters	<NR2>

IEC411:STATE

This command will enable the IEC411 option and initialize the associated data.

Command Syntax	IEC411:STATE <state>
Parameters	<ON OFF>
Examples	IEC411:STAT ON
Query Syntax	IEC411:STAT?
Returned Parameters	<boolean>

IEC411:VARiants:RUN[:ALL]

This command will cause the variants automated test sequence by the standard to run. Refer to Table 14 in the User Manual.

Command Syntax	IEC411:VARiants:RUN[:ALL]
Parameters	<none>
Examples	IEC411:VAR:RUN
Query Syntax	none
Returned Parameters	<none>

IEC411:VARiants:RUN:SINGle

This command will run a single variant test once. The test is defined by the variants parameters voltage, cycle and angle.

Command Syntax	IEC411:VARiants:RUN:SINGle
Parameters	<none>
Examples	IEC411:VAR:RUN:SING
Query Syntax	none
Returned Parameters	<none>

IEC411:VARiants:HOLD:TIME

This command will set the variant hold time in seconds. Refer to Figure 9-13 in the User Manual.

Command Syntax	IEC411:VARiants: HOLD:TIME <NRf>
Parameters	<seconds>
Examples	IEC411:VAR: HOLD:TIME 0.5
Query Syntax	IEC411:VAR: HOLD:TIME?
Returned Parameters	<NR2>

IEC411:VARiants:HOLD:VOLTage[:PERCent]

This command will set the variant level as a percentage of the nominal volts for the duration of the hold time.

Command Syntax	IEC411:VARiants:HOLD:VOLTage[:PERCent] <NRf>
Parameters	<percentage>
Examples	IEC411:VAR: HOLD:VOLT 70
Query Syntax	IEC411:VAR: HOLD:VOLT?
Returned Parameters	<NR2>

IEC411:VARiants:FALL[:TIME]

This command will set the variant fall time in seconds. Refer to Figure 9-13 in the User Manual.

Command Syntax	IEC411:VARiants:FALL[:TIME] <NRf>
Parameters	<seconds>
Examples	IEC411:VAR:FALL 0.5
Query Syntax	IEC411:VAR:FALL?
Returned Parameters	<NR2>

IEC411:VARiants:RISE[:TIME}

This command will set the variant rise time in seconds. Refer to Figure 9-13 in the User Manual.

Command Syntax	IEC411:VARiants:RISE:TIME <NRf>
Parameters	<seconds>
Examples	IEC411:VAR:RISE:TIME 0.25
Query Syntax	IEC411:VAR:RISE:TIME?
Returned Parameters	<NR2>

8.3 IEC 1000-4-13 (-413)

8.3.1 IEC 1000-4-13 Subsystem

The following are the remote commands set for IEC1000-4-13. The ABORt command will terminate the test in progress at any time. Test completion can be checked using the *OPC? query if the *OPC 1 command is issued immediately after an IEC1000-4-13 RUN command. Upon completion of the test run, *OPC? will return a 1. This may be relevant for ATE applications in view of long test times.

Firmware revision note: Support for the Meister curve test was added with firmware revision 0.31. There are some new commands associated with this test that will only be supported if the unit you are using has firmware revision 0.31 or higher.

:IEC413

:STATe	Enable or disable the IEC test.
:RUN	Run the IEC test
:PAUSe	Pause test
:CLASs <2 3 USER>	
:INDVidual	
:HARMonics	
[:NUMber]	Set the IEC harmonic number.
:IHARmonics	
[:FREQUency]	Set the IEC interharmonics frequency.
:SWEep	
[:RANGe]	Set the Sweep range
:STEP	
[:SIZE]	Set sweep step size.
:GROUp	Select the IEC group.
:FCURve	
:LEVel	Set flat curve level.
:DWELl	Set flat curve dwell time.
:PAUSe	Set flat curve pause time
:MCURve	
:LEVel	Set mcurve levels.
:DWELl	Set mcurve dwell time
:PAUSe	Set mcurve pause time
:OSWing	
:LEVel	Set over swing level.
:PHASe	Set over swing harmonic phase angle.
:DWELl	Set over swing dwell time
:PAUSe	Set over swing pause time.
:SWEep	
:LEVel	Set sweep interharmonics level
:DWELl	Set sweep dwell time.
:CURRent	
[:DATA]?	Get interharmonics current.
:RESonant?	Get interharmonics current at resonant
:FREQUency	
[:DATA]?	Get interharmonics frequency
:RESonant?	Get interharmonics frequency at resonant
:HARMonics	
:LEVel	Set harmonics level.
:PHASe	Set harmonics phase.
:DWELl	Set harmonics dwell.
:PAUSe	Set harmonics pause.

:TABLE	Select Individual harmonic table 1,2,3 or ALL.
:IHARmonics	
:LEVel	Set interharmonics level.
:DWELl	Set interharmonics dwell.
:PAUSE	Set interharmonics pause.

IEC413:STATe

This command will enable the IEC413 and initialize the associated data. Note that user defined test levels for the USER group can only be programmed when the IEC413 state is OFF.

Command Syntax	IEC413:STATe <state>
Parameters	<ON OFF 1 0 >
Examples	IEC413:RUN STAT ON
Query Syntax	IEC413:STAT?
Returned Parameters	<boolean>

IEC413:RUN

This command will run the test. The parameters will define the section of test to be run.

Command Syntax	IEC413:RUN <group>
Parameters	< ALL GROUp RANGe POINT >
Examples	IEC413:RUN ALL
Query Syntax	IEC413:RUN?
Returned Parameters	<group>

IEC413:PAUSE

This command will cause the test to pause at the time the command is issued.

Command Syntax	IEC413:PAUSE <boolean>
Parameters	ON OFF 1 0
Examples	IEC413:PAUS ON
Query Syntax	IEC413:PAUS?
Returned Parameters	<boolean>

IEC413:CLASs

This command will select the class. There are two predefined classes 2 and 3. Class 1 is supported through the use of the USER defined class. Other tests levels can be set in the USER class as well.

Command Syntax	IEC413:CLASs <class>
Parameters	2 3 USER
Examples	IEC413:CLAS 3
Query Syntax	IEC413:CLAS?
Returned Parameters	<class>

IEC413:INDVidual:HARMonics[:NUMBer]

This command is used to set the desired harmonic number when the IEC413:RUN POINT is used.

Command Syntax	IEC413:INDVidual:HARMonics[:NUMBer]] <NRf>
Parameters	2 to 40
Examples	IEC413:INDV:HARM 3
Query Syntax	IEC413:INDV:HARM?
Returned Parameters	<NR1>

IEC413:INDVidual:IHARMonics[:FREQuency]

This command is used to set the desired Interharmonic frequency when the IEC413:RUN POINT is used.

Command Syntax	IEC413:INDVidual:IHARMonics[:FREQuency]] <NRf>
Parameters	within frequency range and step size
Examples	IEC413:INDV:IHARM 400
Query Syntax	IEC413:INDV:IHARM?
Returned Parameters	<NR1>

IEC413:INDVidual:SWEep[:RANGe]

This command is used to set the desired Interharmonic frequency range for the sweep group or interharmonics group when the IEC413:RUN RANGE is used.

Command Syntax	IEC413:INDVidual:SWEep[:RANGe]] <NRf>
Parameters	0 to 4
Examples	IEC413:INDV:SWE 0
Query Syntax	IEC413:INDV:SWE?
Returned Parameters	<NR1>

IEC413:STEP[:SIZE]

This command is used to set the desired step size for the Interharmonic group and sweep group. The command will accept one parameter or five parameters. If one parameter is used, the step size for the current range setting is the only parameter that gets updated.

Command Syntax	IEC413:STEP[:SIZE]] <NRf[,NRf1,...,NRf4]>
Parameters	query the min and max for range of data
Examples	IEC413:STEP 5 IEC413:STEP 2,5,10,10,50
Query Syntax	IEC413:STEP?
Returned Parameters	NR10,...,NR14

IEC413:GROup

This command is used to select the group. If RUN:GROUp is used, the test will run for only the selected group.

Command Syntax	IEC413:GROup <group>
Parameters	FCURve OSWing SWEep HARMonics IHARmonics MCURve
Examples	IEC413:GRO:SWE
Query Syntax	IEC413:GRO?
Returned Parameters	<group>

Note: The MCUR parameter for the IEC413:GROup command is not recognized in firmware revision 0.31 due to a command parser error. This has been corrected in revision 0.32 and higher. The workaround for this parser error is to send an empty parameter instead. This will select the MCURve group but will also result in an –113 “Undefined Header” error. The error should be read and discarded to clear the error queue. E.g. for revision 0.31, send “IEC413:GRO ”. The pair of single quotes signify an empty string.

IEC413:FCURve:LEVel

This command will set the clip level for the flat curve test. The class must be set prior to this command. The IEC413:STATe must be in the off position and the user class is selected to accept the command.

Command Syntax	IEC413:FCURve:LEVel<NRf>
Parameters	15 to 100%
Examples	IEC413:FCURve:LEVel 10
Query Syntax	IEC413:FCURve:LEVel?
Returned Parameters	<NR2>

IEC413:FCURve:DWELI

This command will set the dwell time in seconds for the flat curve test. The class must be selected prior to this command. Query with min and max to find the range of dwell time.

Command Syntax	IEC413:FCURve:DWELI <NRf+>
Parameters	
Examples	IEC413:FCURve:DWEL 20
Query Syntax	IEC413:FCURve:DWEL?
Returned Parameters	<NR1>

IEC413:FCURve:PAUSE

This command will set the pause time in seconds. This is the time between tests when RUN:ALL is selected. The class must be selected prior to this command. Query with min and max to find the range of the dwell time.

Command Syntax	IEC413:FCURve:PAUSE <NRf+>
Parameters	
Examples	IEC413:FCURve:PAUS 2
Query Syntax	IEC413:FCURve:PAUS?
Returned Parameters	<NR1>

IEC413:MCURve:LEVel

This command will set the levels for the meister curve test. The class must be set prior to this command. The IEC413:STATe must be in the off position and the user class must be selected to accept the command. The command will accept a sequence of five data level parameters. The first two have a range for 0 to 20. These two parameters set the test level in % for the frequency range 0.33 to 2 x f1 and 2 to 10 x f1 respectively. The last three parameters set the test levels for 10 to 20 x f1 and 20 to 40 x f1 in n/f. These values for n can be up to 10,000. All are expressed in % of U1. Note that the IEC 61000-4-13 shows only two frequency ranges in the Meister curve table but the -413 option separates the third range in two ranges resulting in 5 instead of 4 parameters. Set both parameter 3 and 4 to the same value to match the IEC standard table. (See table for reference).

IEC	Frequency Range	Class X Test Levels	-413 Option	Frequency Range	Class X Test Levels
	0.33xf1 to 2xf1	Open		0.33xf1 to 2xf1	Parameter 1
	2xf1 to 10xf1	Open		2xf1 to 10xf1	Parameter 2
	10xf1 to 20xf1	Open		10xf1 to 15xf1	Parameter 3
				15xf1 to 20xf1	Parameter 4
	20xf1 to 40xf1	Open		20xf1 to 40xf1	Parameter 5

Command Syntax	IEC413:MCURve:LEVel<NRf>
Parameters	0 to 20, 0 to 10,000
Examples	IEC413:MCURve:LEVel 10,5,4500,4500,5000
Query Syntax	IEC413:MCURve:LEVel?
Returned Parameters	<NR2>

IEC413:MCURve:DWELI

This command will set the dwell time in seconds for the meister curve test. The class must be selected prior to this command. Query with min and max to find the range of dwell time. The default is 10 seconds. This value may not be enough to cover the 5 minutes required by the test for each range. The user must coordinate the step size with the dwell time to generate the test period for each frequency range.

Command Syntax	IEC413:MCURve:DWELI <NRf+>
Parameters	
Examples	IEC413:MCURve:DWEL 20
Query Syntax	IEC413:MCURve:DWEL?
Returned Parameters	<NR1>

IEC413:MCURve:PAUSE

This command will set the pause time in seconds. This is the time between tests when RUN:ALL is selected. The class must be selected prior to this command. Query with min and max to find the range of the dwell time. When the selected GROUP is MCURve, the pause should normally be set to 0 as no pause is required for this test. If a pause value other than zero is set, the interharmonic levels during the pause period will be zero.

Command Syntax	IEC413:FCURve:PAUSE <NRf+>
Parameters	
Examples	IEC413:FCURve:PAUS 2
Query Syntax	IEC413:FCURve:PAUS?
Returned Parameters	<NR1>

IEC413:OSWing:LEVel

This command will set the level for the 'over swing' harmonics combination test. The command has two parameters, one for the third and one for the fifth order harmonic. The IEC413:STATe must be in the off position and the user class must be selected to accept the command.

Command Syntax	IEC413:OSWing:LEVel <NRf+>,<NRf>
Parameters	0 to 20%
Examples	IEC413:OSWing:LEVel 10
Query Syntax	IEC413:OSWing:LEVel?
Returned Parameters	<NR2>

IEC413:OSWing:DWELI

This command will set the dwell time in seconds for the over swing harmonics combination test. The class must be selected prior to this command. Query with min and max to find the range of the dwell time.

Command Syntax	IEC413OSWing:DWELI <NRf+>
Parameters	
Examples	IEC413:OSWing:DWEL 10
Query Syntax	IEC413:OSWing:DWEL?
Returned Parameters	<NR1>

IEC413:OSWing:PAUSE

This command will set the pause time in seconds. This is the time between tests when RUN:ALL is selected. The class must be selected prior to this command. Query with min and max to find the range of the pause time.

Command Syntax	IEC413:OSWing:PAUSE <NRf+>
Parameters	
Examples	IEC413:OSWing:PAUS 2
Query Syntax	IEC413:OSWing:PAUS?
Returned Parameters	<NR1>

IEC413:SWEep:LEVel

This command will set the level for the harmonics sweep test. The command will accept either one parameter or five parameters. In case of one parameter, the level will be set for the selected range only. The IEC413:STATe must be in the off position and the user class is selected to accept the command.

Command Syntax	IEC413:SWEep:LEVel <NRf>[,<NRf1.. NRf4>
Parameters	0 to 20%
Examples	IEC413:SWE:LEVel 10
Query Syntax	IEC413:SWE:LEVel?
Returned Parameters	<NR2>

IEC413:SWEep:DWELI

This command will set the dwell time in seconds for the entire sweep range. The class must be selected prior to this command. Query with min and max to find the range of dwell time.

Command Syntax	IEC413:SWEep:DWELI <NRf+>
Parameters	<nrf>
Examples	IEC413:SWE:DWEL 200
Query Syntax	IEC413:SWE:DWEL?
Returned Parameters	<NR1>

IEC413:SWEep:CURREnt[:DATA]?

This command will return the measured harmonic current. This data is available after the sweep is completed.

Command Syntax	IEC413:SWEep:CURREnt[:DATA]]?
Parameters	none
Query Syntax	IEC413:SWE:CURR?
Returned Parameters	<NR2>,... ,<NRn>

IEC413:SWEep:FREQuency[:DATA]?

This command will return the frequency data points that correspond to the harmonic current data points. This data is available after the sweep is completed.

Command Syntax	IEC413:SWEep:FREQuency?
Parameters	none
Query Syntax	IEC413:SWE:CURR:FREQ?
Returned Parameters	<NR2>,... ,<NRn>

IEC413:SWEep:CURRent:RESonant?

This command will return the measured harmonic resonant current. This data is available after the sweep is completed. If no resonant current is found, the command will return a null char.

Command Syntax	IEC413:SWEep:CURRent:RESonant?
Parameters	none
Query Syntax	IEC413:SWE:CURR:RES?
Returned Parameters	<NR2>,.... ,<NRn>

IEC413:SWEep:FREQuency:RESonant?

This command will return the frequency resonant data points that correspond to the harmonic current data points. This data is available after the sweep is completed. If no resonant current is found, the command will return a null char.

Command Syntax	IEC413:SWEep:CURRent:RESonant?
Parameters	none
Query Syntax	IEC413:SWE:FREQ:RES?
Returned Parameters	<NR2>,.... ,<NRn>

IEC413:HARMonics:LEVel

This command will set the level for the harmonics test. The command will accept either one parameter or a sequence of parameters from the second harmonic to the fortieth harmonic. In case of one parameter, the level will be set for the selected harmonic number specified by IEC413:INDV:HARM:NUMBer. The IEC413:STATe must be in the off position and the user class must be selected to accept the command.

Command Syntax	IEC413:HARMonics:LEVel <Nrf+> [,<Nrf>,....<Nrfn>]
Parameters	0 to 20%
Examples	IEC413:HARM:LEV 4,5,.....,8
Query Syntax	IEC413:HARM:LEV?
Returned Parameters	<NR2>,....,<NR2>

IEC413:HARMonics:PHASe

This command will set the phase angle of the harmonics wave form relative to the fundamental. The command will accept either one parameter or a sequence of parameters from the second harmonic to the fortieth harmonic. In case of one parameter, the phase will be set for the selected harmonic number specified by IEC413:INDV:HARM:NUMB. The IEC413:STATe must be in the off position and the user class must be selected to accept the command.

Command Syntax	IEC413:HARMonics:PHASe <Nrf+> [,<Nrf>,....<Nrfn>]
Parameters	0 to 360
Examples	IEC413:HARM:PHAS 180,270,.....,90
Query Syntax	IEC413:HARM:PHAS?
Returned Parameters	<NR2>,....,<NR2>

IEC413:HARMonics:TABLE

This command allows selection of only one of the Individual harmonics tables of the IEC 61000-4-13 standard. Default is to run all tables but some EUT's for class 3 may require only Table 1 to be run. Available selections are Table 1, 2, 3 or all tables.

Command Syntax	IEC413:HARMonics:TABLE <CRD>
Parameters	1 2 3 ALL
Examples	IEC413:HARM:TAB ALL
Query Syntax	IEC413:HARM:TAB?
Returned Parameters	<CRD>

IEC413:HARMonics:DWELI

This command will set the dwell time in seconds for each harmonic. The class must be selected prior to this command. Query with min and max to find the range of the dwell time.

Command Syntax	IEC413:HARM:DWELI <NRf+>
Parameters	<seconds>
Examples	IEC413:HARM:DWEL 10
Query Syntax	IEC413:HARM:DWEL?
Returned Parameters	<NR1>

IEC413:HARMonics:PAUSE

This command will set the pause time in seconds. This is the time between each harmonic. The class must be selected prior to this command. Query with min and max to find the range of the dwell time.

Command Syntax	IEC413:HARM:PAUSE <NRf+>
Parameters	<seconds>
Examples	IEC413:HARM:PAUS 2
Query Syntax	IEC413:HARM:PAUS?
Returned Parameters	<NR1>

IEC413:IHARMonics:LEVel

This command will set the level for the interharmonics test. The command will accept either one parameter or five parameters. In case of one parameter, the level will be set for the selected range only. The IEC413:STATe must be in the off position and the user class must be selected to accept the command.

Command Syntax	IEC413:IHARmonics:LEVel <NRf>[,<NRf1.. NRf4>]
Parameters	0 to 20%
Examples	IEC413:IHAR:LEV 10
Query Syntax	IEC413:IHAR:LEV?
Returned Parameters	<NR2>

IEC413:IHARmonics:DWELI

This command will set the dwell time in seconds for each interharmonics frequency. The class must be selected prior to this command. Query with min and max to find the range of the dwell time.

Command Syntax	IEC413: IHARmonics:DWELI <NRf+>
Parameters	<seconds>
Examples	IEC413:IHAR:DWEL 15
Query Syntax	IEC413:IHAR:DWEL?
Returned Parameters	<NR1>

IEC413:IHARmonics:PAUSe

This command will set the pause time in seconds between each interharmonics frequency. The class must be selected prior to this command. Query with min and max to find the range of the pause time.

Command Syntax	IEC413: IHARmonics:PAUSe <NRf+>
Parameters	<seconds>
Examples	IEC413:IHAR:PAUS 2
Query Syntax	IEC413:IHAR:PAUS?
Returned Parameters	<NR1>

8.3.2 Interharmonics Subsystem

The following commands are used to enable and generate an interharmonic waveform up to 20% of the programmed voltage value.

[:SOURce]		
:IHARmonics		
[:STATe]		Enable or disable the interharmonics generator.
:COUPle		Couple the interharmonics reference to program
volt.		
:FREQuency		Set the interharmonics frequency.
:REFerence		Set the interharmonics reference.
:VOLTage		Set the interharmonics output as % of reference.

[:SOURce]:IHARmonics[:STATe]

This command enables the interharmonics generator. This command must be set to the on state before sending any other command listed in this section.

Command Syntax	[:SOURce]:IHARmonics:STATe <boolean>
Parameters	<ON OFF 1 0 >
Examples	IHAR ON
Query Syntax	IHAR?
Returned Parameters	<boolean>

[:SOURce]:IHARmonics:COUPle

If this command is turned on, the reference voltage for the interharmonics is programmed to a value equal to the ac program value. If the coupling is turned off, the reference voltage must be programmed to a value between 0 and 250V.

Command Syntax	[:SOURce]:IHARmonics:COUPle <boolean>
Parameters	<ON OFF 1 0 >
Examples	IHAR:COUP ON
Query Syntax	IHAR:COUP?
Returned Parameters	<boolean>

[:SOURce]:IHARmonics:FREQuency

This command will program the inter harmonic frequency. This frequency may range from 1Hz to 2400Hz with 1Hz resolution.

Command Syntax	[:SOURce]:IHARmonics:FREQuency <NRf>
Parameters	<frequency >
Examples	IHAR:FREQ 400
Query Syntax	IHAR:FREQ?
Returned Parameters	<NR1>

[[:SOURce]:IHARmonics:REFerence

This command will program the inter harmonic reference voltage. The coupling must be set to on to accept any program value. The reference will take a value of 0 to 250V.

Command Syntax	[[:SOURce]:IHARmonics:REFerence <NRf>
Parameters	<reference>
Examples	IHAR:REF 230
Query Syntax	IHAR:REF?
Returned Parameters	<NR1>

[[:SOURce]:IHARmonics:VOLTage

This command will program the interharmonic voltage as a percentage of the reference voltage. It will accept a value from 0 to 20%.

Command Syntax	[[:SOURce]:IHARmonics:VOLTage <NRf>
Parameters	<voltage>
Examples	IHAR:VOLT 10
Query Syntax	IHAR:VOLT?
Returned Parameters	<NR1>

8.4 RTCA/DO-160D (-160)

The -160 option is implemented through the CSWGui Windows software provided with each AC power source. As such, there are no SCPI commands that apply to the -160 option and they cannot be executed from the front panel or using any SCPI bus commands.

8.5 MIL-STD 704E (-704)

The -704 option is implemented through the CSWGui Windows software provided with each AC power source. As such, there are no SCPI commands that apply to the -704 option and they cannot be executed from the front panel or using any SCPI bus commands.

8.6 Airbus ABD0100.1.8 Test Option (-ABD)

The -ABD option is implemented through the CSWGui Windows software provided with each AC power source. As such, there are no SCPI commands that apply to the -ABD option and they cannot be executed from the front panel or using any SCPI bus commands.

8.7 Airbus A350 ABD0100.1.8.1 Test Option (-A350)

The -A350 option is implemented through the CSWGui Windows software provided with each AC power source. As such, there are no SCPI commands that apply to the -A350 option and they cannot be executed from the front panel or using any SCPI bus commands.

8.8 Airbus AMD24 Test Option (-AMD)

The -AMD option is implemented through the CSWGui Windows software provided with each AC power source. As such, there are no SCPI commands that apply to the -AMD option and they cannot be executed from the front panel or using any SCPI bus commands.

8.9 Boeing B787-0147 Test Option (-B787)

The -B787 option is implemented through the CSWGui Windows software (version 2.1.0.0 or higher) provided with each AC power source. As such, there are no SCPI commands that apply to the -B787 option and they cannot be executed from the front panel or using any SCPI bus commands.

8.10 Watt Hour Meter (-WHM)

The following SCPI command may be used to control the Watt Hour Meter functions if the -WHM option is installed:

Subsystem Syntax

WHMeter:

[STATe]	Turn on or off the watt-hour function
ETIMe?	Returns the elapsed time
WHOur?	Returns the watt-hour measurement data in KWH

WHMeter[:STATe]

This command will start or stop the watt-hour function.

Command Syntax	WHMeter[:STATe]<bool>
Parameters	0 OFF 1 ON
Examples	WHM ON
Query Syntax	WHM[:STATe]?
Returned Parameters	0 1

WHMeter:ETIMe?

This command will return the total amount of time the watt-hour meter has accumulated. The returned data has four fields separated by commas. These fields are hours, minutes, seconds and milliseconds.

Command Syntax	WHMeter:ETIMe?
Parameters	none
Query Syntax	WHM:ETIM?
Returned Parameters	h,mm,ss,ms

WHMeter:WHOur?**Phase Selectable**

This command will return the total accumulated kilowatt-hours for the selected phase. If coupling is set to "all", the value returned is the sum of all phases in the system regardless of the selected phase.

Command Syntax	WHMeter:WHOur?
Parameters	none
Query Syntax	WHM:WHO?
Returned Parameters	<numeric value>

Note: *If the watt-hour meter is active, the total power of all phases in the system will be returned when querying the power.*

Appendix A: SCPI Command tree

The following command tree contains all the supported standard commands for the CSW Series AC/DC source. Some command listed may not apply to a specific CSW Series model or controller version. Check the relevant reference section for specific details on using each of these commands.

ABORT

CALibration

```

..... IHARmonics?
..... MEASURE
..... CURRent
..... [AMBient]
..... [AC]
..... FSCALe
..... DC
..... [FSCALe]
..... ZERO
..... TEMP
..... [AC]
..... [FSCALE]
..... DC
..... [FSCALe]
..... ZERO
..... VOLTage
..... [AMBient]
..... [AC]
..... FSCALe
..... DC
..... [FSCALe]
..... ZERO
..... TEMP
..... [AC]
..... [FSCALE]
..... DC
..... [FSCALe]
..... ZERO
..... PASSWORD
..... SAVE
..... [SOURce]
..... PHASe
..... VOLTage
..... [AC]
..... LRANGe
..... [FSCale]
..... ZERO
..... HFRequency
..... HRANGe
..... [FSCale]
..... ZERO
..... HFRequency
..... HFRequency
..... DC
..... LRANGe
..... [FSCale]
..... [POSitive]
..... NEGative

```

.....ZERO
HRANGe
[FSCale]
[POSitive]
NEGative
ZERO

INITiate

.....[IMMEDIATE]
 [TRANsient]
 ACQuire
CONTInuous ON | OFF

INSTRument

.....COUPlE ALL | NONE
NSElect 1 | 2 | 3
SElect A | B | C

MEASure | FETCh

.....ARRAY
 CURRent
 [DC]?
 HARMonic
 [AMPLitude]?
 PHASe
 MODE
 VOLTage
 [DC]?
 HARMonic
 [AMPLitude]?
 PHASe
 [SCALar]
 CURRent
 [AC]?
 DC?
 AMPLitude
 MAX?
 RESet
 CREStfactor?
 HARMonic
 [AMPLitude]? <n>
 PHASe? <n>
 THD?
 FREQuency?
 PHASe?
 POWer
 [AC]
 [REAL]?
 APParent?
 PFActor?
 DC?
 VOLTage
 [AC]?
 DC?
 HARMonic
 [AMPLitude]? <n>
 PHASe? <n>

..... THD?

OUTPut

.....[STATe] <bool>
IMMediate <bool>
PROT:PROT:CLE
RI
 [LEVe] HIGH | LOW
 :MODE LATC | LIVE | OFF
 TTLTrg
 [STATe] <bool>
 SOURce <source>

SENSe

.....SWEep
 OFFSet <n>
 TINTerval?

[SOURce]

.....CURRent
 [LEVe]
 [IMMediate]
 [AMPLitude]
 PROTection
 STATe
 DELay
 FREquency
 [IMMediate]
 MODE
 TRIGgered
 SLEW
 [IMMediate]
 MODE
 TRIGgered
 FUNctIon
 [SHAPe]
 [IMMediate]
 CSINe <n>
 MODE
 LIMit
 FREquency <n1>,<n2>
 VOLTage <n1>,<n2>,<n3>
 CURRent <n>
 PHASe <n>
 LIST
 COUNT <n>|MAX
 CURRent <n>,<n>
 POINTs?
 DWELI <n>,<n>
 POINTs?
 FREquency
 [LEVe] <n>,<n>
 POINTs?
 [SLEW] <n>,<n>
 POINTs?
 FUNctIon
 [SHAPe] <shape>,<shape>

```

.....POINTs?
.....REPeat
.....[COUnT] <n>,<n>
.....POINTs?
.....STEP ONCE|AUTO
.....TTLTrg <bool>,<bool>
.....POINTs?
.....VOLTage
.....[LEVel] <n>,<n>
.....POINTs?
.....SLEW <n>,<n>
.....POINTs
.....MODE
.....PHASe
.....[IMMediate] <n>
.....PONSetup
.....ALControl 0|1|OFF|ON
.....CLOCK INT | EXT
.....CURRent <n>
.....FREQuency <n>
.....NOUTPUT ONE|THR|LAST
.....OUTPUT
.....[RELay] 0|1|ON|OFF
.....OLOad
.....[MODE] CVOLT | CCURR
.....PHASe
.....[ANGLE] <n>
.....SENSe INT | EXT
.....VOLTage
.....[LEVel] <n>
.....MODE AC|DC|ACDC
.....VRANGE 135|270 150|300
.....WGRoup <n>
.....PULSe
.....COUNT <n>| MAXimum
.....DCYCLE <n>
.....HOLD WIDTH|DCYCLE
.....PERiod <n>
.....WIDTH <n>
.....VOLTage
.....ALC ON | OFF
.....[LEVel]
.....[IMMediate]
.....[AMPLitude]
.....[AC] <n>
.....DC <n>
.....OFFset <n>
.....MODE <mode>
.....TRIGgered
.....[AMPLitude] <n>
.....MODE
.....RANGe
.....[LEVel] <n>
.....SENSe
.....[SOURce] INTernal | EXTernal
.....SLEW

```

..... [IMMediate] <n> | MAXimum
 MODE <mode>
 TRIGgered
 [AMPLitude] <n> | MAXimum

STATus

..... OPERation
 EVENT
 CONDition
 ENABLE <n>
 QUEStionalbe
 EVENT
 CONDition
 ENABLE <n>
 INSTRuments
 ISUMmary
 EVENT
 CONDition
 ENABLE <n>

SYSTEM

..... ERRor?
 VERSion?
 LOCal
 REMote
 CONFigure
 [BYTE]
 NOUT
 ETIMe?
 TEMPerature?
 COMMunicate
 GPIB
 ADDRess
 SERial
 BUAD
 PARity
 BITS
 SBITS

TRACe

..... CATalog?
 [DATA] <waveform_name>, <n>,...<n>
 DEFine <waveform_name>[,<waveform_name>|1024]
 DELete
 [NAME] <waveform_name>
 ALL

TRIGger

..... [TRANsient]
 SOURce IMMEDIATE | BUS
 COUNT NONE | ALL
 ACQUIRE
 SOURce IMMEDIATE | BUS | TTLTrg
 SYNChronize
 SOURce IMMEDIATE | PHAS
 PHASe <n>
 STATE?

Note: Available option SCPI commands are not listed in this table. See option section for details on specific installed options and their relevant SCPI commands.

Appendix B: SCPI Conformance Information

SCPI Version

The CSW Series AC/DC power sources conform to SCPI version 1995.0.

Appendix C: Error Messages

Any errors that occur during operation from either the front panel or the remote control interface will result in error messages. Error messages are displayed in the upper left hand corner of the LCD display. They are also stored in the error message queue from which they can be queried using the SYST:ERR? Query. The error queue has a finite depth. If more error messages are generated than can be held in the queue, a queue overflow message will be put in the last queue location. To empty the queue, use the error query until the No Error result is received.

Errors appearing on the LCD will generally remain visible until the user moves to another screen. If multiple error messages are generated in succession, only the last message will be visible as there is only space for one error message on the LCD display.

The same area of the display is also used to display status messages. While error messages always have a negative error number, status messages have a positive number.

The table below displays a list of possible error and status messages along with their possible cause and remedy.

Number	Message String	Cause	Remedy
0	"No error"	No errors in queue	
-100	"Command error"	Unable to complete requested operation	Unit may be in a mode inconsistent with request.
-102	"Syntax error"	Command syntax incorrect.	Misspelled or unsupported command
-103	"Invalid separator"	SCPI separator not recognized	See SCPI section of programming manual.
-104	"Data type error"	Data type invaled.	Check command for supported data types
-108	"Parameter not allowed"	One or more additional parameters were received.	Check programming manual for correct number of parameters
-109	"Missing parameter"	Too few parameters received for requested operation	Check programming manual for correct number of parameters
-110	"Command header error"	Command header incorrect	Check syntax of command.
-111	"header separator error"	Invalid command separator used.	Use semi-colon to separate command headers
-112	"Program mnemonic too long"	Syntax error	Check programming manual for correct command syntax
-113	"Undefined header"	Command not recognized error	Check programming manual for correct command syntax
-120	"Numeric data error"	Data received is not a number	Check programming manual for correct command syntax
-121	"Invalid character in number"	Number received contains non-numeric character(s)	Check programming manual for correct command syntax
-123	"Exponent too large"	Exponent in number exceeds limits	Check programming manual for correct parameter range
-128	"Numeric data not allowed"	Number received when number is not allowed.	Check programming manual for correct command syntax

Number	Message String	Cause	Remedy
-168	"Block data not allowed"	Block data was sent.	Check programming manual for correct command syntax
-200	"Execution error"	Command could not be executed	Command may be inconsistent with mode of operation such as programming frequency when in DC mode.
-201	"Invalid while in local"	Command issued but unit is not in remote state	Put instrument in remote state before issuing GPIB commands.
-203	"Command protected"	Command is locked out	Some commands are supported by the unit but are locked out for protection of settings and are not user accessible.
-210	"Trigger error"	Problem with trigger system.	Unit could not generate trigger for transient execution or measurement.
-211	"Trigger ignored"	Trigger request has been ignored.	Trigger setup incorrect or unit was not armed when trigger was received. Check transient system or measurement trigger system settings.
-213	"Init ignored"	Initialization request has been ignored	Unit was told to go to armed state but was unable to do so. Could be caused by incorrect transient system or measurement acquisition setup.
-220	"Parameter error"	Parameter not allowed.	Incorrect parameter or parameter value. Check programming manual for allowable parameters
-221	"Setting conflict"	Requested setting conflicts with other setting in effect.	Check other settings. E.g. trying to program a DC offset while in AC mode
-222	"Data out of range"	Parameter data outside of allowable range.	Check programming manual for allowable parameter values
-223	"Too much data"	More data received than expected	Check programming manual for number of parameters or data block size
-224	"Illegal parameter value"	Parameter value is not supported	Check programming manual for correct parameters
-226	"Lists not same length"	One or more transient lists programmed has different length.	All lists must be of same length or transient cannot be compiled and executed.
-241	"Hardware missing"	N/A	N/A
-254	"Media full"	No storage space left to save settings or data.	Delete other settings or data to make room.
-255	"Directory full"	Too many waveform directory entries	Delete one or more waveforms from waveform memory to make room.
-256	"File name not found"	Waveform requested not in directory	Check waveform directory for waveform names present.
-257	"File name error"	Incorrect filename	Too many or non ASCII characters used in waveform file definition.
-283	"Illegal variable name"	Variable name illegal.	Use ASCII characters only

Number	Message String	Cause	Remedy
-300	"Device specific error"	<p>Possible causes are:</p> <ol style="list-style-type: none"> 1. Attempt to program a frequency while source is in DC mode. 2. Attempt to set initial voltage mode to AC+DC. 3. Attempt to program AC voltage while in DC mode. 4. Attempt to program DC voltage while in AC mode. 5. Attempt to program voltage offset while in DC or AC mode only. 6. Attempt to change sense mode while the output relay is on. 7. Attempt to change the voltage mode to DC while iec413 or iec411 state is on. 8. Attempt to change the voltage mode to DC while in external sync or clock mode. 9. Attempt to change mode to AC+DC without the ADV option present (see *OPT?). 10. Attempt to use the phase angle trigger while iec411 state is on. 	Check for proper mode or command sequence operation.
-311	"Memory error"	Waveform memory checksum error.	<p>May be the result of incomplete user-defined waveform download. Check interface and try downloading waveform again. Successful download may clear this error condition.</p> <p>Alternatively, use TRAC:DEL:ALL command to clear waveform memory. (Fw 0.16 and higher)</p>
-314	"Save/recall memory lost"	User setup register contents lost	Store setup in same register again.
-315	"Configuration memory lost"	Hardware configuration settings lost.	Contact CI service department at support@programmablepower.com to obtain instructions on restoring configuration data.
-330	"Self-test failed"	Internal error	Contact CI service department at support@programmablepower.com
-350	"Queue overflow"	Message queue full.	Too many messages. Read status using SYST:ERR query until 0, "No

Number	Message String	Cause	Remedy
			Error" is received indicating queue empty.
-400	"Query error"	Unable to complete query.	Check programming manual for correct query format and parameters
-410	"Query INTERRUPTED"	Query issued but response not read.	Check application program for correct flow. Response must be read after each query to avoid this error.
-420	"Query UNTERMINATED"	Query incomplete.	Check for terminator after query command.
-430	"Query DEADLOCKED"	Query cannot be completed	Check application program for multiple queries
-440	"Query UNTERMINATED"	Query incomplete.	Check for terminator after query command.
1	"Output volt fault"	Output voltage does not match programmed value.	Load exceeds current limit and unit is in Constant Voltage (CV) mode of operation. Reduce load or increase CL setting Output voltage is driven above programmed voltage by external influence (Load, voltage kickback, etc.)
2	"Current limit fault"	Current limit exceeded.	Load exceeds current limit and unit is in Constant Voltage (CV) mode of operation. Reduce load or increase CL setting
3	"Temperature fault"	Temperature of heat sink too high.	Reduce load. Ensure proper air flow and exhaust clearance. Check fan(s) for operation.
4	"External sync. error"	Could not sync to external sync signal.	External sync signal missing, disconnected or out of range.
5	"Initial memory lost"	Power on settings could not be recalled.	Save power on settings again to overwrite old content.
6	"Limit memory lost"	Hardware configuration settings lost.	Contact CI service department at support@programmablepower.com to obtain instructions on restoring configuration data.
7	"System memory lost"	Memory corrupted.	Recycle power.
8	"Calibration memory lost"	Calibration data lost.	Contact CI service department at support@programmablepower.com to obtain instructions on restoring calibration data or reCALibration unit.
9	"Start angle must be first sequence"	Start phase angle in wrong place..	Start phase angles can only be programmed at the start of a transient list. Once a transient is in progress, phase angle cannot be changed.
10	"Illegal for DC"	Operation not possible in DC mode.	Switch to AC or AC+DC mode.
11	"Duplicate sequence"	Transient list sequence number already used.	User new or available sequence number instead.

Number	Message String	Cause	Remedy
12	"Too many sequence"	Number of transient list steps exceeds maximum.	Reduce the number of steps in the transient list. (Max = 100).
13	"Missing list parameter"	One or more transient list parameters missing.	Check programmed lists.
14	"Voltage peak error "	Peak voltage exceeds internal bus voltage	This error may occur when selecting user defined wave shapes with higher crest factors. Reduce programmed RMS value.
15	"Slew time exceed dwell"	Time needed to slew to final value is less than dwell time.	Check dwell times in transient list settings. Increase dwell time or change slew rate for affected parameter.
16	"Illegal during transient"	Operation requested not available while transient is running.	Wait till transient execution is completed or abort transient execution first.
17	"Output relay must be closed"	Operation not possible with open relay	Close relay before attempting operation. E.g. transient execution requires output relay to be closed.
18	"Trans. duration less than 1msec"	Dwell time below minimum or 1 msec	Increase dwell time to at least 1 msec.
19	"Clock and sync must be internal"	Operation not possible with external clock	Switch to internal sync. (Default)
20	"Input buffer full"	Too much data received.	Break up data in smaller blocks.
21	"EOS Fault"	Hardware error reported by EOS option	Cycle power on EOS to reset error. If error persist, contact Contact CI service department at support@programmablepower.com for repair.
22	"Waveform harmonics limit"	Harmonic contents of user defined wave shape is too high and could damage amplifier output stage.	Reduce harmonic content or reduce fundamental frequency programmed.
23	"ALC must be off"		
24	"Output relay must be open"	Attempting to change voltage range while output relay is closed.	Open output relay first, then change range. This ensures the load is physically disconnected during voltage range change.
25	"Over voltage prot trip"	Over voltage protection trip.	Output voltage exceeds voltage range value. Check sense connections if external sense mode is used.
26	"Peak curr prot trip"	Maximum available peak current capability of power source exceeded. Note: Firmware rev 4.52 or higher.	This error will trip if PONS:CURR:PEAK:PROT status is set to 1 and the peak current drawn by the load exceeds the maximum specified peak current capability for more than 30 seconds. To avoid this error, reduce the load on the power

Number	Message String	Cause	Remedy
			source or upgrade to a larger power configuration.
27	"Frequency error"	Frequency is out of allowable range.	Indicates a problem with programmable controller.
28	"Phase error"	Incorrect phase	
29	"DC component exceeds limit"	The waveform selected contains a DC offset that exceeds the AC mode capability.	Select AC+DC mode.
30	"Amplifier fault"	Amplifier fault.	Contact customer service.
31	"Warning negative power near limit"	Approaching limit on the amount of power that can be fed back into the supply by an active load. This is a warning only.	Stop increasing power feedback into the power supply. Typically occurs when using AC inverters. If power increases further, an error 32 will be generated.
32	"Negative power fault"	Too much power fed back. Power source output disconnected.	Reduce the amount of power being fed back into the power source.

Table 8-4 : Error Messages

Index

*	
*CLS	124
*ESE	125
*ESR?	125
*IDN?	126
*OPC	126
*OPT?	127
*PSC	129
*RCL	129
*RST	130
*SAV	131
*SRE	131
*STB?	132
*TRG	133
*WAI	133
I	
[:SOURce]:IHARmonics:COUPlE	181
[:SOURce]:IHARmonics:FREQUency	181
[:SOURce]:IHARmonics:REFerence	182
[:SOURce]:IHARmonics:STATe	181
[:SOURce]:IHARmonics:VOLTage	182
4	
411 Option	166
413 Option	170
A	
A350 option	
commands	184
ABD option	
commands	184
ABORT	118
address	
IEEE	11
Agilent 82350	21
AMD option	
commands	184
B	
B787 option	
commands	184
C	
CALibrate:MEASure:CURRent[:AMBient] [:AC][:FSCale] <NRf>	41
CALibrate:MEASure:CURRent[:AMBient]:DC[:FSCale] <NRf>	41
CALibrate:MEASure:VOLTage[:AMBient]:DC[:FSCale] <NRf>	41
CALibrate:MEASure:VOLTage[:AMBient][:AC][:FSCale] <NRf>	41
CALibrate:PASSword	40
CALibrate:SAVE	40
CALibrate[:SOURce]:VOLTage:DC:HRANge:ZERO <NRf+>	45
CALibrate[:SOURce]:VOLTage:DC:HRANge[:FSCale] <NRf+>	45

CALibrate[:SOURce]:VOLTage:HFRequenc	45
CALibrate[:SOURce]:VOLTage[:AC]:HRANge[:FSCale] <NRf+>	44
CALibrate[:SOURce]:VOLTage[:AC]:LRANge[:FSCale] <NRf+>	43
command	
subsystem.....	37
commands	
common	16
Conventions	13
CURRent	73
CURRent:PROTection:STATe	74
D	
DISPlay:LOCation	47
DISPlay:MODE	46
DISPlay:STATe	46
DISPlay:TEXT	47
E	
Error Handling	21
error messages	193
Ethernet.....	34
Ext. Trigger.....	71
F	
FETCh:ARRay:CURRent:HARMonic:PHASe?	52
FETCh:ARRay:CURRent?	51
FETCh:ARRay:VOLTage:HARMonic:PHASe?	55
FETCh:ARRay:VOLTage:HARMonic?	55
FETCh:ARRay:VOLTage?	55
FETCh:CURRent:AC?	57
FETCh:CURRent:AMPLitude:MAXimum?	58
FETCh:CURRent:CREStfactor?	59
FETCh:CURRent:HARMonic:PHASe?	60
FETCh:CURRent:HARMonic:THD?	60
FETCh:CURRent:HARMonic?	59
FETCh:CURRent?	58
FETCh:POWer:DC?	64
FETCh:POWer[:AC]:APParent?	63
FETCh:POWer[:AC]:PFACtor?	64
FETCh:VOLTage:AC?	65
FETCh:VOLTage:HARMonic:PHASe?	66
FETCh:VOLTage:HARMonic:THD?	67
FETCh:VOLTage:HARMonic?	66
FETCh:VOLTage?	65
firmware	
updates	11, 12
format	
waveform data	53
formats	
data	20
FREQuency:SLEW:TRIGgered	77
FREQuency	75
FREQuency:MODE	75
FREQuency:SLEW	76
FREQuency:SLEW:MODE	76
FREQuency:TRIGgered	77

FUNction.....	78
Function Strobe	71
FUNction:CSINe	79
FUNction:MODE.....	79
G	
GPIB controllers	21
H	
header	
optional	18
separator.....	18
Header	14
optional	15
I	
IEC411:STATe	168
IEC413: IHARmonics:DWELI	179
IEC413: IHARmonics:PAUSe	180
IEC413:CLASs	171
IEC413:FCURve:DWELI	173
IEC413:FCURve:LEVel.....	173
IEC413:FCURve:PAUSe.....	173, 175
IEC413:GROup	173
IEC413:HARM:DWELI.....	178
IEC413:HARM:PAUSe	178
IEC413:HARMonics:LEVel.....	177
IEC413:HARMonics:PHASe.....	177
IEC413:HARMonics:TABLE.....	178
IEC413:IHARmonics:LEVel.....	178
IEC413:INDVidual:HARMonics[:NUMBer]	172
IEC413:INDVidual:IHARMonics[:FREQUency]	172
IEC413:INDVidual:SWEEp[:RANGe]	172
IEC413:MCURve:DWELI.....	174
IEC413:MCURve:LEVel	174
IEC413:OSWing:LEVel	175
IEC413:OSWing:PAUSe	175
IEC413:PAUSe.....	171
IEC413:RUN.....	171
IEC413:STATe	171
IEC413:STEP[:SIZE]	172
IEC413:SWEEp:CURRent:RESonant?	177
IEC413:SWEEp:CURRent[:DATA]	176
IEC413:SWEEp:DWELI.....	176
IEC413:SWEEp:FREQUency?	176
IEC413:SWEEp:LEVel.....	176
IEC413O:SWing:DWELI.....	175
IEEE	11
setting address	11
IEEE-488	10
INITiate:ACQuire	119
INITiate:CONTInuous	119
INITiate{:IMMEDIATE[:TRANsient]}	119
INSTrument:COUPle.....	48
INSTrument:NSElect.....	48
INSTrument:SElect	49

IP address 34

L

LAN

connector 34

MAC Address 34

LAN Option

IP address..... 34

Port number 36

LIMit:CURRent 80

LIMit:FREQuency 80

LIMit:PHASe 81

LIMit:VOLTagE 80

LIST:COUNT 85

LIST:DWELl 85

LIST:DWELl:POINts? 85

LIST:FREQuency 86

LIST:FREQuency:POINts? 86

LIST:FREQuency:SLEW 86

LIST:FREQuency:SLEW:POINts? 86

LIST:FUNCTion:POINts? 87

LIST:FUNCTion[:SHAPe] 87

LIST:REPeat:POINts? 88

LIST:REPeat[:COUNt] 88

LIST:STEP 88

LIST:TTLTrg 89

LIST:TTLTrg:POINts? 89

LIST:VOLTagE 90

LIST:VOLTagE:POINts? 90

LIST:VOLTagE:SLEW 90

LIST:VOLTagE:SLEW:POINts? 91

M

MAC Address 34

MEASure:ARRAy:CURRent:HARMonic:PHASe? 52

MEASure:ARRAy:CURRent:HARMonic? 51

MEASure:ARRAy:CURRent? 51

MEASure:ARRAy:MODE 53

MEASure:ARRAy:VOLTagE:HARMonic:PHASe? 55

MEASure:ARRAy:VOLTagE:HARMonic? 55

MEASure:ARRAy:VOLTagE? 55

MEASure:CURRent:AC? 57

MEASure:CURRent:AMPLitude:MAXimum? 58

MEASure:CURRent:AMPLitude:RESet 58

MEASure:CURRent:CREStfactor? 59

MEASure:CURRent:HARMonic:PHASe? 60

MEASure:CURRent:HARMonic:THD? 60

MEASure:CURRent:HARMonic? 59

MEASure:CURRent? 58

MEASure:FREQuency? 61

MEASure:PHASe? 62

MEASure:POWer:AC:APParent? 63

MEASure:POWer:AC:PFACtor? 64

MEASure:POWer:AC? 63

MEASure:POWer:DC? 64

MEASure:VOLTagE:AC? 65

MEASure:VOLTage:HARMonic:PHASe? 66
 MEASure:VOLTage:HARMonic:THD? 67
 MEASure:VOLTage:HARMonic? 66
 MEASure:VOLTage? 65
 MODE 92

N

National Instruments
 PCI-GPIB 21

O

Option
 -411 166
 -413 170
 -A350 184
 -ABD 184
 -AMD 184
 -B787 184

OUTPut
 IMMEDIATE 69
 OUTPut:PROTEction:CLEar 69
 OUTPut:PROTEction:DELay 74
 OUTPut:RI:MODE 70
 OUTPut:RI[:LEVel] 69, 70
 OUTPut:TTLTrg:MODE 71
 OUTPut:TTLTrg:SOURce 71
 OUTPut:TTLTrg[:STATE] 71
 OUTPut[:STATE] 68

P

PHASe 93
 PONSetup:ALControl 94
 PONSetup:CURREnt 95
 PONSetup:FREQuency 95
 PONSetup:OLOad[:MODE] 94, 95
 PONSetup:OUTPut[:RELay] 96
 PONSetup:PHASe[:ANGLE] 96
 PONSetup:VOLTage:MODE 97, 104
 PONSetup:VOLTage[:LEVel] 96
 PONSetup:VRANGE 97

Port number
 TCP/IP 36
 programming 21

PULSe:COUNT 98
 PULSe:DCYCLE 99
 PULSe:HOLD 98
 PULSe:PERiod 99
 PULSe:WIDTH 100

Q

queries 16

R

RJ45
 connector 34
 root 19

Root 14

S

SCPI 13

 message 14

 program message 14

 response message 14

SENSE:SWEEp:OFFSet:POINts 82

SENSE:SWEEp:TINterval 83

Separator 18

STATus:OPERation:CONDition? 107

STATus:OPERation:ENABle 107

STATus:OPERation:EVENT? 107

STATus:QUESTionable:CONDition? 108

STATus:QUESTionable:ENABle 108

STATus:QUESTionable:INSTrument:ISUMmary:CONDition? 109

STATus:QUESTionable:INSTrument:ISUMmary:ENABle 109

STATus:QUESTionable:INSTrument:ISUMmary? 109

STATus:QUESTionable[:EVENT]? 108

SYSTem:COMMunicate:GPIB:ADDReSS 112

SYSTem:COMMunicate:LAN:ADDReSS 112, 113

SYSTem:COMMunicate:LAN:GWADdress 113, 114

SYSTem:COMMunicate:LAN:HBITS 113

SYSTem:COMMunicate:LAN:PORT 114

SYSTem:COMMunicate:SERial:BAUD 115

SYSTem:COMMunicate:SERial:BITS 115

SYSTem:COMMunicate:SERial:PARity 115

SYSTem:COMMunicate:SERial:SBITS 115

SYSTem:CONFigure 111

SYSTem:ERRor? 110

SYSTem:ETIMe? 112

SYSTem:LOCal 111

SYSTem:REMote 111

SYSTem:VERSion? 110

T

Table of Contents 7

TCP/IP

 IP address 34

 Port number 36

terminator 19

TRACe 116

TRACe:CATalog 117

TRACe:DEFine 117

TRACe:DELete 117

TRACe:DELete:ALL 117

TRIG:STATe? 122

Trigger Out 71

 Mode 71, 89, 121, 152, 154

TRIGger:ACQuire:SOURce 121

TRIGger:COUNT 120

TRIGger:SYNChronize:PHASe 121

TRIGger:SYNChronize:SOURce 121

TRIGger[:TRANsient]:SOURce 120

U

USB
 connector 25
 User Manual 10

V

VB sample
 waveform conversion 53
 VOLTage 102
 VOLTage:ALC 101
 VOLTage:MODE 103
 VOLTage:RANGe 103
 VOLTage:SENSe[:SOURce] 104
 VOLTage:SLEW 104
 VOLTage:SLEW:MODE 105
 VOLTage:SLEW:TRIGgered 105
 VOLTage:TRIGgered 102
 VOLTage:XLOAD 105

W

waveform
 data format modes 53
 WHMeter[:ETIMe?] 185
 WHMeter[:STATe] 184
 WHMeter[:WHOur?] 185