



*3300I Series
DC Power Supplies*

**IEEE 488.2
Programming Manual**

Elgar Electronics Corporation
9250 Brown Deer Road
San Diego, CA 92121-2294
1-800-733-5427
Tel: (858) 450-0085
Fax: (858) 458-0267
Email: sales@elgar.com
www.elgar.com

©2002 by PowerTen. This document contains information proprietary to PowerTen. The information contained herein is not to be duplicated or transferred in any manner without prior written permission from PowerTen.

Safety Notice

Before applying power to the system, verify that the unit is configured properly for the user's particular application.

The 3300I series of power supplies is intended for rack mounted application only. Use of the power supplies outside of a rack mount enclosure will expose the user to high voltage and/or high current sources. Extreme caution must be used under these circumstances.

The analog control inputs (connectors J1 and J2) on the rear panel are referenced to the negative output of the power supply. Grounding the positive output of the power supply or biasing the output of the supply above chassis potential will cause these inputs (along with the output of the supply) to have a potentially hazardous offset voltage. Exercise caution under these conditions. Under no circumstances should the output of the supply be biased more than 500 volts from chassis potential.

Installation and service must be performed only by properly trained and qualified personnel who are aware of dealing with attendant hazards. This includes simple tasks such as fuse verification.

Ensure that the AC power line ground is connected properly to the unit input connector or chassis. Similarly, other power ground lines including those to application maintenance equipment must be grounded properly for both personnel and equipment safety.

Always ensure that facility AC input power is de-energized prior to connecting or disconnecting the input/output power cables.

Warning: Lethal voltages may be present inside the power supply even when the AC input voltage is disconnected. Only properly trained and qualified personnel should remove covers and access the inside of the power supply.

During normal operation, the operator does not have access to hazardous voltages within the chassis. However, depending on the user's application configuration, HIGH VOLTAGES HAZARDOUS TO HUMAN SAFETY may be generated normally on the output terminals. Ensure that the output power lines are labeled properly as to the safety hazards and that any inadvertent contact with hazardous voltages is eliminated.

Due to filtering, the unit has high leakage current to the chassis. Therefore, it is essential to operate this unit with a safety ground.

This unit is designed to be permanently connected to the power source and as such must have a readily accessible disconnect device incorporated in the fixed wiring.

After the unit has been operating for some time, the metal near the rear of the unit may be hot enough to cause injury. Let the unit cool before handling.

These operating instructions form an integral part of the equipment and must be available to the operating personnel at all times. All the safety instructions and advice notes are to be followed. Neither Power Ten nor any of the subsidiary sales organizations can accept responsibility for personal, material or consequential injury, loss or damage that results from improper use of the equipment and accessories.

SERVICE SAFETY NOTICES

WARNING!

HAZARDOUS VOLTAGES IN EXCESS OF 480 V RMS, 700 V PEAK MAY BE PRESENT WHEN COVERS ARE REMOVED. QUALIFIED PERSONNEL MUST USE EXTREME CAUTION WHEN SERVICING THIS EQUIPMENT. CIRCUIT BOARDS, TEST POINTS, AND OUTPUT VOLTAGES MAY BE FLOATING ABOVE CHASSIS GROUND.

WARNING!

TO GUARD AGAINST RISK OF ELECTRICAL SHOCK DURING OPEN COVER CHECKS, DO NOT TOUCH ANY PORTION OF THE ELECTRICAL CIRCUITS. EVEN WHEN THE POWER IS OFF, CAPACITORS CAN RETAIN AN ELECTRICAL CHARGE. USE SAFETY GLASSES DURING OPEN COVER CHECKS TO AVOID PERSONAL INJURY BY ANY SUDDEN FAILURE OF A COMPONENT.

WARNING!

SOME CIRCUITS ARE LIVE EVEN WITH THE FRONT PANEL SWITCH TURNED OFF. SERVICE, FUSE VERIFICATION, AND CONNECTION OF WIRING TO THE CHASSIS MUST BE ACCOMPLISHED AT LEAST FIVE MINUTES AFTER POWER HAS BEEN REMOVED VIA EXTERNAL MEANS; ALL CIRCUITS AND/OR TERMINALS TO BE TOUCHED MUST BE SAFETY GROUNDED TO THE CHASSIS.

WARNING!

QUALIFIED SERVICE PERSONNEL NEED TO BE AWARE THAT SOME HEAT SINKS ARE NOT AT GROUND, BUT AT HIGH POTENTIAL.

FCC NOTICE

This equipment has been tested and found to comply with the limits for a Class A digital device, pursuant to part 15 of the FCC Rules. These limits are designed to provide reasonable protection against harmful interference when the equipment is operated in a commercial environment. This equipment generates, uses, and can radiate radio frequency energy and, if not installed and used in accordance with the instruction manual, may cause harmful interference to radio communications. Operation of this equipment in a residential area is likely to cause harmful interference in which case the user will be required to correct the interference at his own expense.

About This Manual

This manual has been written expressly for the Power Ten 3300I Series of power supplies.

SAFETY SYMBOLS

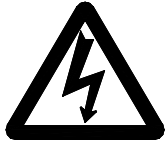

CAUTION
Risk of Electrical Shock

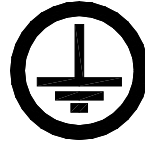

Protective Conductor Terminal



CAUTION
Refer to Accompanying Documents



Alternating Current (AC)

TABLE OF CONTENTS

Chapter 1 DESCRIPTION OF EQUIPMENT	1-1
1.1 PURPOSE AND CAPABILITIES	1-1
1.2 TECHNICAL CHARACTERISTICS	1-1
Chapter 2 INSTALLATION	2-1
2.1 INSPECTION	2-1
2.2 INPUT/OUTPUT CONNECTORS	2-1
2.3 LOCATION AND MOUNTING	2-1
2.4 WIRE SIZING	2-1
2.5 OUTLING DRAWINGS	2-1
Chapter 3 OPERATING INSTRUCTIONS	3-3
3.1 CONTROLS AND INDICATORS	3-3
3.2 SETUP AND OPERATING INSTRUCTIONS	3-3
3.3 OUTPUT OVERVOLTAGE PROTECTION	3-5
3.4 IEEE 488.2	3-5
3.5 IEEE 488.2 FUNCTION	3-8
Chapter 4 MAINTENANCE AND CALIBRATION	4-1
4.1 INTRODUCTION	4-1
4.2 PREVENTIVE MAINTENANCE	4-1
4.3 CALIBRATION AND ADJUSTMENTS	4-3

LIST OF FIGURES

FIGURE 2-1 OUTLINE DRAWING, 3300I SERIES.....	2-2
FIGURE 3-1 SERIES 3300I CONTROL AND INDICATORS.....	3-3
FIGURE 3-2 ADDRESS SWITCH.....	3-8
FIGURE 3-3 BLOCK DIAGRAM OF HARDWARE CONFIGURATION	3-10

LIST OF TABLES

TABLE 1-1 3300I SERIES ELECTRICAL CHARACTERISTICS	1-2
TABLE 1-2 3300I SERIES OUTPUT CHARACTERISTICS	1-4
TABLE 1-3 3300I SERIES IEEE CHARACTERISTICS	1-1
TABLE 2-1 OUTPUT CONNECTION DESCRIPTIONS	2-2
TABLE 2-2 INPUT CONNECTION DESCRIPTIONS	2-2
TABLE 2-3 3300I SERIES INPUT/OUTPUT CONNECTORS	2-2
TABLE 2-4 MINIMUM WIRE SIZETABLE	2-1
TABLE 3-1 SERIES 3300I CONTROLS AND INDICATORS	3-4
TABLE 4-1 PREVENTIVE MAINTENANCE SCHEDULE	4-1
TABLE 4-2 INSPECTION AND CORRECTIVE ACTION.....	4-2

Chapter 1

DESCRIPTION OF EQUIPMENT

1.1 PURPOSE AND CAPABILITIES

The Power Ten 3300I Series power supply is general purpose power supply designed specifically for laboratory test and systems applications requiring variable DC sources with good regulation and low output ripple characteristics. The Series 3300I power supply is constant current/constant voltage power supplies with an automatic crossover feature. It provides up to 1000 watts of DC power over a wide range of voltage and current levels.

1.2 TECHNICAL CHARACTERISTICS

The characteristics for the IEEE aspects of the 3300I Series are listed in Tables 1-1 through 1-3.

Table 1-1
3300 Series Electrical Characteristics

PARAMETERS	SPECIFICATIONS
PHYSICAL CHARACTERISTICS:	
Width	19.00 in.
Depth	18.50 in
Height	1.75 in.
Weight	15 lb. max.
ELECTRICAL CHARACTERISTICS:	
Input Power (Standard)	
Voltage	95 to 127 VAC, 190 to 253 VAC (Option)
Frequency	47 to 63 Hz
Phases	Single, 2-wire plus gnd
Regulation (Line or Load)	
Voltage	0.1% of max. output voltage
Current	0.1% of max. output current
Noise and Ripple (RMS)	30 mV max.
Transient Response	A 30% step load will recover to within 2% of original value within 10 ms.
Stability	$\pm 0.05\%$ of set point per 8 hr. after warm-up and at a fixed line, load and temperature.
Remote Control/Monitor	On/Off control via contact closure, 6-120 VDC or 12-240 VAC.
Power Density	2.5 Watts/cubic in.
Power Factor	.99 min. at full load
Total Harmonic	2.5% max.

Table 1-1
3300I Series Electrical Characteristics - Continued

PARAMETERS	SPECIFICATIONS
Remote Programming	
Resistive:	
Constant Voltage (0-100%)	0 - 5k ohms
Constant Current (0-100%)	0 - 5k ohms
Voltage:	
Constant Voltage (0-100%)	0 - 5 VDC
Constant Current (0-100%)	0 - 100 mV
Current:	
Constant Voltage (0-100%)	0 - 1 mA
Constant Current (0-100%)	0 - 1 mA
Remote Sensing	Terminals are provided to sense output voltage at point of load. Maximum line drop 3% of rated voltage per line.
ENVIRONMENTAL CHARACTERISTICS:	
Temperature Coefficient	0.02%/°C of max. output voltage rating for voltage set point. 0.03%/°C of max. output current rating for current set point.
Ambient Temperature	
Operating	0 to 50°C
Storage	-40° to 75°C
Cooling	Internal blowers

Table 1-2
3300I Series Output Characteristics

MODEL NUMBER	OUTPUT DC VOLTS	OUTPUT DC AMPS	OUTPUT RIPPLE (RMS)
7.575	0-7.5	75	30 mV
7.5125	0-7.5	125	30 mV
1060	0-10	60	30 mV
10100	0-10	100	30 mV
2030	0-20	30	30 mV
2050	0-30	50	30 mV
3020	0-30	20	30 mV
3033	0-30	33	30 mV
4015	0-40	15	30 mV
4025	0-40	25	30 mV
5020	0-50	20	30 mV
6010	0-60	10	30 mV
6016	0-60	16	30 mV
8006	0-80	6	50 mV
8012	0-80	12	50 mV
10010	0-100	10	50 mV
1208	0-120	8	50 mV
1507	0-150	7	50 mV

Table 1-3
3300I Series IEEE Characteristics

PARAMETERS	SPECIFICATIONS	
REMOTE CONTROL - IEEE 4888.2		<u>Resolution</u>
	<u>Accuracy</u>	
	Voltage ±0.03%	±0.1%
	Current ±0.03%	±0.1%
Data Rate	1 M byte/second	
Interconnection Path	Star, daisy chain, or linear network	
Cable Length	2 Meters per device (max.)	
ELECTRICAL CHARACTERISTICS:		
Data-Transfer Format	Byte-serial, bit-parallel using asynchronous 3-wire handshakes	
Primary Address	31 TALK, 31 LISTEN	
Maximum Devices	1 Talker and 14 Listeners at one time	
Remote Sensing	Terminals are provided to sense output voltage at point of load.	

Chapter 2

INSTALLATION

2.1 INSPECTION

Inspect the shipping carton for possible damage before unpacking the unit. Carefully unpack the equipment. Save all packing materials until inspection is complete. Verify that all items listed on the packing slips have been received. Visually inspect all exterior surfaces for broken knobs, connectors or meters. Inspect for dented or damaged exterior surfaces. External damage may be an indication of internal damage. If any damage is evident, immediately contact the carrier that delivered the unit and submit a damage report. Failure to do so could invalidate future claims.

2.2 INPUT/OUTPUT CONNECTORS

Table 2-1 lists all external connections for the 3300I Series models.

For permanently connected equipment, a readily accessible disconnect device shall be incorporated in the fixed wiring. For pluggable equipment, the socket outlet shall be installed near the equipment and shall be easily accessible.

2.3 LOCATION AND MOUNTING

The 3300I Series models are intended for mounting in a standard 19.0-inch equipment rack. Four captive screws, two on each side of the front panel, are used to secure the unit in place. Optional slide mounting is available.

NOTICE

The unit should be provided with proper ventilation. The top, rear and both sides of the unit should be free of obstructions.

Follow the instructions in paragraph 3.1.1 for setup and operation of the equipment.

Table 2-1
Output Connection Descriptions

SUPPLY TYPE	CONNECTION DESCRIPTION
Output <=60V	Bus Bar with hole for 1/4" bolt
Output >=80V	Terminal Block with 6-32 screws

Table 2-2
Input Connection Descriptions

SUPPLY TYPE	CONNECTION DESCRIPTION
3300, 3300I	Terminal Block with 6-32 screws

Table 2-3
3300I Series Input/Output Connectors

CONNECTOR	FUNCTION	CONNECTS TO
TB2 - AC TB2 - AC CHASSIS - GND	Prime Power Input (Std)* Prime Power Input (Std)*	95 to 127 VAC 47 to 63 Hz Power Source
Pos. Bus Bar Neg. Bus Bar GND Stud	Output Power Output Power	User load(s) User Load(s)
IEEE-488 Connector	IEEE-488 Connector	Standard IEEE-488 cable

*190 to 253 VAC is available as a factory option

2.4 WIRE SIZING

Care must be taken to properly size all conductors for the input and output of the power supply. Table 2-5 below gives *minimum* recommended wire size for the input. This table is derived from the National Electrical Code and is for reference only. Local laws and conditions may have different requirements. The table is for copper wire only.

Table 2-4
Minimum Wire Size Table

SIZE	TEMPERATURE RATING OF COPPER CONDUCTOR			
	60 °C	75 °C	85 °C	90 °C
	TYPES	TYPES	TYPES	TYPES
AWG MCM	RUW, T, TW, UF	FEPW, RH, RHW, RUH, THW, THWN, XHHW, USE, ZW	V, MI	TA, TBS, SA, AVB, SIS, FEP, FEPB, RHH, THHN, XHHW
	CURRENT RATING			
14	20	20	25	25
12	25	25	30	30
10	30	35	40	40
8	40	50	55	55
6	55	65	70	75
4	70	85	95	95
3	85	100	110	110
2	95	115	125	130
1	110	130	145	150
0	125	150	165	170

2.5 OUTLING DRAWINGS

The following page (figure 2-1) shows the outlines and overall dimensions for 3300 product line.

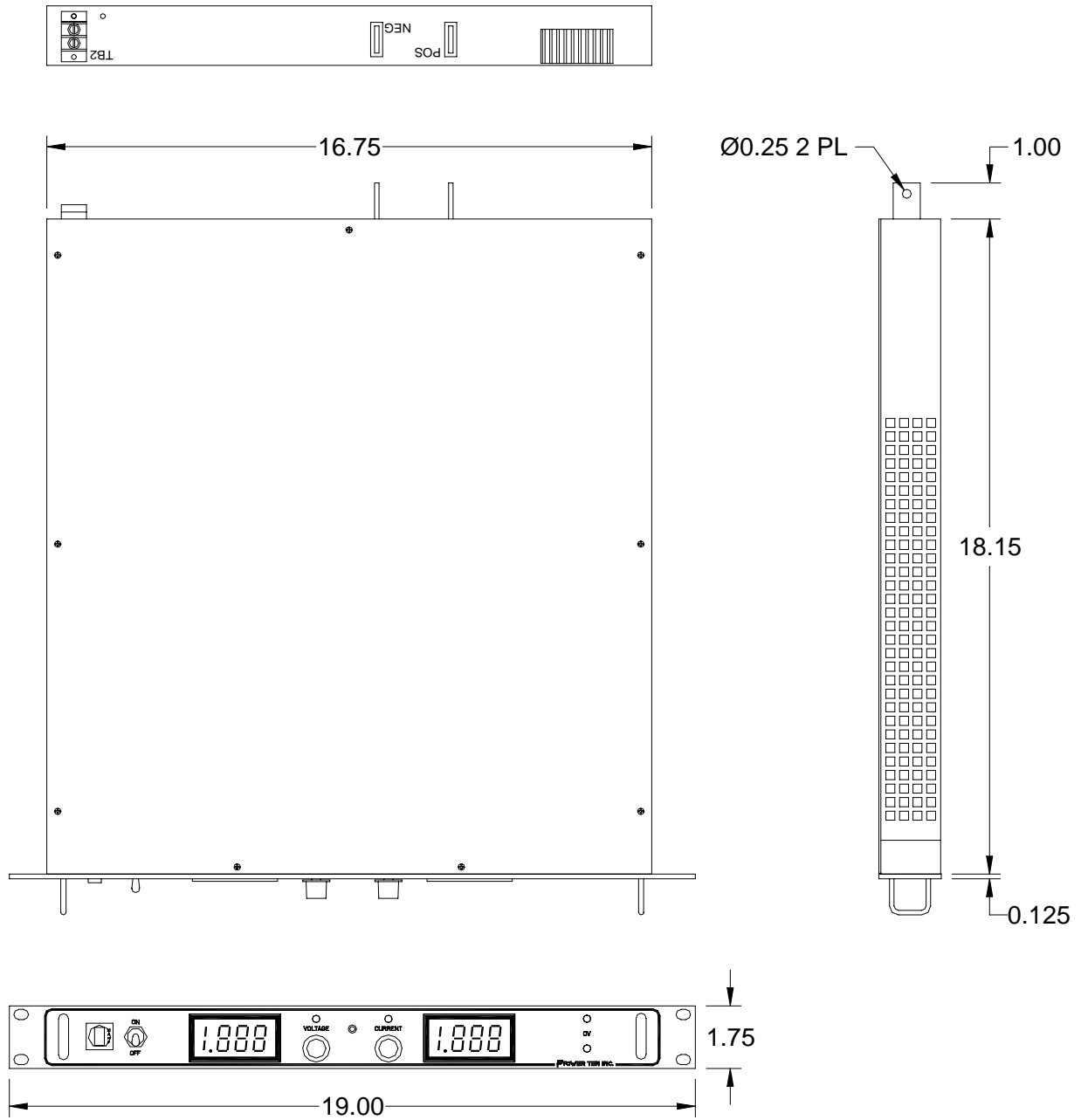

Figure 2-1
Outline Drawing, 3300I Series

Chapter 3

OPERATING INSTRUCTIONS

3.1 CONTROLS AND INDICATORS

Front panel controls and indicators for the 3300I Series are identified in Figure 3-1 with index numbers keyed to Table 3-1. Table 3-1 provides a description of all operator controls and indicators.

3.2 SETUP AND OPERATING INSTRUCTIONS

The following paragraphs provide setup and operating procedures for the 3300I Series.

The power supply may be configured via TB1 for different operating configurations; local and remote sensing is provided using switch S1 in the back of the unit. Placing the switch S1 in the REM position enables the power supply to sense the output voltage at the point of the load and compensate for any voltage drop across the bus bars or the output cables. The load must be wired to TB1 (Vs+, Vs-) for remote sensing.

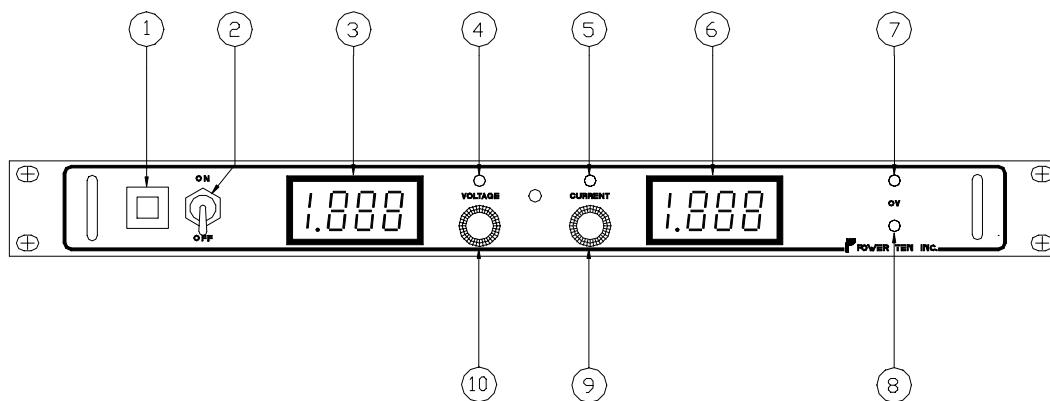

Figure 3-1
Series 3300I Control and Indicators

Table 3-1
Series 3300I Controls and Indicators

FIGURE & INDEX NO	CONTROL/INDICATOR	FUNCTION
3-1		
1	Circuit Breaker	Provides fault protection
2	POWER Switch	Applies AC power to the power supply.
3	VOLTAGE Meter	Measures voltage output
4	Voltage Mode Indicator	Indicates the power supply is operating in the voltage mode.
5	Current Mode Indicator	Indicates the power supply is operating in the voltage mode.
6	CURRENT Meter	Measures current output
7	OVERVOLTAGE Indicator	Indicates output voltage has exceeded preset level and power supply output is turned off.
8	Overvoltage Potentiometer	Adjusts overvoltage trip level.
9	Output Current Control	Adjusts current control to desired level.
10	Output Voltage Control	Adjusts voltage control to desired level.

3.3 OUTPUT OVERVOLTAGE PROTECTION

If the power supply is equipped with an overvoltage crowbar, the front panel will contain overvoltage adjustment. This potentiometer may be adjusted through an access hole in the front panel.

For trip levels less than the maximum output voltage or to check the overvoltage circuitry, perform the following procedure.

1. Set the potentiometer fully clockwise.
2. Adjust the power supply output voltage to the desired trip level.
3. Slowly adjust the potentiometer counterclockwise until overvoltage is tripped.

3.4 IEEE 488.2

The mode switch (S2), located on the rear panel, is used to switch between the manual mode and the IEEE mode. The power supply must be OFF when switching from one mode to the other.

Below are two lists of commands: (1) Programmable Set Functions which can be sent to the GPIB power supply, and (2) Read Back Functions which enable the available data to be read back.

Programmable Set Functions

Output On/Off
Set Output Voltage
Set Output Current
Maximum Rated Voltage
Maximum Rated Current
Wait to Complete Operation
Reset Power Supply State

Read Back Functions

Actual Voltage
Actual Current
Read ID
Read Status Register
Read Operation Complete
Self-Test Error Code

All IEEE 488.2 programmable common routines can be categorized under the following headings.

1. Simple Device I/O
 - Send
 - Receive
2. Multiple Device I/O
 - Sendlist
3. Simple Device Control
 - Device Clear
 - Read Status Byte

In addition to the IEEE 488.2 routines and function, Power Ten power supplies respond to the following common commands and queries.

<u>Command Mnemonics</u>	<u>Description</u>
CST ON	Controls the ON state of the power supply. The response is "ST ON."
CST OFF	Controls the OFF state of the power supply. The response is "ST OFF."
SRVT xx.xxx	Sets the power supply output at the rated voltage. This command must be stated prior to WVA and WCA. Note that the value should match the voltage rating of the power supply. Incorrect setting of this command will result in reading back wrong voltages.
SRCT xx.xxx	Sets the power supply output current at the rated current. This command must be stated prior to WVA and WCA. Note that this value should match the current rating of the power supply. Incorrect setting of this command will result in reading back incorrect current.
WVA xx.xxx	Sets the output voltage from 00.00 to a desired value.
WCA xx.xxx	Sets the output current from 00.00 to a desired value.

<u>Command Mnemonics</u>	<u>Description</u>
RVA	Reads the power supply's actual voltage output. The response is VA xx.xxx.
RCA	Reads the power supply's actual current output. The response is CA xx.xxx.
*IDN?	Commands controller to send its identity string. The response is: Power Ten model number.
*CLS	Clears both the standard event status and serial POLL status registers.
*WAI	Forces the controller to complete all pending operations.
*RST	Clears the standard event status register and initializes the GPIB interface controller.
*ESE?	Commands the controller to send the content of the standard event status enable register.
*ESE XXX	Sets the standard event status enable register to a new value.
*SRE?	Directs the controller to send the content of the status register.
*SRE XXX	Sets status enable register to new value.
*STB?	Directs the controller to send the last command from status register.
*OPC?	Directs controller to send the status of the operation complete bit in the standard event status register. The response is 1.
*OPC	Sets the status of the operation complete bit in the standard event status register TRUE. If proper bits in the standard event enable and status enable registers are set, an SRQ is issued to the controller.

The IEEE 488.2 Address Switch is located on the rear panel, next to the IEEE 488.2 connector. The address switch, see Figure 3-2, is an eight bit DIP-switch with the function as explained below:

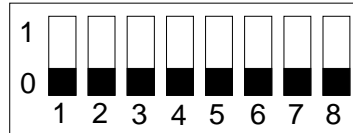

- | | |
|------------------|------------|
| 1. Address bit 0 | 6 Not Used |
| 2. Address bit 1 | 7 Not Used |
| 3. Address bit 2 | 8 Not Used |
| 4. Address bit 3 | |
| 5. Address bit 4 | |

Figure 3-2
Address Switch

The position of the first five switches determines the GPIB address of the power supply. The address switch has five binary weighted positions (1, 2, 4, 8, 16). The desired address is selected by turning on or off different combinations of switches. The address switch register is read by the microprocessor upon power-up. For example, address 1 is bit 0-on, and all other bits off.

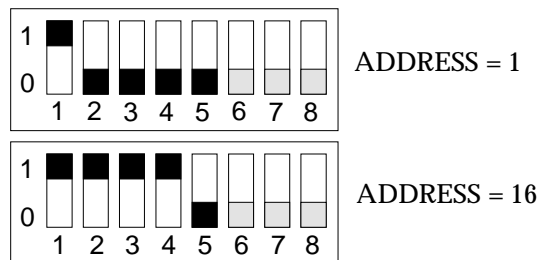

3.5 IEEE 488.2 FUNCTION

The IEEE 488.2 parallel interface controller in Power Ten power supplies complies with IEEE 488.2-1987 protocols and IEC 625 standards. The controller is compatible with all A-488.2 interface functions, such as, Source Handshake (SH1), Acceptor Handshake (AH1), Basic Talker (T6), Basic Listener (L4), Service Request (SR1), Remote Local (RL1), Parallel Poll (PP1), Controller in Charge (CIC), Electrical Interface E1 (Open Collector).

3.5.1 Functional Description.

Microprocessor

This block consists of the INTEL 8085, the 10 MHz crystal oscillator and power-up reset circuitry. See Figure 3-3 for a block diagram of the hardware configuration. The 8085 will divide the 10 MHz oscillator by 2 and run at 5 MHz. A 5 MHz clock is output from the chip for use in other circuits. In this design it is connected to the 9914A (GPIB controller chip). The resistor and capacitor provide the power-up reset pulse. This is also conditioned by the 8085 and provided as a CMOS compatible output.

Latch

The latch is used to capture the upper 8 bits using the ALE control signal provided by the microprocessor. These upper 8 bits are combined with the lower 8 bits of the address bus provided from the 8085.

EPROM and RAM

The EPROM and RAM circuitry receive address information from the CAXX bus and interface directly with the 8085 ADX bus. The upper bits of the address bus are decoded by the micro address decode block. This block provides chip select lines and read/write control lines to the system memory (EPROM and RAM). The EPROM is located at addresses 0000H through 3FFFH. On power-up (after reset), the microprocessor starts executing instructions found at address 0000H. The RAM addresses (16k bytes) are located in the upper part of the address space (C000H to FFFFH).

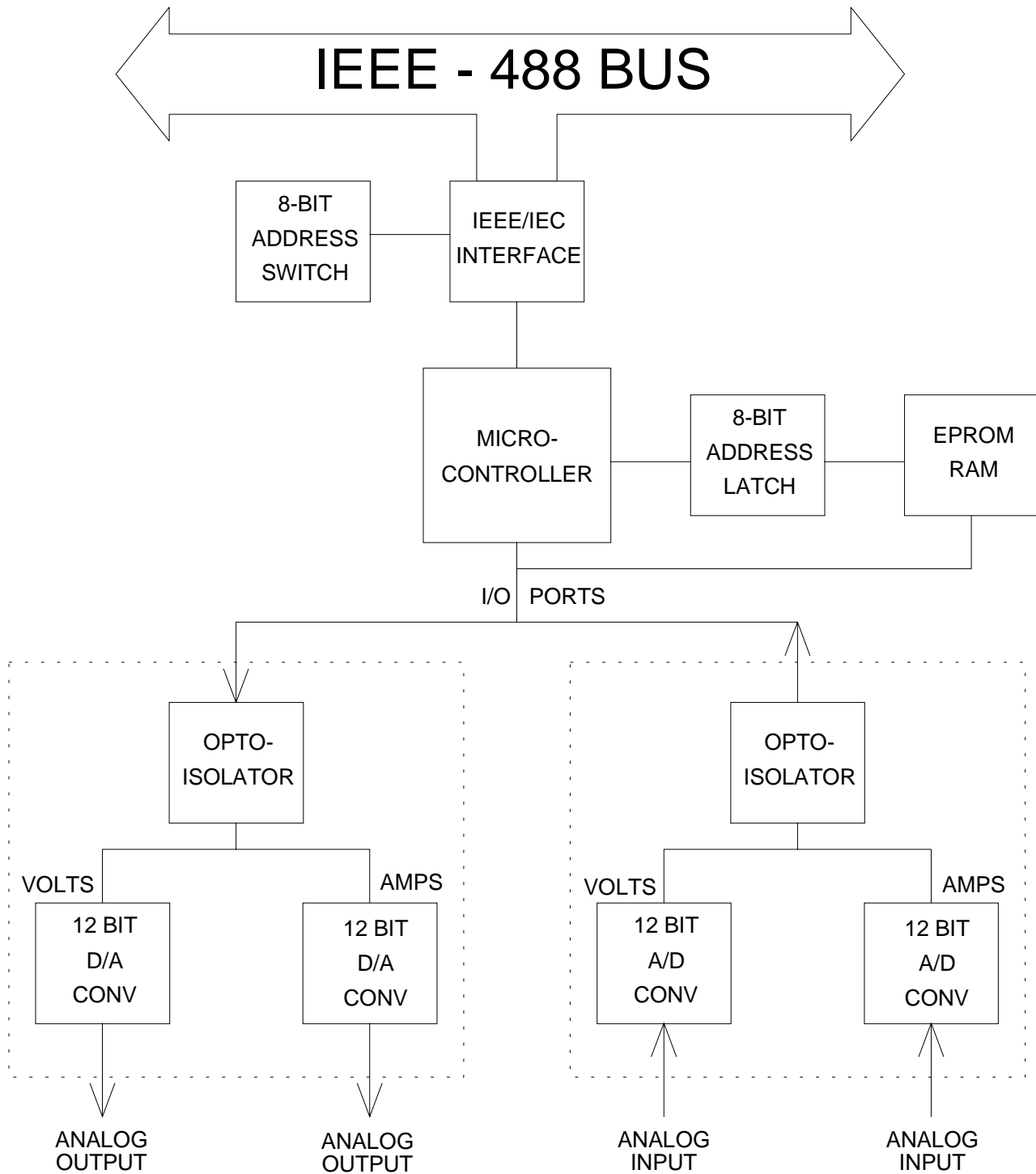

Figure 3-3
Block Diagram of Hardware Configuration

Chapter 4

MAINTENANCE AND CALIBRATION

4.1 INTRODUCTION

This chapter contains preventive and corrective maintenance information for the 3300I Series.

WARNING

All maintenance that requires removal of the cover of the unit should only be done by properly trained and qualified personnel. Hazardous voltages exist inside the unit.

4.2 PREVENTIVE MAINTENANCE

Preventive maintenance for the Series 3300I consists of scheduled inspection and cleaning.

Schedule

Table 4-1 lists the preventive maintenance routines and the recommended performance intervals.

Inspection

Table 4-2 lists the visual inspection checks to be performed. It also indicates the corrective action to be taken.

Cleaning

Cleaning requirements are based on the need established during inspection. If cleaning is required, follow the instruction listed in the corrective action column of Table 4-2.

Table 4-1
Preventive Maintenance Schedule

PREVENTIVE MAINTENANCE ROUTINE	RECOMMENDED PERFORMANCE INTERVAL
Inspection	Annual
Cleaning	As Required

Table 4-2
Inspection and Corrective Action

ITEM	INSPECT FOR	CORRECTIVE ACTION
External Connector plugs and jacks	Looseness, bent or corroded contacts, damage or improper seating in mating connector	Clean contacts with solvent moistened cloth, soft bristle brush, small vacuum or low compressed air. Replace connectors damaged, deeply corroded, or improperly seated in mating connector.
Chassis, blower & extruded heatsinks	Dirt and Corrosion	Clean with cloth moistened with soapy water.
External Electrical Wiring	Broken, burned or pinched wire; frayed, worn or missing insulation	Repair or replace defective wires.
External Solder Connections	Corrosion, loose, cracked, or dirty connections	Clean and resolder connections.
Dirt and moisture buildup	Short circuits, arcing, corrosion, overheating	Clean as required.
Front panel controls and meters	Dirt and corrosion	Clean with cloth moistened with soapy water. Use a Kimwipe tissue and glass cleaning compound to clean the meter faces.

4.3 CALIBRATION AND ADJUSTMENTS

To perform the following calibration and adjustment procedures, the cover must be removed from the power supply. Because removal of the cover allows access to potentially hazardous power voltages (up to 253 VAC and 358 VDC) and because of the importance of accurate readings to performance, only technically trained personnel should perform calibration procedures.

WARNING

Hazardous voltages (up to 253 VAC and 358 VDC) are present during equipment operations. Press switch to OFF position and disconnect power cord from power source. Allow a minimum three minutes for discharge of storage capacitance before removing the cover or performing any maintenance function. Wear safety glasses with cover removed.

Voltage Zero Calibration.

The voltage control circuit (U108D) zero is adjusted with R198. The following sequence is recommended.

- a) Set the switch to "LOC" position.
- b) Connect resistive load and DMM across output terminals of power supply. Set DMM to read DC volts and approximately 200 millivolt range.
- c) Set current control potentiometer full clockwise.
- d) Apply power to power supply.
- e) Adjust R198 until the power supply output voltage starts to increase in the normal polarity. Reverse adjustment direction of R198 until output voltage at the bus bars decreases to zero reading on the DMM. The output of U108, pin 14, must read zero millivolts. This is the zero calibration.
- f) Remove power from power supply.
- g) Remove resistive load and DMM from power supply output terminals.

Voltage Full-Scale Calibration

Full-scale voltage calibration is adjusted with R203. The following sequence is recommended.

- a) Connect a resistive load across output terminals.
- b) Connect a DMM between output terminals. Set DMM to DC volts and the scale to read maximum rated power supply voltage.
- c) Connect a second DMM between U108C, pin 8, and return. Set DMM to DC volts and scale to read 5.00 volts.

- d) Rotate current control to maximum clockwise.
- e) Apply power to power supply.
- f) Rotate voltage control for 5.00 volt reading to DMM.
- g) Adjust R203 until output voltage reading is 100% of rated output voltage DC between TB1-1 and TB1-2.
- h) Remove power from power supply.
- i) Remove DMM's and resistive load from power supply terminals.

Current Zero Calibration

The current feedback scaler circuit (U102B) zero is adjusted with R140. The following sequence is recommended.

- a) Connect a resistive load and DMM across the output terminals of the power supply. Set DMM to read DC volts and approximately 200 millivolt range.
- b) Set voltage control potentiometer on front panel fully clockwise to read the maximum output voltage with the load removed.
- c) Adjust 140 until the output at pin 7 from U102B reads zero on the DMM.
- d) Remove power from power supply.

Current Full-Scale Calibration

Full-scale current calibration is adjusted with R136. The following sequence recommended.

- a) Connect an external calibrated current shunt between the power supply negative output and a resistive load bank capable of full-rated power. (Optionally, the shunt may be connected between the power supply positive and negative output bus bars.)
- b) Connect DMM across current shunt sensing terminals.
- c) Connect a DMM between U102, pin 7, and return. Set to 200 millivolt range.
- d) Set front panel voltage control potentiometer fully clockwise.
- e) Apply power to power supply.
- f) Adjust R136 until U102, pin 7, reads maximum 5.0 V at full-load current.
- g) Remove power from power supply.
- h) Reconfigure power supply for normal operation.

Meter Zero Calibration

The zero set for both voltage and current front panel meter is automatic.

Meter Full-Scale Calibration

The full-scale adjustment for the digital panel meters M1 and M2 is adjusted by R8 and R11, respectively, of the display assembly 10-010-086-00. R8 is for full-scale current meter calibration and R11 is for full-scale voltage meter calibration. Both resistors are accessible from inside the power supply when the cover is removed.

To calibrate for full-scale voltage or current, adjust the power supply to maximum rated output voltage (or current) using external calibrated meters and adjust the appropriate meter to correspond to the rated output voltage or current.

IEEE Voltage Calibration.

- a) Set switch S2, which is accessed through the back panel, to the IEEE position.
- b) Set the command WVA to 0.00 and WCA to maximum current rating over the GPIB bus, while monitoring the output voltage with a voltage meter.
- c) Adjust potentiometer R39 (zero-voltage adjust) till the meter reads 0.00 volt. This sets the zero-voltage adjust in the IEEE mode.
- d) Set the command WVA to maximum voltage rating and WCA to maximum current rating. Note, if the power supply is in the current mode, reduce the output load until the power supply switches to the voltage mode.
- e) Adjust potentiometer R41 (Full-Scale Voltage Adjust) until the meter reads the correct full-scale voltage rating.

IEEE Current Calibration.

- a) Set the command WCA to 0.00 and WVA to maximum voltage rating.
- b) Adjust potentiometer R31 (zero-current adjust) until the meter across the shunt (in series with the output load) reads 0.00.
- c) Set the command WCA to maximum current rating and WVA to maximum voltage rating. Note, if the power supply is in voltage mode increase load until it switches to the current mode.
- d) Adjust potentiometer R33 (full-scale current adjust) until the meter across the output shunt reads full-scale current rating.

IEEE Voltage/Current Readback Calibration.

- a) Set the command WVA to maximum voltage rating and the WCA to any number smaller than the current rating. If necessary, reduce load to bring power supply into voltage mode.
- b) Send the voltage query command RVA repeatedly over the bus. Adjust potentiometer R49 until the query command reads back the actual voltage rating. This calibrates the voltage readback in IEEE mode.
- c) Set the command WCA to maximum current rating and the WVA to any arbitrary number. If necessary, increase load to bring the power supply into current mode.

- d) Send the current query command RCA repeatedly over the bus. Adjust potentiometer R49 until it reads back the actual current rating. This calibrates the current readback in IEEE mode.